

Amphenol® 348 Series High Density Connectors

12-093-6



MIL-C-81511, Series I, II

Amphenol

Table of Contents

348 Series	Page No.
High Density Connectors	1
Specifications	2
Insert Availability and Identification, Alternate Positions	3
Insert Arrangements	4, 5
348-36E (M81511/26E), 348-46E (M81511/06E) straight plug	6
348-30E (M81511/21E), 348-40E (M81511/01E) square flange receptacle	7
348-33E (M81511/23E), 348-43E (M81511/03E) single hole mounting receptacle	8
348-31E (M81511/25E), 348-41E (M81511/05E) cable receptacle	9
Accessories – Cable Clamp, Dummy Receptacle	10
Accessories – Protection Caps	11
Contacts – Power and Shielded	12
Contact Sealing Plugs, Application Tools	13
How to Order	14, 15
Sales Office Listing	

This catalog covers Amphenol® 348 Series Connectors. For additional information on Amphenol® products, or for special application requirements, contact your local Amphenol sales office or -

Amphenol Corporation
Amphenol Aerospace
40-60 Delaware Avenue
Sidney, New York 13838-1395
Telephone: 607-563-5011
Fax: 607-563-5157
www.amphenol-aerospace.com

Data printed in blue pertains only to Series I, Long.
Data printed in black pertains to Series II, Standard or both
Series I and II as the catalog situation dictates.

Amphenol Aerospace is a certified ISO 9001 Manufacturer.

348 Series

high density connectors

**MIL-C-81511
Series I**



straight plug



**square flange
receptacle**



**single hole
mounting
receptacle**

**MIL-C-81511
Series II**



straight plug



**square flange
receptacle**



**single hole
mounting
receptacle**

The Amphenol® 348 Series connector provides reliability and high contact density. Qualified to MIL-C-81511, these connectors can accommodate a minimum of three circuits to a maximum of one hundred and fifty five circuits.

Amphenol® 348 Series connectors are available in two basic constructions: Long (Series I) and Standard (Series II). The Series I features 100% scoop-proof construction (potential contact damage minimized by recessed pins). Series II, Standard connectors are scoop-proof when the pin contacts are specified in the receptacle shell only.

Each construction, Series I and Series II, features a single one-piece molded dielectric retention system that locks the contacts in place. The contacts are crimp type, either power or shielded, and available in sizes 12, 16, 20 and 23-28 or 23-22 with wire size accommodations from 12 through 32 AWG.

The Amphenol® 348 Series is a lightweight, compact connector offered in 4 shell styles: straight plug, square flange receptacle, single hole mounting receptacle and cable receptacle. It is environmentally resistant and will operate at sea level to a voltage of 600 VAC (RMS). It will perform under high temperature vibration, testing through 150°C (see specifications on page 2).

348 Series specifications

Materials and Finishes:

pin contact (standard) - copper base alloy, gold plated per 50 micro inches min. per MIL-G-45204 over suitable underplate.

socket contact (standard) - copper base alloy, gold plated per MIL-G-45204 over suitable underplate. Hood material is stainless steel.

shell - aluminum alloy finish for E class connectors - cadmium plate over suitable underplate.

inserts - high grade dielectric material

Maintenance Aging - All contacts shall be removed and installed for 10 cycles. After 10th cycle, contact insertion and retention forces are as shown in table:

Contact Size	Unlocked			Locked Retention Force lbs.
	Insertion Force lbs.	Removal Force lbs.		
	Maximum	Minimum	Maximum	Minimum
23*	12	3	17	10
20	20	3	23	15
16	25	4	23	25
12	30	5	23	25

* Applies to both 23-28 and 23-22 contact sizes.

Durability - After 500 mating-unmating cycles at a maximum rate of 300 cycles per hour, connectors shall not show any damage detrimental to the operation of the connector.

Corrosion - After salt spray testing per method 1001, condition B, MIL-STD-1344 connectors shall show no exposure of basis metal which will affect performance.

Dielectric Withstanding Voltage - Connectors shall show no evidence of breakdown or flashover when subjected to the test voltages and altitudes specified in table. Corona shall not be considered as breakdown. (Sea level tests performed per method 3001 of MIL-STD-1344; Altitude tests per method 1005, condition C, of MIL-STD-202).

Test Voltage (ac, rms, not working voltage)

Simulated Altitude Condition	Mated	Unmated
Sea Level	1800	1500
50,000 feet	1000	550
70,000 feet	1000	375
110,000 feet	1000	200

Maximum recommended working voltage, ac, rms

Condition	
Sea Level	600
50,000 feet	300
70,000 feet	300
110,000 feet	300

Fluid Immersion - Unmated connectors shall be immersed fully in fluids specified in table. At least one connector must be immersed in each fluid type. After the immersion period and a drying period of 1 hour, the connectors must remain completely functional.

Fluids for fluid immersion

Connector Class	Fluids
E	MIL-H-5606 MIL-L-23699

Moisture Resistance - Mated connectors shall have an insulation resistance of 500 megohms or greater at 25°C after moisture testing per MIL-STD-202, method 106.

Thermal Shock - Connectors shall remain completely functional after being subjected to the temperature extremes specified below:

Low Temperature -65°C + 0° - 3°	High Temperature +150°C + 3° - 0°
Test Condition*	F

* Tested in accordance with method 1003, of MIL-STD-1344 per test conditions listed.

Vibration - Connectors shall undergo vibration testing per method 2005, test condition IV, MIL-STD-1344 in low and high temperature extremes of preceding table with all contacts connected in series, and a current flow of 100 milliamperes. There shall be no circuit interruption longer than 1 micro-second.

Physical Shock - The application of 1/2 sine-wave transient shock impulses of 50 gravity units to 3 planes for 11 milli-seconds, with test voltage applied to series connected contacts, shall result in no discontinuity longer than 1 micro-second. Connectors shall not be damaged, parts shall not become loose.

Temperature Life - Mated connectors shall perform satisfactorily after being subjected to ambient temperatures specified, per class for 1000 hrs.

EMI Shielding Effectiveness - As measured in a triaxial EMI leakage tester, connector shells with grounding springs shall exhibit a radio frequency attenuation equal to or greater than the following:

Frequency (MHz)	Leakage Atten. (db)
100	65
300	55
800	45
1000	45

348 Series

insert availability and identification alternate positions

Insert Availability

Insert Arrangement		MS Code	Service Rating	Total Contacts	Contact Size			
Series I	Series II				23*	20	16	12
8-04	8-04	A01	I	4	4			
10-03	10-03	B03	I	3			3	
10-05	10-05	B02	I	5		5		
10-12	10-12	B01	I	12	12			
14-04	14-04	D04	I	4				4
14-09	14-09	D03	I	9			9	
14-19	14-19	D02	I	19		19		
14-37	14-37	D01	I	37	37			
16-07	16-07	E04	I	7				7
16-14	16-14	E03	I	14			14	
16-27	16-27	E02	I	27		27		
16-55	16-55	E01	I	55	55			
18-09	18-09	F04	I	9				9
18-21	18-21	F03	I	21			21	
18-38	18-38	F02	I	38		38		
18-85	18-85	F01	I	85	85			
20-11	NA	G04	I	11				11
20-24	NA	G03	I	24			24	
20-45	NA	G02	I	45		45		
20-92	NA	G01	I	92	92			
22-14	NA	H04	I	14				14
22-32	NA	H03	I	32			32	
22-61	NA	H02	I	61		61		
22-121	NA	H01	I	121	121			
24-19	NA	J04	I	19				19
24-41	NA	J03	I	41			41	
24-74	NA	J02	I	74		74		
24-155	NA	J01	I	155	155			

* Applies to both 23-28 and 23-22 contact sizes.

Alternate Positions

To avoid cross-plugging problems in applications requiring the use of more than one 348 Series connector of the same size and arrangement, alternate positions are available as indicated in the charts below.

A plug with a given position number (1 through 6) will mate with a receptacle with the same position number. The angular rotation A, B, C or D is the same whether the connector has pin or socket inserts. Inserts are not rotated in relation to the master key/keyway.

Shown below is a view from the front face of a receptacle. The view for the front face of a plug is the same except the direction of rotation of the angles is opposite of that shown for the receptacle.

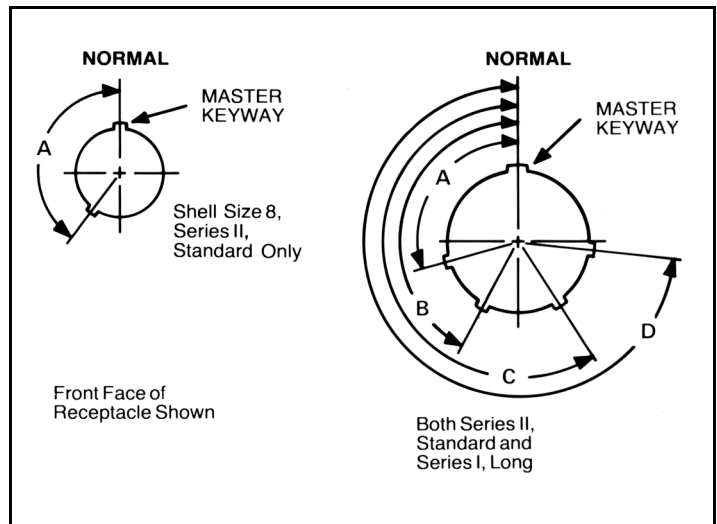

Series II, Standard

Key and Keyway Position	Angular Location								
	Shell Size 8	Shell Size 10 and 14				Shell Size 16 and 18			
	A°	A°	B°	C°	D°	A°	B°	C°	D°
1	128	105	140	215	265	105	140	215	265
2	190	102	132	248	320	18	149	192	259
3	205	80	118	230	312	92	152	222	342
4	220	35	140	205	275	84	152	204	334
5	235	64	155	235	304	24	135	199	240
6	250	35	115	220	270	98	152	268	338

Series I, Long

Key and Keyway Position	Angular Location											
	Shell Size 8				Shell Size 10 and 14				Shell Size 16, 18, 20, 22, 24			
	A°	B°	C°	D°	A°	B°	C°	D°	A°	B°	C°	D°
1	105	140	215	265	95	141	208	236	80	142	196	293
2	102	132	248	320	113	156	182	292	135	170	200	310
3	80	118	230	312	90	145	195	252	49	169	200	244
4	35	140	205	275	53	156	220	255	66	140	200	257
5	64	155	234	304	119	146	176	298	62	145	180	280
6	91	131	197	240	51	141	184	242	79	153	197	272

348 Series

insert arrangements

front face of pin inserts illustrated

The insert arrangements on this page (shell sizes 8 thru 18) are available in both Series I, Long and Series II, Standard.



Insert Arrangement	8-04	10-03	10-05	10-12	14-04
Number of Contacts	4	3	5	12	4
Contact Size	23*	16	20	23*	12



Insert Arrangement	14-09	14-19	14-37	16-07	16-14
Number of Contacts	9	19	37	7	14
Contact Size	16	20	23*	12	16



Insert Arrangement	16-27	16-55	18-09	18-21
Number of Contacts	27	55	9	21
Contact Size	20	23*	12	16



Insert Arrangement	18-38	18-85
Number of Contacts	38	85
Contact Size	20	23*

*Applies to both 23-28 and 23-22 contact sizes.

Contact Legend				
	12	16	20	23*

348 Series insert arrangements

front face of pin inserts illustrated

The insert arrangements on this page (shell sizes 20 thru 24) are available only in Series I, Long.

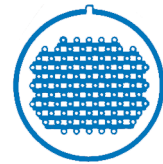
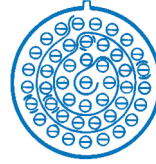
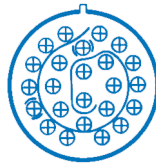

Insert Arrangement
Number of Contacts
Contact Size

20-11
11
12

20-24
24
16

20-45
45
20

20-92
92
23*

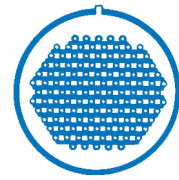
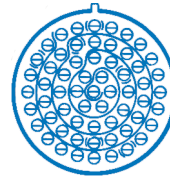
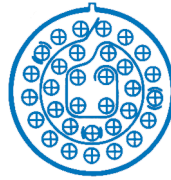
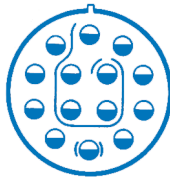

Insert Arrangement
Number of Contacts
Contact Size

22-14
14
12

22-32
32
16

22-61
61
20

22-121
121
23*

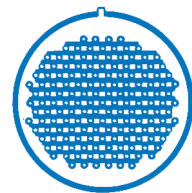
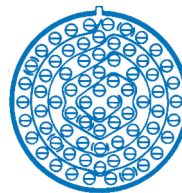
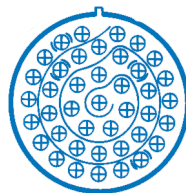
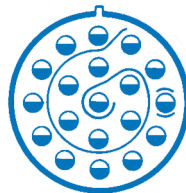

Insert Arrangement
Number of Contacts
Contact Size

24-19
19
12

24-41
41
16

24-74
74
20

24-155
155
23*

*Applies to both 23-28 and 23-22 contact sizes.

●	⊕	⊖	•
12	16	20	23*

348-36E (M81511/26E) 348-46E (M81511/06E) straight plug

Blue designates Series I, Long
Black designates Series II, Standard

*348-36EXX-XX
*M81511/26EXXXX
*348-46EXX-XX
*M81511/06EXXXX

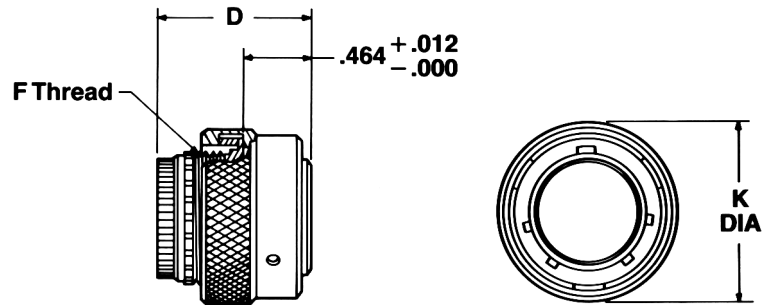

Shell Size	Plug Front View	Plug Side View	
	K Dia. Max.	D Max.	F Thread Class 2A
8	.850	1.445	.5000-28 UNEF
10	.975	1.445	.6250-28 UN
14	1.225	1.445	.8750-28 UN
16	1.350	1.445	1.0000-28 UN
18	1.475	1.445	1.1250-28 UN
20	1.624	1.525	1.2500-28 UN
22	1.749	1.525	1.3750-28 UN
24	1.874	1.525	1.5000-28 UN

Shell Size	Plug Front View	Plug Side View	
	K Dia. Max.	D Max.	F Thread Class 2A
8	.850	1.100	.5000-28 UNEF
10	.975	1.100	.6250-28 UN
14	1.225	1.100	.8750-28 UN
16	1.350	1.100	1.0000-28 UN
18	1.475	1.100	1.1250-28 UN

All dimensions for reference only.

All dimensions in inches and shown as Max. unless otherwise indicated.

* To complete order number see pages 14 and 15.

348-30E (M81511/21E) 348-40E (M81511/01E) square flange receptacle

Blue designates Series I, Long
Black designates Series II, Standard

*348-30EXX-XX
*M81511/21EXXXX
*348-40EXX-XX
*M81511/01EXXXX

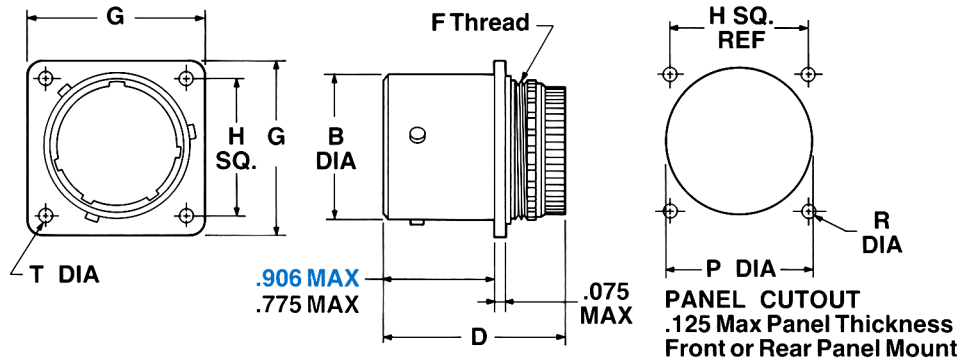

Shell Size	Receptacle Front View			Receptacle Side View			Panel Cutout View	
	G Max.	H $\pm .005$ Square	T Dia. $+.000$ $-.010$	B Dia. Max.	D Max.	F Thread Class 2A	P Dia. $\pm .005$	R Dia. $+.000$ $-.010$
8	.820	.594	.126	.553	1.471	.5000-28 UNEF	.635	.132
10	.945	.719	.126	.678	1.471	.6250-28 UN	.760	.132
14	1.133	.906	.126	.928	1.471	.8750-28 UN	1.010	.132
16	1.258	.969	.126	1.054	1.471	1.0000-28 UN	1.135	.132
18	1.351	1.062	.126	1.178	1.471	1.1250-28 UN	1.260	.132
20	1.475	1.156	.126	1.303	1.551	1.2500-28 UN	1.385	.132
22	1.570	1.250	.126	1.428	1.551	1.3750-28 UN	1.510	.132
24	1.711	1.375	.153	1.553	1.551	1.5000-28 UN	1.635	.159

Shell Size	Receptacle Front View			Receptacle Side View			Panel Cutout View	
	G Max.	H $\pm .005$ Square	T Dia. $+.000$ $-.010$	B Dia. Max.	D Max.	F Thread Class 2A	P Dia. $\pm .005$	R Dia. $+.000$ $-.010$
8	.820	.594	.126	.553	1.340	.5000-28 UNEF	.635	.132
10	.945	.719	.126	.678	1.340	.6250-28 UN	.760	.132
14	1.133	.906	.126	.928	1.340	.8750-28 UN	1.010	.132
16	1.258	.969	.126	1.054	1.340	1.0000-28 UN	1.135	.132
18	1.351	1.062	.126	1.178	1.340	1.1250-28 UN	1.260	.132

All dimensions for reference only.

All dimensions in inches and shown as Max. unless otherwise indicated.

* To complete order number see pages 14 and 15.

348-33E (M81511/23E) 348-43E (M81511/03E) single hole mounting receptacle

Blue designates Series I, Long
Black designates Series II, Standard

*348-33EXX-XX
*M81511/23EXXX
*348-43EXX-XX
*M81511/03EXXX

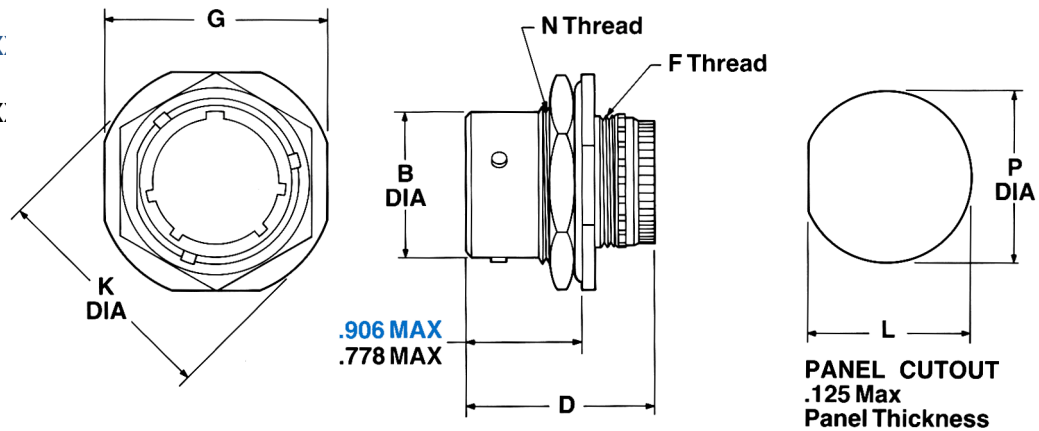

Shell Size	Receptacle Front View		Receptacle Side View				Panel Cutout View	
	G Max.	K Dia. Max.	B Dia. Max.	D Max.	F Thread Class 2A	N Thread Class 2A	L ±.005	P Dia. ±.005
8	.989	1.072	.553	1.471	.5000-28 UNEF	.6250-20 UN	.605	.635
10	1.114	1.197	.678	1.471	.6250-28 UN	.7500-20 UNEF	.730	.760
14	1.401	1.510	.928	1.471	.8750-28 UN	1.0000-20 UNEF	.980	1.010
16	1.526	1.635	1.054	1.471	1.0000-28 UN	1.1250-20 UN	1.105	1.135
18	1.651	1.745	1.178	1.471	1.1250-28 UN	1.2500-20 UN	1.230	1.250
20	1.776	1.870	1.303	1.551	1.2500-28 UN	1.3750-20 UN	1.355	1.385
22	1.901	1.995	1.428	1.551	1.3750-28 UN	1.5000-20 UN	1.480	1.510
24	2.026	2.120	1.553	1.551	1.5000-28 UN	1.6250-20 UN	1.605	1.635

Shell Size	Receptacle Front View		Receptacle Side View				Panel Cutout View	
	G Max.	K Dia. Max.	B Dia. Max.	D Max.	F Thread Class 2A	N Thread Class 2A	L ±.005	P Dia. ±.005
8	.989	1.072	.553	1.340	.5000-28 UNEF	.6250-20 UN	.605	.635
10	1.114	1.197	.678	1.340	.6250-28 UN	.7500-20 UNEF	.730	.760
14	1.401	1.510	.928	1.340	.8750-28 UN	1.0000-20 UNEF	.980	1.010
16	1.526	1.635	1.054	1.340	1.0000-28 UN	1.1250-20 UN	1.105	1.135
18	1.651	1.745	1.178	1.340	1.1250-28 UN	1.2500-20 UN	1.230	1.260

All dimensions for reference only.
All dimensions in inches and shown as Max. unless otherwise indicated.
* To complete order number see pages 14 and 15.
NOTE: The jam nut has a special decoupling resistant feature.

348-31E (M81511/25E) 348-41E (M81511/05E) cable receptacle

Blue designates Series I, Long
Black designates Series II, Standard

*348-31EXX-XX
*M81511/25EXXXX
*348-41EXX-XX
*M81511/05EXXXX

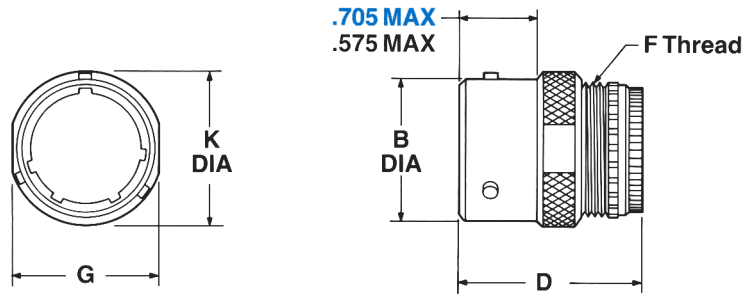

Shell Size	Receptacle Front View		Receptacle Side View		
	G Max.	K Dia. Max.	B Dia. Max.	F Thread Class 2A	D Max.
8	.565	.780	.553	.5000-28 UNEF	1.471
10	.690	.900	.678	.6250-28 UN	1.471
14	.940	1.150	.928	.8750-28 UN	1.471
16	1.066	1.280	1.054	1.0000-28 UN	1.471
18	1.190	1.400	1.178	1.1250-28 UN	1.471
20	1.315	1.525	1.303	1.2500-28 UN	1.551
22	1.440	1.650	1.428	1.3750-28 UN	1.551
24	1.565	1.775	1.553	1.5000-28 UN	1.551

Shell Size	Receptacle Front View		Receptacle Side View		
	G Max.	K Dia. Max.	B Dia. Max.	F Thread Class 2A	D Max.
8	.565	.780	.553	.5000-28 UNEF	1.340
10	.690	.900	.678	.6250-28 UN	1.340
14	.940	1.150	.928	.8750-28 UN	1.340
16	1.066	1.280	1.054	1.0000-28 UN	1.340
18	1.190	1.400	1.178	1.1250-28 UN	1.340

All dimensions for reference only.
All dimensions in inches and shown as Max. unless otherwise indicated.
* To complete order number see pages 14 and 15.

348 Series - accessories

cable clamp, dummy receptacle

cable clamp

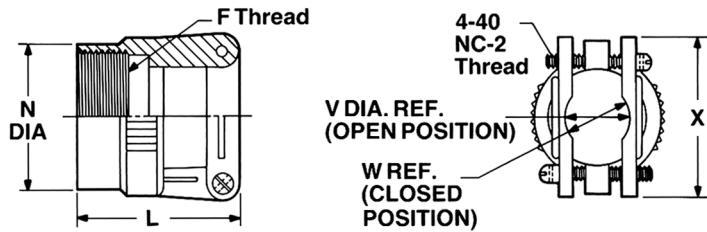

Used to support cable or wire at the connector and prevent twisting, pulling and strain on the wire terminations. Dimensions are the same for Series I and Series II.

Shell Size	Amphenol Part Number	MS Part Number	F Thread Class 2B	L Max.	N Dia. Max.	V Dia. Ref.	W Ref.	X Max.
8	348-260-08001	M81511/13-08XX*	.5000-28 UNEF	1.375	.558	.125	.062	.775
10	348-260-10001	M81511/13-10XX*	.6250-28 UN	1.375	.683	.250	.125	.955
14	348-260-14001	M81511/13-14XX*	.8750-28 UN	1.375	.933	.500	.250	1.145
16	348-260-16001	M81511/13-16XX*	1.0000-28 UN	1.375	1.059	.625	.375	1.210
18	348-260-18001	M81511/13-18XX*	1.1250-28 UN	1.375	1.183	.750	.500	1.330
20	348-260-20001	M81511/13-20XX*	1.2500-28 UN	1.452	1.308	.875	.625	1.470
22	348-260-22001	M81511/13-22XX*	1.3750-28 UN	1.452	1.433	1.000	.750	1.580
24	348-260-24001	M81511/13-24XX*	1.5000-28 UN	1.452	1.558	1.125	.750	1.720

* To complete MS Part Number add suffix A1 which designates Service Class E, H and P. Consult Amphenol, Sidney, NY for availability.

dummy receptacle

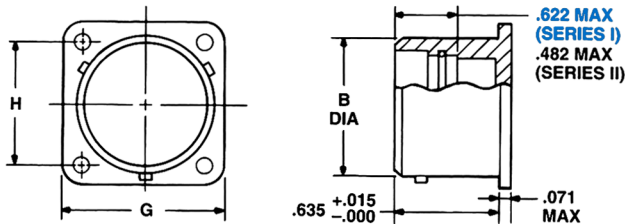

Used to anchor disconnected plugs and prevent damage or accumulation of dirt on face of plugs.

Use with Series I, Long

Shell Size	Amphenol Part Number	B Dia. Max.	G Max.	H ±.005
8	348-292-08000-01	.553	.819	.594
10	348-292-10000-01	.678	.944	.719
14	348-292-14000-01	.928	1.132	.906
16	348-292-16000-01	1.054	1.257	.969
18	348-292-18000-01	1.178	1.350	1.062
20	348-292-20000-01	1.303	1.474	1.156
22	348-292-22000-01	1.428	1.569	1.250
24	348-292-24000-01	1.553	1.709	1.375

Use with Series II, Standard

Shell Size	Amphenol Part Number	B Dia. Max.	G Max.	H ±.005
8	348-167-08000-01	.553	.819	.594
10	348-167-10000-01	.678	.944	.719
14	348-167-14000-01	.928	1.132	.906
16	348-167-16000-01	1.054	1.257	.969
18	348-167-18000-01	1.178	1.350	1.062

All dimensions for reference only.
All dimensions in inches and shown as Max. unless otherwise indicated.

348 Series - accessories

protection caps

receptacle protection cap

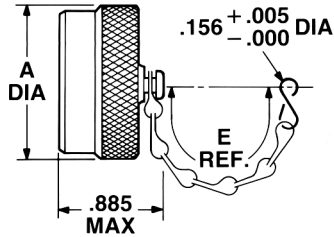

Dimensions and part numbers are the same for Series I and Series II.

Shell Size	Amphenol Part Number	MS Part Number	A Dia. Max.	E Ref.
8	348-140-08001	M81511/18-08	.844	3.000
10	348-140-10001	M81511/18-10	.969	3.000
14	348-140-14001	M81511/18-14	1.219	3.500
16	348-140-16001	M81511/18-16	1.345	3.500
18	348-140-18001	M81511/18-18	1.469	3.500
20	348-140-20001	M81511/18-20	1.594	3.500
22	348-140-22001	M81511/18-22	1.719	3.500
24	348-140-24001	M81511/18-24	1.844	3.500

plug protection cap

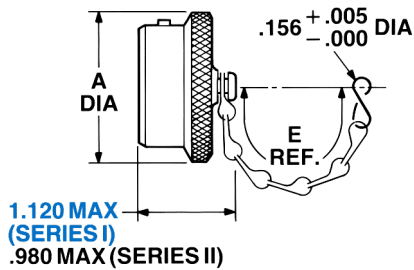

Use with Series I, Long

Shell Size	Amphenol Part Number	A Dia. Max.	E Ref.
8	348-289-08001	.844	3.000
10	348-289-10001	.969	3.000
14	348-289-14001	1.219	3.500
16	348-289-16001	1.345	3.500
18	348-289-18001	1.469	3.500
20	348-289-20001	1.594	3.500
22	348-289-22001	1.719	3.500
24	348-289-24001	1.844	3.500

Use with Series II, Standard

Shell Size	Amphenol Part Number	A Dia. Max.	E Ref.
8	348-139-08001	.844	3.000
10	348-139-10001	.969	3.000
14	348-139-14001	1.219	3.500
16	348-139-16001	1.345	3.500
18	348-139-18001	1.469	3.500

All dimensions for reference only.

All dimensions in inches and shown as Max. unless otherwise indicated.

348 Series

contacts, power and shielded

power contacts

Pin Contact, Use with Series I & II

Contact Size	Amphenol Part Number	Supersedes Amphenol Part Number	Military Part Number	Supersedes Military Part Number
23-28	10-807018-735	348-100-5047P-02	M39029/47-312	MS90461A23-28
23-22	10-807000-735	348-100-2202P-02	M39029/47-314	MS90461A23-22
20	10-807000-205	348-100-2000P-02	M39029/47-316	MS90461A20-20
16	10-807000-165	348-100-1600P-02	M39029/47-337	MS90461A16-16
12	10-807000-125	348-100-1200P-02	M39029/47-339	MS90461A12-12

Contact Size	Wire Size No. Accommodations	Current Rating (Amps)
23-28	28, 30, 32	1.5
23-22	22, 24, 26	5.0
20	20, 22, 24	7.5
16	16, 18, 20	13.0
12	12, 14	23.0

Socket Contact, Use with Series I

Contact Size	Amphenol Part Number	Supersedes Amphenol Part Number	Military Part Number	Supersedes Military Part Number
23-28	10-807403-735	348-100-5048S-02	M39029/33-262	MS3343A23-28
23-22	10-807401-735	348-100-2203S-02	M39029/33-264	MS3343A23-22
20	10-807401-205	348-100-2003S-02	M39029/33-266	MS3343A20-20
16	10-807003-165	348-100-1603S-02	M39029/33-268	MS3343A16-16
12	10-807003-125	348-100-1203S-02	M39029/33-270	MS3343A12-12

For insert arrangements that accept size 23 contacts, unless otherwise specified, the standard 23-22 contact will be supplied.

Socket Contact, Use with Series II

Contact Size	Amphenol Part Number	Supersedes Amphenol Part Number	Military Part Number	Supersedes Military Part Number
23-28	10-807402-735	348-100-5047S-02	M39029/46-302	MS90460A23-28
23-22	10-807400-735	348-100-2201S-02	M39029/46-304	MS90460A23-22
20	10-807400-205	348-100-2000S-02	M39029/46-306	MS90460A20-20
16	10-807001-165	348-100-1600S-02	M39029/46-308	MS90460A16-16
12	10-807001-125	348-100-1200S-02	M39029/46-310	MS90460A12-12

shielded contacts

Contact Size	Cable Accommodations*	Series I Amphenol Part Number**		Series II Amphenol Part Number**	
		Socket	Pin	Socket	Pin
16	RG-178A/U RG-196A/U	348-100-6011S-02	348-100-6010P-02	348-100-6010S-02	348-100-6010P-02
16	Revere WH-95623	348-100-6015S-02	348-100-6014P-02	348-100-6014S-02	348-100-6014P-02
12	RG-187A/U RG-188A/U RG-179B/U	348-100-6005S-02	348-100-6000P-02	348-100-6000S-02	348-100-6000P-02
12	Raychem 48-950	348-100-6006S-02	348-100-6001P-02	348-100-6001S-02	348-100-6001P-02
12	RG-180B/U RG-195A/U Micro Dot 293-3922	348-100-6007S-02	348-100-6002P-02	348-100-6002S-02	348-100-6002P-02
12	Micro Dot 250-4070	348-100-6008S-02	348-100-6003P-02	348-100-6003S-02	348-100-6003P-02
12	Raychem 48-502	348-100-6009S-02	348-100-6004P-02	348-100-6004S-02	348-100-6004P-02
12	Revere WH-95623	348-100-6012S-02	348-100-6012P-02	348-100-6013S-02	348-100-6012P-02

* Cables shown are typical. Consult Amphenol, Sidney NY if your cable is not listed.

** Available only under Amphenol part number.

348 Series

contact sealing plugs, application tools

contact sealing plugs

Used with both Series I, Long and Series II, Standard connectors.
Teflon sealing plugs assure proper connector sealing whenever all contacts are not employed.

Contact Size	Part Number	Color Code
23*	MS27488-22	White
20	MS27488-20	Red
16	MS27488-16	Blue
12	MS27488-12	Yellow

* Applies to both 23-28 and 23-22 contact sizes.

application tools

The following data includes information pertaining to the application tools which have been established for crimping, inserting and removing the size 12, 16, 20, 23-28 and 23-22 contacts incorporated in the 348 Series and MIL-C-81511 connectors as applicable. All crimping tools included are the "full cycling" type and when used as specified in the installation instructions L-2056 covering 348 Series connectors, will provide reliable crimped wire to contact terminations. Consult Amphenol, Sidney, NY for information on semi-automatic crimping equipment for large production runs.

Crimping Tools

Contact Size	Military Part Number	Supersedes Military Part Number
23*	M22520/2-01	MS3198-1
20	M22520/1-01	MS3191-4
16	M22520/1-01	MS3191-4
12	M22520/1-01	MS3191-4

* Applies to both 23-28 and 23-22 contact sizes.

Locator or Turret Head Assembly**

Contact Size	Military Part Number
23*	M22520/2-03
20	M22520/1-08
16	M22520/1-08
12	M22520/1-08

** Must be ordered separately.

Insertion Tools

Contact Size	Military Pin and Socket Tool Part Number	Supersedes Military Pin and Socket Tool Part Number	Color
23*	M81969/2-01	MS3323-22	Green
20	M81969/2-02	MS3323-20	Red
16	M81969/2-03	MS3323-16	Blue
12	M81969/2-04	MS3323-12	Yellow

Removal Tools

Contact Size	Military Pin Tool Part Number	Supersedes Military Pin Tool Part Number	Military Socket Tool Part Number	Supersedes Military Socket Tool Part Number	Color (Both Pin & Socket Tools)
23*	M81969/3-05	MS3342-23	M81969/3-01	MS3344-23	Yellow
20	M81969/3-06	MS3342-20	M81969/3-02	MS3344-20	Red
16	M81969/3-07	MS3342-16	M81969/3-03	MS3344-16	Blue
12	M81969/3-08	MS3342-12	M81969/3-04	MS3344-12	Yellow

* Applies to both 23-28 and 23-22 contact sizes

NOTE: Shielded contacts utilize size 16 and 12 insertion and removal tools.

The above crimping tools are available from the approved tool manufacturers.

348 Series

how to order

Amphenol Part Number

Amphenol® 348 Series Connectors can be ordered by coded part number. Ordering procedure is illustrated by part number 348-30E18-85P1() as shown below:

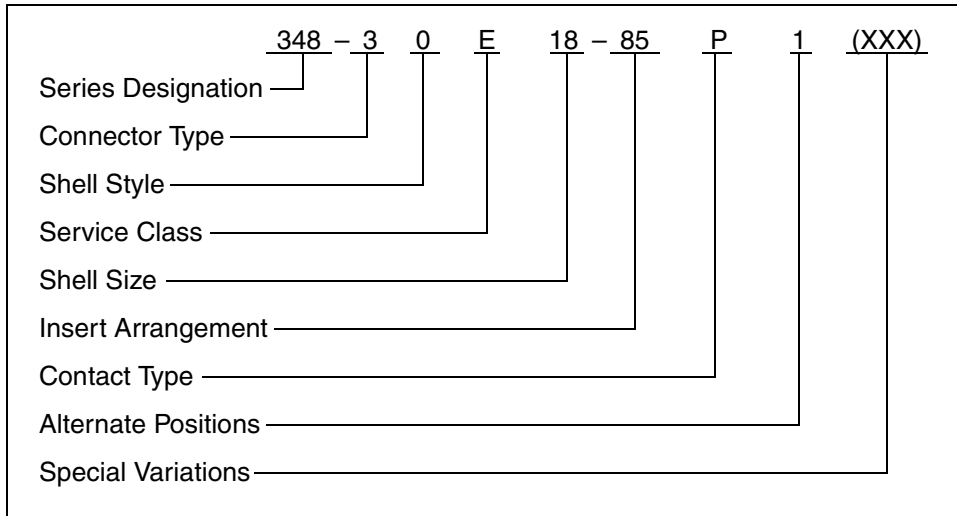

Series Designation

348 Series Connector

Connector Type

348-3 designates 348, Series I (Long) connector
 348-4 designates 348, Series II (Standard) connector

Shell Style

0 designates square flange receptacle
 1 designates cable receptacle
 3 designates single hole mounting receptacle
 6 designates straight plug

Service Class

E designates environmental
 W designates environmental, 500 hour salt spray

Shell Size

MIL-C-81511
 Series I (Long), sizes 8 – 24
 Series II (Standard), sizes 8 – 18

Insert Arrangement

MIL-C-81511, see insert arrangement chart, page 3

Contact Type

P designates pin contacts
 S designates socket contacts

Alternate Positions

Rotation of minor keys. See page 3.

Special Variations

(200) designates connector with cable clamp
 (201) designates connector less contacts
 (207) designates connector with fluorosilicone rubber seals and grommets

348 Series

how to order

Military Part Number

To more easily illustrate ordering procedure by military designation, part number M81511/01F01P1 is shown as follows:

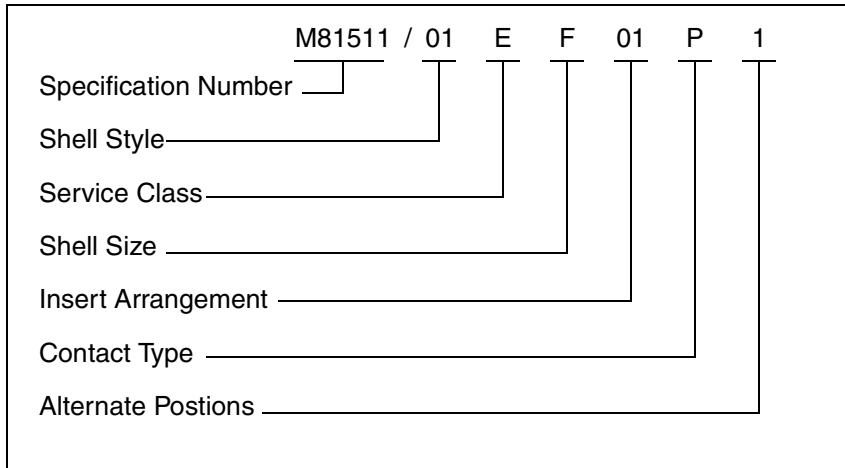

Specification Number

M81511 designates MIL-C-81511 Series Connector

Shell Style

Series I:

- /21 designates square flange receptacle
- /23 designates single hole mounting receptacle
- /25 designates cable receptacle
- /26 designates straight plug

Series II:

- /01 designates square flange receptacle
- /03 designates single hole mounting receptacle
- /05 designates cable receptacle
- /06 designates straight plug

Service Class

E designates grommet seal connectors (150°C operating temperature)

Shell Size

MIL-C-81511

Series I (Long), size 8 - 24

Series II (Standard), size 8 - 18

A	B	D	E	F	G	H	J	MIL Shell Size
8	10	14	16	18	20	22	24	Amphenol® Shell Size

Insert Arrangement

Code numbers coordinated with insert arrangement (see page 3). Example: F01 is 18-85 insert arrangement.

01	02	03	04	MS Letter Code
23-28	20	16	12	Contact Size
23-22				

Contact Type

P designates pin contacts
S designates socket contacts

Alternate Positions

Rotation of minor keys. See page 3.

Mouser Electronics

Authorized Distributor

Click to View Pricing, Inventory, Delivery & Lifecycle Information:

[Amphenol:](#)

[348-100-6001S-02](#) [MS3348-1-2L](#) [348-36E10-12P3](#) [348-100-1200P-2](#) [348-100-1200S-2](#) [348-100-11203S-2](#) [348-100-2000S-2](#) [348-260-16001](#) [348-36E16-27S1](#) [348-40E10-5P1](#) [348-46E10-5S1](#) [348-46E18-85S2](#) [348-46E18-85S1](#) [348-43E18-85S2](#) [348-36E18-38P4](#) [348-46E14-37S1](#) [348-260-14001](#) [348-260-18001](#) [348-260-20001](#) [348-36E14-9S1](#) [348-46E18-85S5](#) [348-36E16-27P1](#) [348-30E10-5P1](#) [348-36E10-12S1](#) [348-36E20-45P1](#) [348-46E14-37P4](#) [348-36E10-5S1](#) [348-46E18-85P1](#) [348-46E18-85P2](#) [348-36E18-85P1](#) [348-36E14-37P1](#) [348-36E18-85S2](#)