

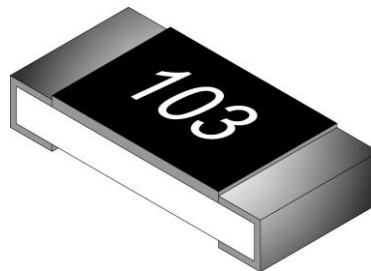

CRH Series Thick Film High Power Chip Resistor Product Specifications

Document No.	S-10-12-16-13
Released Date	2023/08/16
Page No.	1/13

Thick Film High Power Chip Resistor — CRH Series



Application

- Consumer electrical
- Home Appliance: Air conditioner, Refrigerator
- Computer & relative products: Main board
- Communication equipment: Cell phone, Fax machine
- Power equipment: Power supply , Illumination equipment
- Measuring instrument: Electric meter, Navigation equipment

Features

- Small size and light weight
- Reliability, high quality

Parts Number Explanation

Example:

CRH	0603	J	10R0	P	05	Z
Product Type	Size (Inch)	Resistor Tolerance	Resistor Value	Package	Quantity	Optional
CRH	0402 0603 0805 1206 1210 1812 2010 2512	B : ±0.1% D : ±0.5% F : ±1% G : ±2% J : ±5%	0R=0R00 10mR=R010 100mR=R100 1R=1R00 10R=10R0 100R=100R 1K=1K00 1M=1M00	P : Paper Taping (0603~1210) Q : Paper Taping (0402) E : Embossed Taping	04 : 4000PCS 05 : 5000PCS 10 : 10000PCS 40 : 40000PCS 50 : 50000PCS	Z : Default code S : Low TCR Alloy Film :100ppm



CRH Series Thick Film High Power Chip Resistor Product Specifications

Document No. S-10-12-16-13
 Released Date 2023/08/16
 Page No. 2/13

High Power Electrical Specifications

Item TYPE	Rated Power at 70°C	Max Working Voltage	Max Overload Voltage	T.C.R. (PPM/°C)	Resistance Range		
					B(±0.1%) D(±0.5%)	F(±1%) G(±2%)	J(±5%) K(±10%)
CRH0402	0.1W	50V	100V	±400	-	1Ω ≤ R < 10Ω	
				±100	10Ω ≤ R ≤ 1MΩ	10Ω ≤ R ≤ 10MΩ	
CRH0603	0.125W	75V	150V	±400	-	1Ω ≤ R < 10Ω	
				±100	10Ω ≤ R ≤ 1MΩ	10Ω ≤ R ≤ 10MΩ	
CRH0805	0.25 W	150V	300V	±400	-	1Ω ≤ R < 10Ω	
				±100	10Ω ≤ R ≤ 1MΩ	10Ω ≤ R ≤ 10MΩ	
CRH1206	0.5 W	200V	400V	±400	-	1Ω ≤ R < 10Ω	
				±100	10Ω ≤ R ≤ 1MΩ	10Ω ≤ R ≤ 10MΩ	
CRH1210	0.66W			±400	-	1Ω ≤ R < 10Ω	
				±100	10Ω ≤ R ≤ 1MΩ	10Ω ≤ R ≤ 10MΩ	
CRH1812	1 W			±400	-	1Ω ≤ R < 10Ω	
				±100	10Ω ≤ R ≤ 1MΩ	10Ω ≤ R ≤ 10MΩ	
CRH2010	1 W			±400	-	1Ω ≤ R < 10Ω	
				±100	10Ω ≤ R ≤ 1MΩ	10Ω ≤ R ≤ 10MΩ	
CRH2512	2 W			±400	-	1Ω ≤ R < 10Ω	
				±100	10Ω ≤ R ≤ 1MΩ	10Ω ≤ R ≤ 10MΩ	

- For non-standard parts, please contact our sales dept.
- Operating Temperature Range : -55°C ~ +155°C.
- Type CRH0603/0805/1206/1210/1812/2010/2512 1Ω ≤ R ≤ 10Ω optional code 「S」 is Low TCR Alloy Film :100ppm

Type	0402	0603	0805	1206	1210	1812	2010	2512
Jumper Resistance Value	20mΩ Max							
Jumper Rated Current	2A	2.5A	3.5A	5A	6A	7A	7A	10A
Max. Over Load Current <1 second and 1 times	6A	9A	13A	16A	19A	22A	22A	30A



CRH Series Thick Film High Power Chip Resistor Product Specifications

Document No.	S-10-12-16-13
Released Date	2023/08/16
Page No.	3/13

- High Power Low Ohm Chip Resistor
- High Power Electrical Specifications

Item TYPE	Rated Power at 70°C	Rated Voltage Range	Max Overload Voltage	T.C.R. (PPM/°C)	Resistance Range (mΩ)
					F(±1%)、J(±5%)
CRH0402	0.1W	0.15 ~ 0.32 V	0.79 V	±1000	220 ≤ R ≤ 450
				±800	450 < R < 1000
CRH0603	0.125W	0.10 ~ 0.35 V	0.88 V	±1000	75 ≤ R < 100
				±800	100 ≤ R ≤ 330
				±600	330 < R < 1000
CRH0805	0.25W	0.05 ~ 0.50 V	1.25 V	±1800	10 ≤ R < 50
				±800	50 ≤ R < 100
				±600	100 ≤ R < 1000
CRH1206	0.5W	0.07 ~ 0.71 V	1.77 V	±1800	10 ≤ R < 50
				±800	50 ≤ R < 100
				±600	100 ≤ R < 1000
CRH1210	0.66W	0.08 ~ 0.81 V	2.03 V	±1800	10 ≤ R < 50
				±800	50 ≤ R < 100
				±600	100 ≤ R < 1000
CRH1812	1W	0.10 ~ 1.00 V	2.50 V	±1800	10 ≤ R < 50
				±800	50 ≤ R < 100
				±600	100 ≤ R < 1000
CRH2010	1W	0.10 ~ 1.00 V	2.50 V	±1800	10 ≤ R < 50
				±800	50 ≤ R < 100
				±600	100 ≤ R < 1000
CRH2512	2W	0.14 ~ 1.41 V	3.54 V	±1800	10 ≤ R < 50
				±800	50 ≤ R < 100
				±600	100 ≤ R < 1000

- For non-standard parts, please contact our sales dept.
- Operating Temperature Range : -55°C ~ +155°C.



CRH Series Thick Film High Power Chip Resistor Product Specifications

Document No.	S-10-12-16-13
Released Date	2023/08/16
Page No.	4/13

- High Power High Ohm Chip Resistor
- High Power Electrical Specifications

Item TYPE	Rated Power at 70°C	Max Working Voltage	Max Overload Voltage	T.C.R. (PPM/°C)	Resistance Range	
					F(±1%)	J(±5%)
CRH0402	0.1W	50V	100V	±200	10.1 MΩ	10.1 MΩ
CRH0603	0.125 W	75V	150V			
CRH0805	0.25 W	150V	300V			
CRH1206	0.5 W	200V	400V		~	~
CRH1210	0.66 W					
CRH2010	1 W					
CRH2512	2 W				30 MΩ	30 MΩ

- For non-standard parts, please contact our sales dept.
- Operating Temperature Range : -55°C ~ +155°C.

■ **Type Dimension**

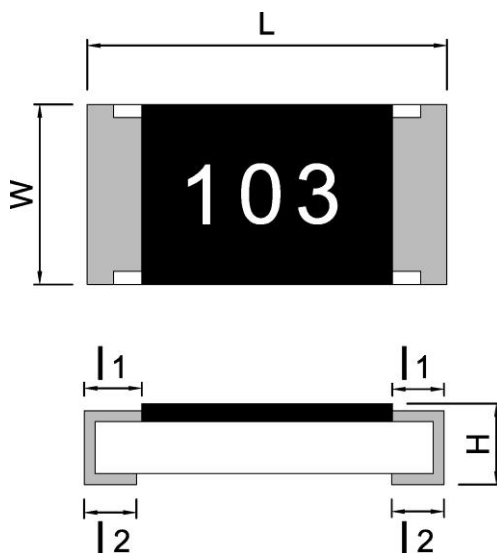

CRH0402 / CRH0603 / CRH0805 / CRH1206
CRH1210 / CRH1812 / CRH2010 / CRH2512

TYPE	L	W	H	l ₁	l ₂
CRH0402	1.00 ± 0.05	0.50 ± 0.05	0.30 ± 0.05	0.15 ± 0.10	0.20 ± 0.10
CRH0603	1.60 ± 0.1	0.80 ± 0.1	0.40 ± 0.10	0.30 ± 0.20	0.30 ± 0.10
CRH0805	2.00 ± 0.1	1.25 ± 0.1	0.50 ± 0.15	0.30 ± 0.15	0.40 ± 0.15
CRH1206	3.05 ± 0.10	1.60 ± 0.1	0.55 ± 0.15	0.40 ± 0.20	0.50 ± 0.20
CRH1210	3.05 ± 0.10	2.50 ± 0.15	0.55 ± 0.15	0.50 ± 0.20	0.50 ± 0.20
CRH1812	4.50 ± 0.10	3.10 ± 0.15	0.55 ± 0.05	0.55 ± 0.20	0.70 ± 0.20
CRH2010	5.00 ± 0.20	2.50 ± 0.15	0.55 ± 0.10	0.60 ± 0.20	0.60 ± 0.20
CRH2512	6.30 ± 0.20	3.20 ± 0.15	0.65 ± 0.10	0.60 ± 0.30	0.60 ± 0.30

● General Information

■ Recommend Land Pattern Design

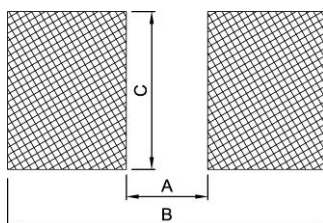

■ Dimension

Unit: mm

Item \ Type	0402	0603	0805	1206	1210	1812	2010	2512
A	0.60	0.80	1.30	2.20	2.00	3.11	3.80	4.90
B	1.60	2.40	2.90	4.20	4.40	5.91	6.60	8.10
C	0.70	1.00	1.40	1.70	2.70	3.00	2.70	3.40

■ Performance Characteristics

■ Power Derating Curve

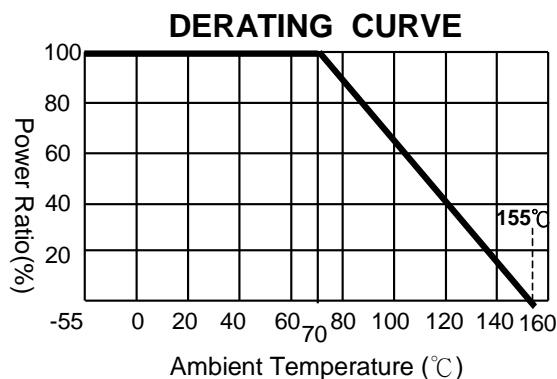

Power rating or current rating is in the case based on continuous full-load at ambient temperature of 70°C. For operation at ambient temperature in excess of 70°C, the load should be derated in accordance with figure of derating Curve.

■ Voltage Rating or Current Rating

Resistance Range: $\geq 1\Omega$

Rated Voltage: The resistor shall have a DC continuous working voltage or a RMS AC continuous working voltage at commercial-line frequency and wave form corresponding to the power rating, as determined formula as following:

$$E(RCWV) = \sqrt{P \times R}$$

E=Rated voltage(V)

P=Power rating(W)

R=Nominal resistance(Ω)



CRH Series Thick Film High Power Chip Resistor Product Specifications

Document No. S-10-12-16-13

Released Date 2023/08/16

Page No. 7/13

● Reliability Test and Requirement

Test Item	Test Method	Procedure	Requirements
Temperature Coefficient of Resistance (T.C.R)	JIS-C-5201-1 4.8 IEC-60115-1 4.8	At 25°C / -55°C and 25°C /+155°C, 25°C is the reference temperature	As Spec
Short Time Overload	JIS-C-5201-1 4.13 IEC-60115-1 4.13	High Power : 2.5 times RCWV or Max. Overload voltage whichever is less for 2 seconds. Jumper : Over Load Current for 5 seconds 0402=4.5A/0603=6.3A/0805=8.8A/1206=11A/ 1210=13A/1812=15A/2010=15A/2512=20A	1% and below : $\pm(1.0\%+0.05\Omega)$ 2%、5% : $\pm(2.0\%+0.10\Omega)$ Jumper : Max 0.02 Ω after test.
Leaching	JIS-C-5201-1 4.18 IEC-60068-2-58 8.2.1	260 \pm 5°C for 30 seconds.	Individual leaching area \leq 5% Total leaching area \leq 10%
Resistance to Soldering Heat	JIS-C-5201-1 4.18 IEC-60115-1 4.18	260 \pm 5°C for 10 seconds.	1% and below : $\pm(0.5\%+0.05\Omega)$ 2%、5% : $\pm(1.0\%+0.05\Omega)$
Rapid Change of Temperature	JIS-C-5201-1 4.19 IEC-60115-1 4.19	-55°C to +155°C,5 cycles	1% and below : $\pm(0.5\%+0.05\Omega)$ 2%、5% : $\pm(1.0\%+0.10\Omega)$
Resistance to Solvent	JIS-C-5201-1 4.29	The tested resistor be immersed into isopropyl alcohol of 20~25°C for 60 secs. Then the resistor is left in the room for 48 hrs.	1% and below : $\pm(0.5\%+0.05\Omega)$ 2%、5% : $\pm(0.5\%+0.05\Omega)$ Jumper : Max 0.02 Ω after test.
Damp Heat with Load	JIS-C-5201-1 4.24 IEC-60115-1 4.24	40 \pm 2°C, 90~95% R.H. RCWV or Max. working voltage whichever is less for 1000 hrs with 1.5 hrs "ON" and 0.5 hrs "OFF" .	1% and below : $\pm(1.0\%+0.05\Omega)$ 2%、5% : $\pm(2.0\%+0.05\Omega)$ Value <1 Ω : $\pm(2.0\%+0.05\Omega)$ Jumper : Max 0.05 Ω after test.
Load Life (Endurance)	JIS-C-5201-1 4.25 IEC-60115-1 4.25.1	70 \pm 2°C, RCWV or Max. working voltage whichever is less for 1000 hrs with 1.5 hrs "ON" and 0.5 hr "OFF" .	1% and below : $\pm(1.0\%+0.05\Omega)$ 2%、5% : $\pm(3.0\%+0.10\Omega)$ Value <1 Ω : $\pm(3.0\%+0.10\Omega)$ Jumper : Max 0.05 Ω after test.
Insulation Resistance	JIS-C-5201-1 4.6 IEC-60115-1 4.6	Apply 100VDC for 1 minute.	\geq 10G Ω
Bending Strength	JIS-C-5201-1 4.33 IEC-60115-1 4.33	Bending once for 5 seconds D : 0402、0603、0805=5mm 1206、1210、1812=3mm 2010、2512=2mm	1% and below : $\pm(1.0\%+0.05\Omega)$ 2%、5% : $\pm(1.0\%+0.05\Omega)$

■ **Recommended Customer Soldering Parameters**

■ **Wave solder Temperature condition**

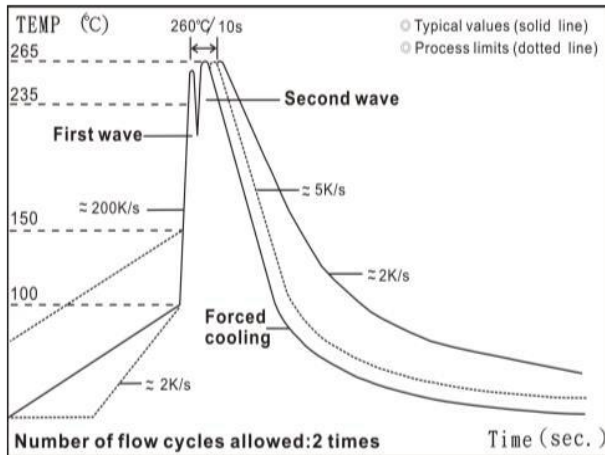

■ **Solder reflow Temperature condition**

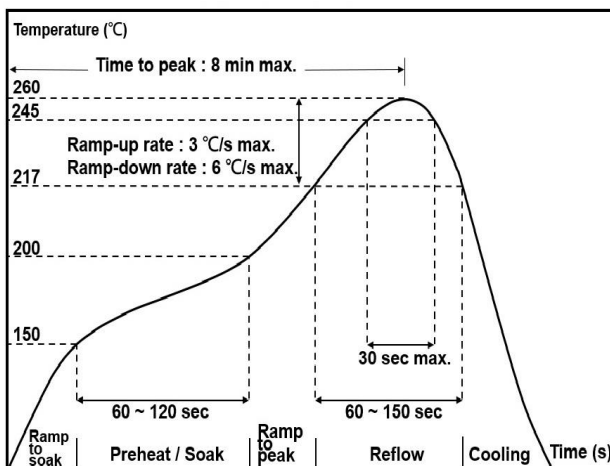

■ **Rework temperature (hot air equipment) : 350°C, 3~5seconds**

■ **Recommended reflow methods**

IR, vapor phase oven, hot air oven

If reflow temperatures exceed the recommended profile, devices may not meet the performance requirements.

■ **Appendix For SMD Chip Resistor**

● **Packaging Information**

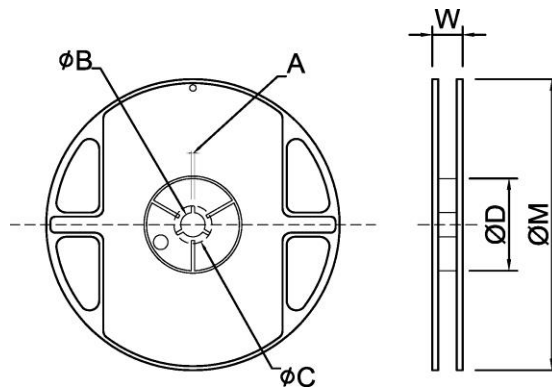

■ **Dimension**

Unit: mm

TYPE	SIZE		A	φB	φC	φD	W	φM
0402	7"	10K/Reel	2.0±0.5	13.5±1.0	21±1.0	60±1.0	11.5±2.0	178±2.0
	13"	40K/50K Reel	2.0±0.5	13.5±1.0	21±1.0	100±1.0	11.5±2.0	330±2.0
0603/0805/1206/1210	7"	5K/Reel	2.0±0.5	13.5±1.0	21±1.0	60±1.0	11.5±2.0	178±2.0
0603/0805 /1206	10"	10K/Reel	2.0±0.5	13.5±1.0	21±1.0	100±1.0	11.5±2.0	254±2.0
	13"	20K/Reel	2.0±0.5	13.5±1.0	21±1.0	100±1.0	11.5±2.0	330±2.0
2010/2512/1812	7"	4K/Reel	2.0±0.5	13.5±1.0	21±1.0	60±1.0	16.0±2.0	178±2.0

■ **Tapping Specification**

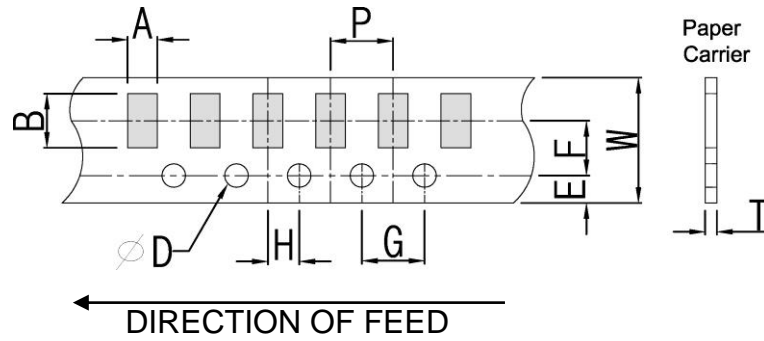

■ **Dimension**

Unit: mm

Packaging	Type	A	B	W	E	F	G	H	T	ΦD	P
Paper Type	0402	0.70±0.1	1.20±0.1	8.0±0.2	1.75±0.1	3.5±0.05	4.0±0.1	2.0±0.05	0.45±0.1	1.50 ^{+0.10} ₋₀	2.0±0.1
	0603	1.05±0.2	1.80±0.2	8.0±0.2	1.75±0.1	3.5±0.05	4.0±0.1	2.0±0.05	0.60±0.1		4.0±0.1
	0805	1.55±0.2	2.30±0.2	8.0±0.2	1.75±0.1	3.5±0.05	4.0±0.1	2.0±0.05	0.75±0.1		4.0±0.1
	1206	1.90±0.2	3.50±0.2	8.0±0.2	1.75±0.1	3.5±0.05	4.0±0.1	2.0±0.05	0.75±0.1		4.0±0.1
	1210	2.85±0.2	3.50±0.2	8.0±0.2	1.75±0.1	3.5±0.05	4.0±0.1	2.0±0.05	0.75±0.1		4.0±0.1

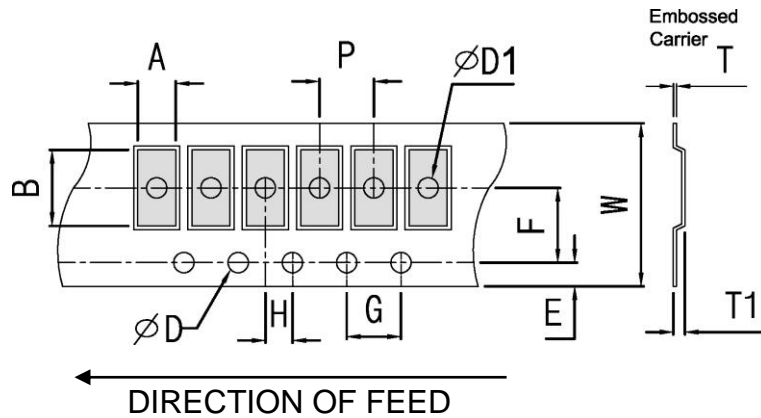

■ **Dimension**

Unit: mm

Packaging	Type	A	B	W	E	F	G	H	T	ΦD	ΦD1	T1	P
Embossed Type	2010	2.80±0.20	5.60±0.20	12±0.10	1.75±0.10	5.5±0.05	4.0±0.10	2.0±0.05	0.23±0.10	1.50 ^{+0.10} ₋₀	1.50±0.10	0.85±0.15	4.0±0.1
	2512-0.5mm	3.40±0.20	6.70±0.20	12±0.10	1.75±0.10	5.5±0.05	4.0±0.10	2.0±0.05	0.23±0.10		1.50±0.10	0.85±0.15	
	2512-0.635mm	3.40±0.20	6.70±0.20	12±0.10	1.75±0.10	5.5±0.05	4.0±0.10	2.0±0.05	0.23±0.10		1.50±0.10	0.95±0.15	
	1812	3.30±0.20	4.60±0.20	12±0.10	1.75±0.10	5.5±0.05	4.0±0.10	2.0±0.05	0.23±0.10		1.50±0.10	0.85±0.15	



CRH Series Thick Film High Power Chip Resistor Product Specifications

Document No.	S-10-12-16-13
Released Date	2023/08/16
Page No.	11/13

■ Packing Material Data/Storage Data

■ Front & Back Lead Dimension

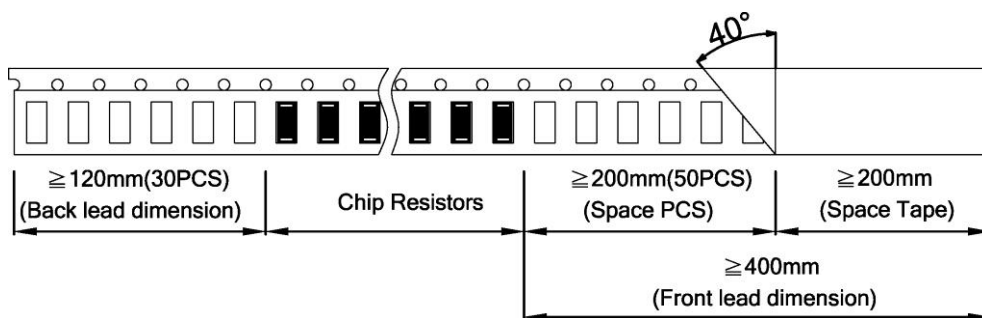

■ Top Adhesive Peel Off Strength : 10~70g

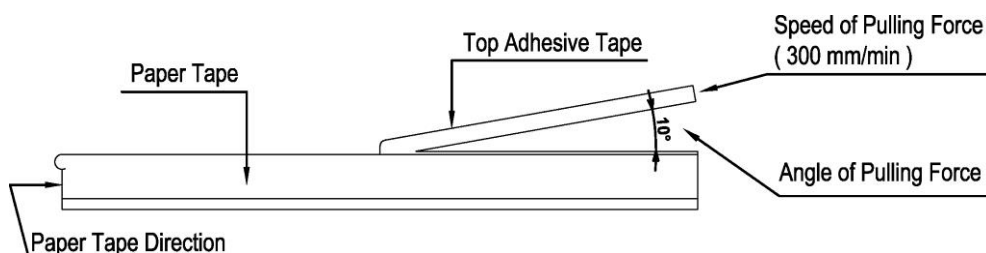

■ Package

Inner Box Size	
Reel	Size H(mm)
1	13
2	24
3	36
5	60
10	113

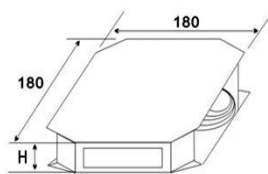

External Box Size			
Contain (Kpcs)	Length (mm)	Width (mm)	Height (mm)
25K	180	180	60
50K	180	180	110
150K	430	200	200
300K	400	400	200

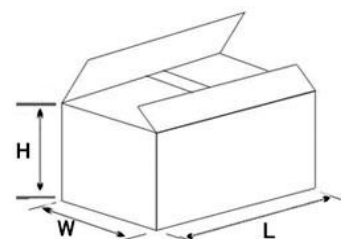

■ Storage Data :

Storage time at the environment temp: $25 \pm 5^\circ\text{C}$ & humidity: $60 \pm 20\%$ is valid for one year from the date of delivery.

■ Product Testing Method:

Our products are tested with our company's tapping & testing equipments by using four-feet probe to touch at the back of both electrodes. Supposed different testing points or methods are requested, please advise beforehand and customized-made production is available.



CRH Series Thick Film High Power Chip Resistor Product Specifications

Document No.	S-10-12-16-13
Released Date	2023/08/16
Page No.	13/13

mΩ Resistance Codes



0402: no marking



0603: 3 digits

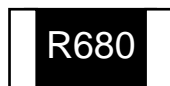

0805~2512: 4 digits

- 0402 : No marking
- 0603 : 3 digit marking

1. For E-24 values:

Resistance value	Code	Example
10mΩ ~ 99mΩ	0XX	068 = 68mΩ
100mΩ ~ 990mΩ	RXX	R68 = 680mΩ

E-24	10	11	12	13	15	16	18	20	22	24	27	30	33	36	39	43	47	51	56	62	68	75	82	91
------	----	----	----	----	----	----	----	----	----	----	----	----	----	----	----	----	----	----	----	----	----	----	----	----

2. For E-96 values: excluding values 10/11/13/15/20/75 of E-24 series.

- Standard E-96 Values and 0603 Resistance Codes

R-Value	100	102	105	107	110	113	115	118	121	124	127	130	133	137	140	143	147	150	154	158	162	165	169	174
Code	01	02	03	04	05	06	07	08	09	10	11	12	13	14	15	16	17	18	19	20	21	22	23	24
R-Value	178	182	187	191	196	200	205	210	215	221	226	232	237	243	249	255	261	267	274	280	287	294	301	309
Code	25	26	27	28	29	30	31	32	33	34	35	36	37	38	39	40	41	42	43	44	45	46	47	48
R-Value	316	324	332	340	348	357	365	374	383	392	402	412	422	432	442	453	464	475	487	499	511	523	536	549
Code	49	50	51	52	53	54	55	56	57	58	59	60	61	62	63	64	65	66	67	68	69	70	71	72
R-Value	562	576	590	604	619	634	649	665	681	698	715	732	750	768	787	806	825	845	866	887	909	931	953	976
Code	73	74	75	76	77	78	79	80	81	82	83	84	85	86	87	88	89	90	91	92	93	94	95	96

- E-96 Multiplier Code

Code	A	B	C	D	E	F	G	H	X	Y	Z
Multiplier	10 ⁰	10 ¹	10 ²	10 ³	10 ⁴	10 ⁵	10 ⁶	10 ⁷	10 ⁻¹	10 ⁻²	10 ⁻³

- 0603 3 digits coding formula for E-96 values as following:

CODING FORMULA

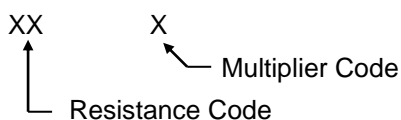

Example: $499 \text{ m}\Omega = \frac{499}{100} \times 10^{-3} \Omega = 68Z$

0805~2512 : 4 digit marking

1. For E-24 values:

Resistance value	Code	Example
10mΩ ~ 990mΩ	RXXX	R680 = 680mΩ

- Note: jumper zero ohm resistor marking code is one 「0」 (except type below 0402).