



Description

The FDS8949 uses advanced trench technology to provide excellent $R_{DS(ON)}$, low gate charge and operation with gate voltages as low as 2.5V. This device is suitable for use as a Battery protection or in other Switching application.

General Features

$V_{DS} = 40V$ $I_D = 12A$
 $R_{DS(ON)} < 16m\Omega$ @ $V_{GS}=10V$
 $R_{DS(ON)} < 24m\Omega$ @ $V_{GS}=4.5V$

Application

Battery protection
 Load switch
 Uninterruptible power supply

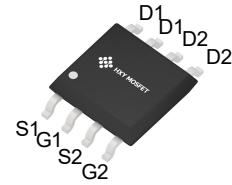

SOP-8
(SO-8-150mil)

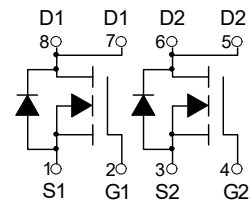

Dual N-Channel MOSFET

Ordering Information

Product ID	Pack	Brand	Qty(PCS)
FDS8949	SOP-8(SO-8-150mil)	HXY MOSFET	3000

Absolute Maximum Ratings@ $T_J=25^\circ C$ (unless otherwise specified)

Symbol	Parameter	Rating	Units
V_{DS}	Drain-Source Voltage	40	V
V_{GS}	Gate-Source Voltage	± 20	V
$I_D @ T_A=25^\circ C$	Drain Current, $V_{GS} @ 4.5V^3$	12	A
$I_D @ T_A=70^\circ C$	Drain Current, $V_{GS} @ 4.5V^3$	7	A
I_{DM}	Pulsed Drain Current ¹	40	A
$P_D @ T_A=25^\circ C$	Total Power Dissipation	2.9	W
T_{STG}	Storage Temperature Range	-55 to 150	$^\circ C$
T_J	Operating Junction Temperature Range	-55 to 150	$^\circ C$
R_{thj-a}	Maximum Thermal Resistance, Junction-ambient ³	65	$^\circ C/W$



Electrical Characteristics ($T_A=25^{\circ}\text{C}$ unless otherwise noted)

Parameter	Symbol	Condition	Min	Typ	Max	Unit
Off Characteristics						
Drain-Source Breakdown Voltage	BV_{DSS}	$V_{GS}=0V, I_D=250\mu A$	40	-	-	V
Zero Gate Voltage Drain Current	I_{DSS}	$V_{DS}=40V, V_{GS}=0V$	-	-	1	μA
Gate-Body Leakage Current	I_{GSS}	$V_{GS}=\pm 20V, V_{DS}=0V$	-	-	± 100	nA
On Characteristics (Note 3)						
Gate Threshold Voltage	$V_{GS(th)}$	$V_{DS}=V_{GS}, I_D=250\mu A$	1	1.5	2.0	V
Drain-Source On-State Resistance	$R_{DS(on)}$	$V_{GS}=10V, I_D=8A$	-	12.0	16	m Ω
		$V_{GS}=4.5V, I_D=4A$	-	18.9	24	m Ω
Forward Transconductance	g_{FS}	$V_{DS}=5V, I_D=8A$	33	-	-	S
Dynamic Characteristics (Note 4)						
Input Capacitance	C_{iss}	$V_{DS}=20V, V_{GS}=0V,$ $F=1.0\text{MHz}$	-	964	-	PF
Output Capacitance	C_{oss}		-	109	-	PF
Reverse Transfer Capacitance	C_{rss}		-	96	-	PF
Switching Characteristics (Note 4)						
Turn-on Delay Time	$t_{d(on)}$	$V_{DD}=20V, R_L=2.5\Omega$ $V_{GS}=10V, R_{GEN}=3\Omega$	-	5.5	-	nS
Turn-on Rise Time	t_r		-	14	-	nS
Turn-Off Delay Time	$t_{d(off)}$		-	24	-	nS
Turn-Off Fall Time	t_f		-	12	-	nS
Total Gate Charge	Q_g	$V_{DS}=20V, I_D=8A,$ $V_{GS}=10V$	-	22.9	-	nC
Gate-Source Charge	Q_{gs}		-	3.5	-	nC
Gate-Drain Charge	Q_{gd}		-	5.3	-	nC
Drain-Source Diode Characteristics						
Diode Forward Voltage (Note 3)	V_{SD}	$V_{GS}=0V, I_S=9A$	-	0.8	1.2	V



Typical Electrical and Thermal Characteristics (Curves)

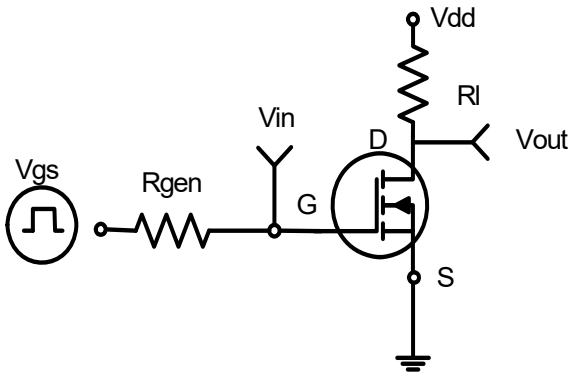

Figure 1: Switching Test Circuit

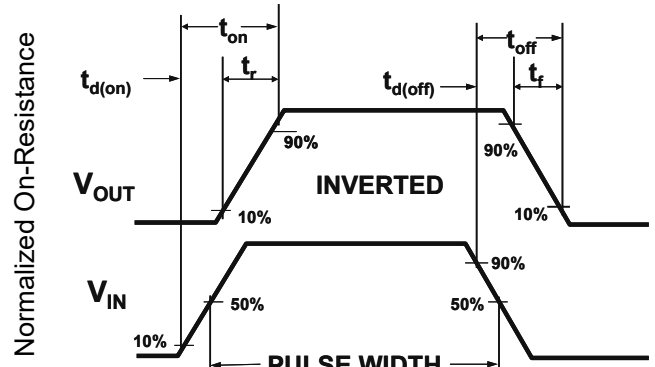

Figure 2: Switching Waveforms

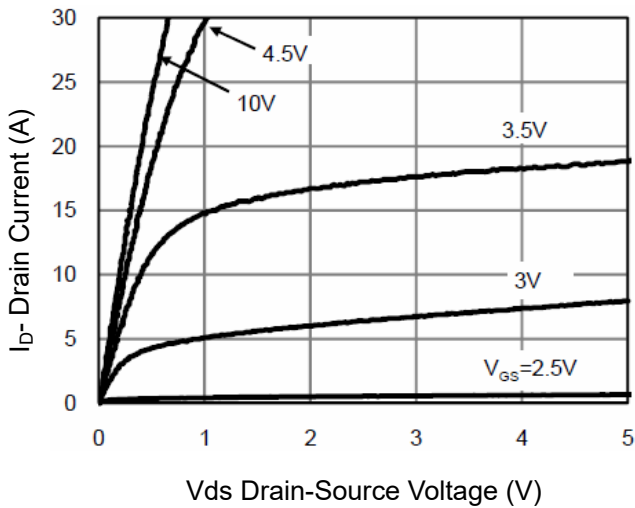

Figure 3 Output Characteristics

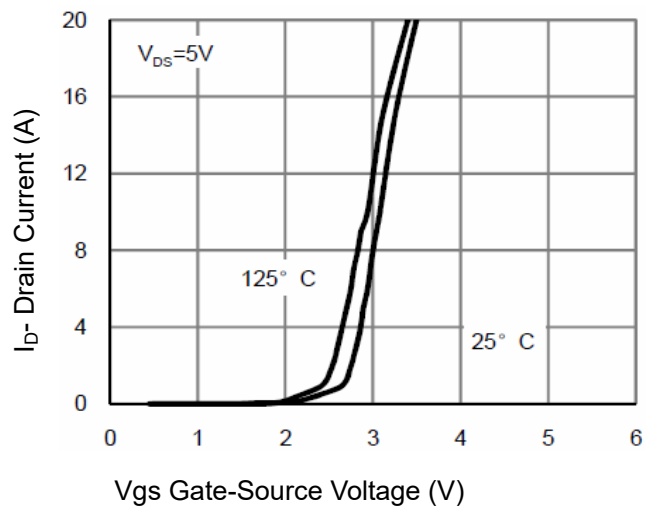

Figure 4 Transfer Characteristics

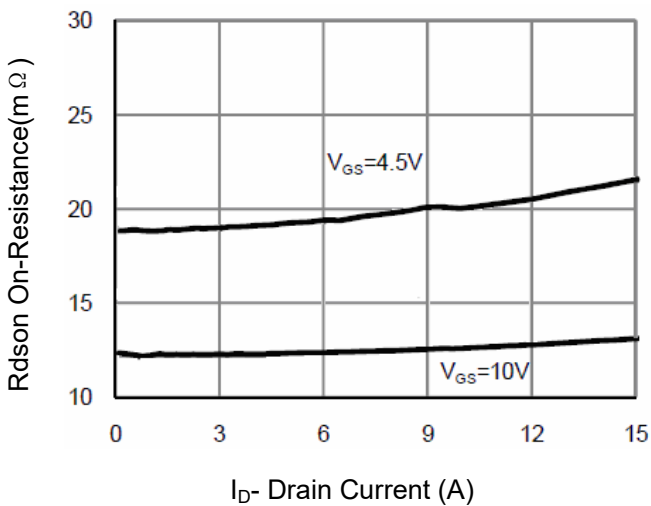

Figure 5 Drain-Source On-Resistance

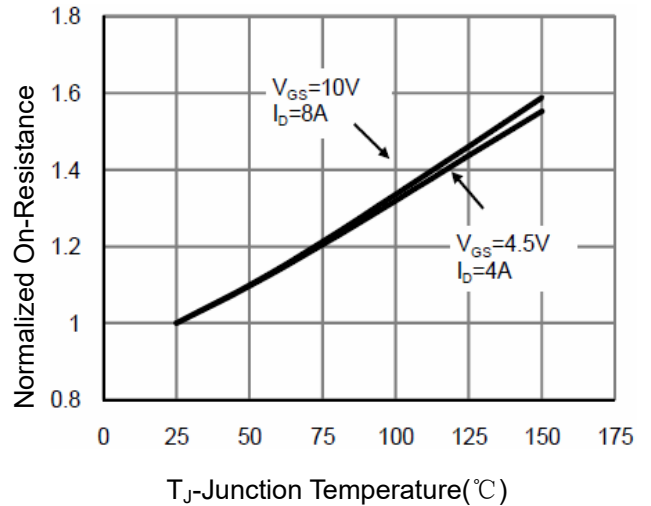
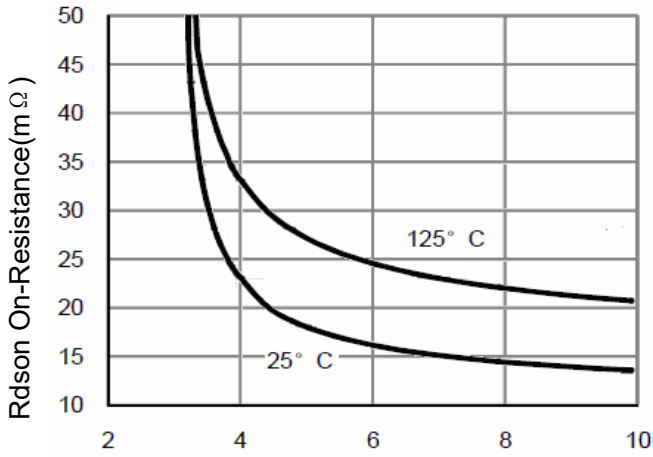
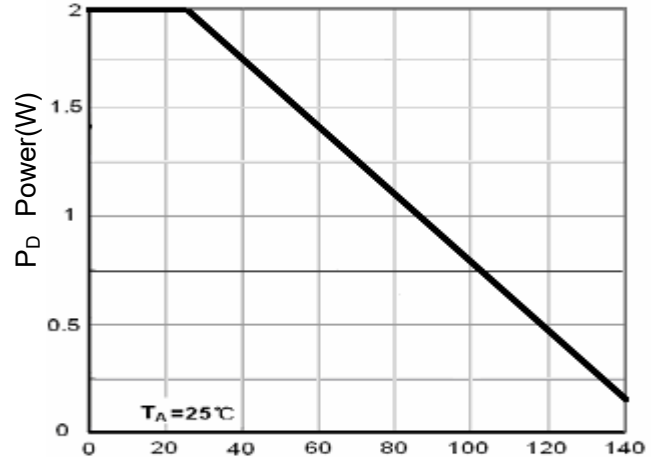

Figure 6 Drain-Source On-Resistance



Vgs Gate-Source Voltage (V)
Figure 7 Rdson vs Vgs



Tj-Junction Temperature (°C)
Figure 8 Power Dissipation

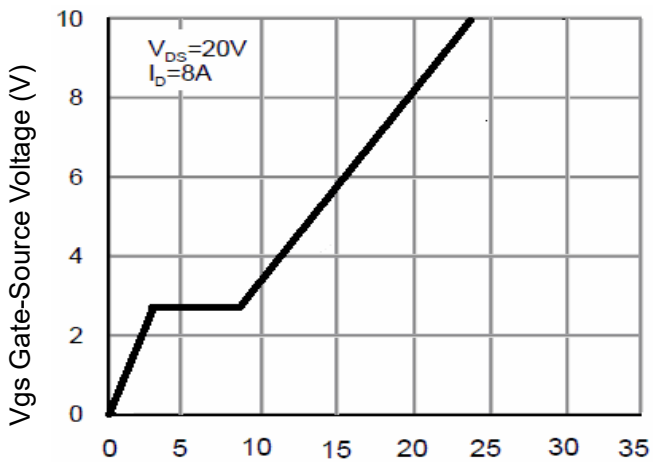

Vgs Gate-Source Voltage (V)
Figure 9 Gate Charge

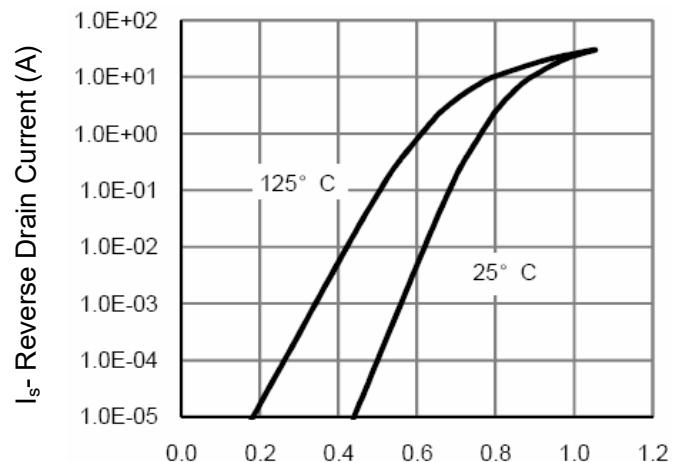

Vds Drain-Source Voltage (V)
Figure 10 Source-Drain Diode Forward

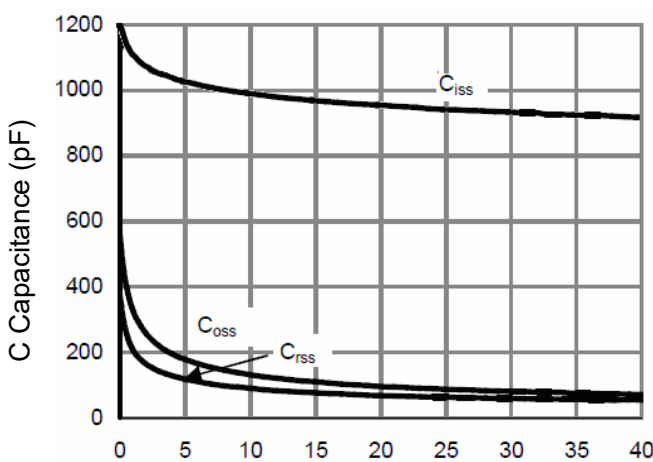

Vds Drain-Source Voltage (V)
Figure 11 Capacitance vs Vds

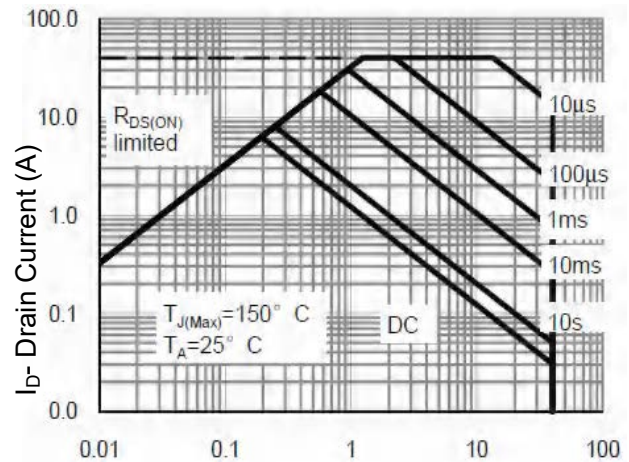

Vds Drain-Source Voltage (V)
Figure 12 Safe Operation Area



SOP-8(SO-8-150mil) Package Outline Dimensions

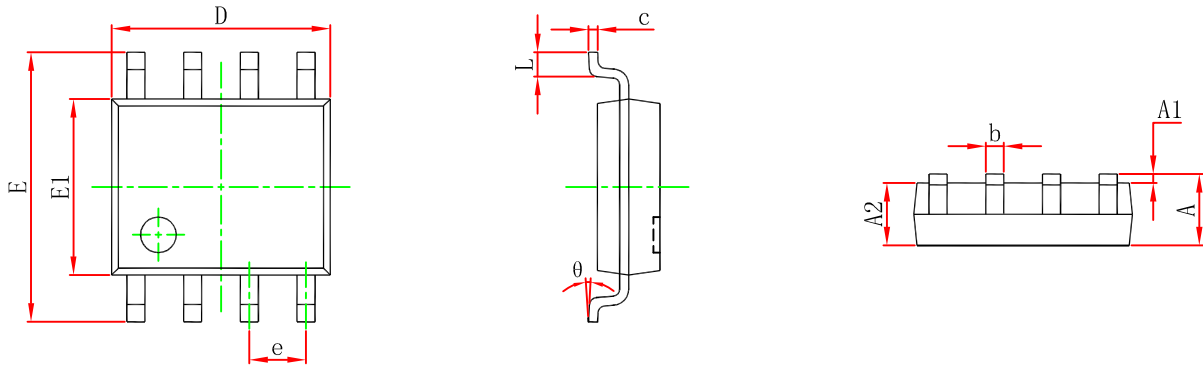

Symbol	Dimensions In Millimeters		Dimensions In Inches	
	Min	Max	Min	Max
A	1.350	1.750	0.053	0.069
A1	0.100	0.250	0.004	0.010
A2	1.350	1.550	0.053	0.061
b	0.330	0.510	0.013	0.020
c	0.170	0.250	0.007	0.010
D	4.800	5.000	0.189	0.197
e	1.270 (BSC)		0.050 (BSC)	
E	5.800	6.200	0.228	0.244
E1	3.800	4.000	0.150	0.157
L	0.400	1.270	0.016	0.050
θ	0°	8°	0°	8°

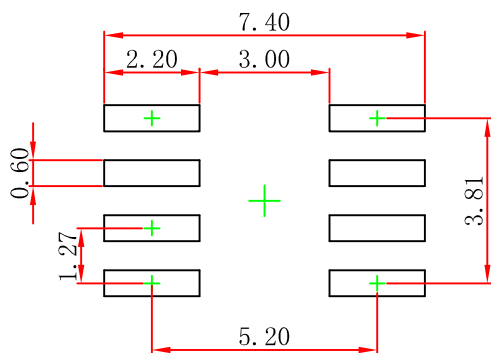

Note:
 1. Controlling dimension: in millimeters.
 2. General tolerance: $\pm 0.05\text{mm}$.
 3. The pad layout is for reference purposes only.



Attention

- Any and all HUA XUAN YANG ELECTRONICS products described or contained herein do not have specifications that can handle applications that require extremely high levels of reliability, such as life-support systems, aircraft's control systems, or other applications whose failure can be reasonably expected to result in serious physical and/or material damage. Consult with your HUA XUAN YANG ELECTRONICS representative nearest you before using any HUA XUAN YANG ELECTRONICS products described or contained herein in such applications.
- HUA XUAN YANG ELECTRONICS assumes no responsibility for equipment failures that result from using products at values that exceed, even momentarily, rated values (such as maximum ratings, operating condition ranges, or other parameters) listed in products specifications of any and all HUA XUAN YANG ELECTRONICS products described or contained herein.
- Specifications of any and all HUA XUAN YANG ELECTRONICS products described or contained herein stipulate the performance, characteristics, and functions of the described products in the independent state, and are not guarantees of the performance, characteristics, and functions of the described products as mounted in the customer's products or equipment. To verify symptoms and states that cannot be evaluated in an independent device, the customer should always evaluate and test devices mounted in the customer's products or equipment.
- HUA XUAN YANG ELECTRONICS CO.,LTD. strives to supply high-quality high-reliability products. However, any and all semiconductor products fail with some probability. It is possible that these probabilistic failures could give rise to accidents or events that could endanger human lives, that could give rise to smoke or fire, or that could cause damage to other property. When designing equipment, adopt safety measures so that these kinds of accidents or events cannot occur. Such measures include but are not limited to protective circuits and error prevention circuits for safe design, redundant design, and structural design.
- In the event that any or all HUA XUAN YANG ELECTRONICS products(including technical data, services) described or contained herein are controlled under any of applicable local export control laws and regulations, such products must not be exported without obtaining the export license from the authorities concerned in accordance with the above law.
- No part of this publication may be reproduced or transmitted in any form or by any means, electronic or mechanical, including photocopying and recording, or any information storage or retrieval system, or otherwise, without the prior written permission of HUA XUAN YANG ELECTRONICS CO.,LTD.
- Information (including circuit diagrams and circuit parameters) herein is for example only ; it is not guaranteed for volume production. HUA XUAN YANG ELECTRONICS believes information herein is accurate and reliable, but no guarantees are made or implied regarding its use or any infringements of intellectual property rights or other rights of third parties.