

ST213/产品基本参数

安倍:32A 电压:250V 线径:0.08-4mm²
 胶壳: 尼龙66工程塑料, UL 94V-0阻燃等级
 温度: 110° C (UL), -40° C to T110° C (IEC)
 触点材料: 紫铜, 镀镍
 弹片: 不锈钢(301)
 推荐剥线长度: 9-10mm
 接线位数: 3位 1进2出

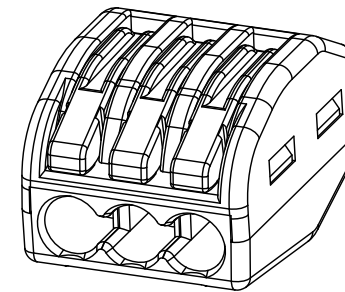
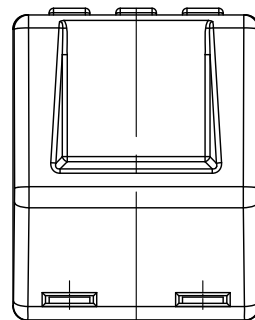
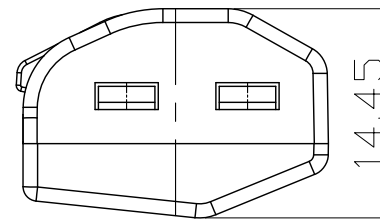
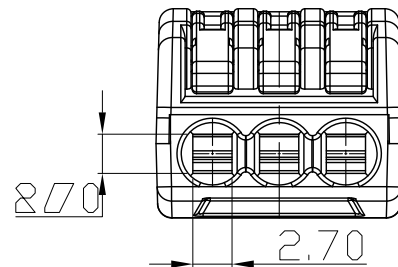
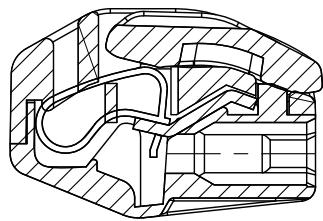
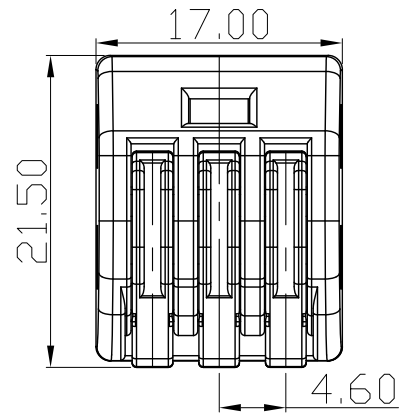

—		new		2015/5/3	A	瀚源	
ECN BO.		DESCRIPTION.		DATE.	REV.		
DESIGNED	CHECKED	APPROVAL	DRAWING NUMBER	SCALT: 1/2		SCALE: 3:1	
Mikey	Tom	Jerry	PART NAME	ST-213	UNLESS OTHERWISE SPECIFIED, TOLERANCE:	X.	±0.25
			MODEL NAME	ST-213		X.x	±0.20
			3RD ANGLE PROJ	HanElectricity Co.,LTD		X.xx	±0.15
						ANGULAR	±3°
						FILE.NO.	