

Smart motor driver with embedded Hall sensor

Features

- Motor driver with high sensitivity Hall-effect sensor
- H-Bridge MOS driver
- Lock-shutdown protection & auto-restart function
- Built-in tachometer signal output(FG, only for FD125Cf)
- Built-in alarm signal output(RD, only for FD125Mf)
- "Soft-switch" phase-switching technique to reduce vibration and acoustic noise
- Thermal shutdown protection(TSD)
- Available in TS825 package
- For 12V DC motor / FAN systems

Halogen Free

General Description

FD125Cf/FD125Mf is a single-phase full wave motor driver with embedded Hall-effect sensor IC. It integrates a H-bridge MOS driver, a high sensitivity hall-effect sensor, an event timer for rotor locked, tachometer or alarm output logic only in TS825 package, which make the motors' PCBs(printed circuit boards) design easy and fabricate the small and tiny size DC motors or FANs as simply as possible.

For safety, Lock-shutdown function would turn the IC's internal drivers off avoiding over-heat when the rotor is locked, and IC will try to re-start the rotor's torque after the time of these drivers' shutdown.

FD125xf is built-in the tachometer signal or alarm signal output function, the external system could be readout the motor's speed (FG) or rotation status (RD) from the signal pin of FD125xf IC.

Thermal-shutdown protection (TSD) ensures the internal drivers of IC are operating under a safe operating temperature range.

All the protection mechanisms mentioned above combine to provide a complete protecting scenario in the motor system and avoid any possible damages and guarantee under a correct and safe operation.

Block Diagram

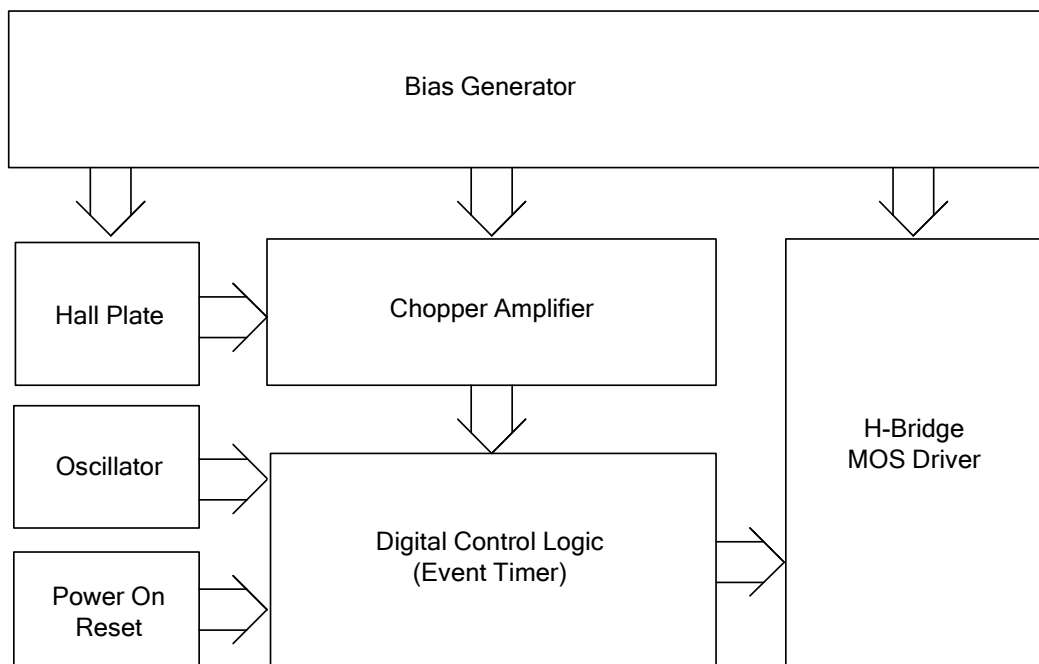
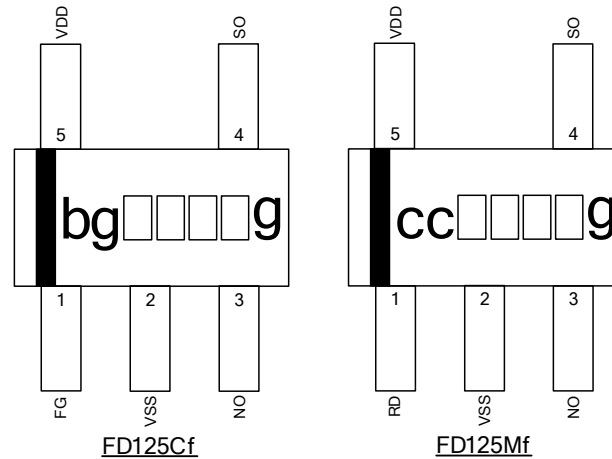

Figure.1

This datasheet contains new product information. Feeling Technology reserves the rights to modify the product specification without notice. No liability is assumed as a result of the use of this product. No rights under any patent accompany the sales of the product.

Pin Connection

Figure.2
Pin Descriptions

Name	I/O	FD125Cf	FD125Mf	Description
FG	O	1	-	Tachometer Signal Output
RD	O	-	1	Alarm Signal Output
VSS	G	2	2	Ground
NO	O	3	3	Driver Output 1
SO	O	4	4	Driver Output 2
VDD	P	5	5	Positive Power Supply

Legend: I=input, O=output, I/O=input/output, P=power supply, G=ground

Functional Descriptions

Refer to the block diagram (Figure.1), FD125Cf/FD125Mf is composed of the following building blocks:

- Bias generator

The bias generator provides precise, temperature- and process-insensitive bias references for the analog circuit blocks. These references guarantee proper operation of the IC under all conditions specified in this specification.

- Oscillator

The built-in oscillator provides the clock signal for the digital control logics

- Power-on Reset

Used to detect the power-up ramp and reset the digital circuits to achieve correct operation as soon as the power is ready.

- Chopper Amplifier

To achieve a higher magnetic sensitivity the chopper amplifier structure is adopted in this design. Use of this structure dynamically removes both the offset and flicker noise at the same time.

- Digital control logics

- Hall sensor part – generates controlling signals for the Hall sensor.
- Coil driver part – generates controlling signals for the Coil driver.
- Timer part – generates an interval of time when rotor locked event is occurred.
- Signal part – generates a tachometer (FG) or alarm (RD) signal output.

Absolute Maximum Ratings

Parameter	Symbol	Conditions	Values			Unit
			min.	typ.	max.	
Operating Temperature	T _{OP}	-	-20	-	85	°C
Storage Temperature	T _{ST}	-	-40	-	150	°C
DC Supply Voltage(V _{DD} , FG, RD)	V _{DD}	-	-	-	18	V
Supply Current	I _{DD}	-	-	-	6	mA
Continuous Current	I _{O(CONT)}	-	-	-	200	mA
Hold Current	I _{O(HOLD)}	-	-	-	400	mA
FG, RD Sink Current	I _{FG} I _{RD}	-	-	-	25	mA
Junction Temperature	T _J	-	-	-	170	°C
Maximum Power Dissipation	P _{DTS825}	-	-	-	500	mW
Thermal Resistance (note1)	θ _{ja}	TS825	-	0.29	-	°C/mW
Thermal Resistance (note1)	θ _{jc}	TS825	-	0.08	-	°C/mW
Magnetic Flux Density	B	-	-	-	Unlimited	Gauss
IR-Reflow Lead Temperature	T _P	10sec	-	-	260	°C

Note1: device mounted with copper area of approximately 30mm² 1oz, no air flow. (room temperature: 25 °C)

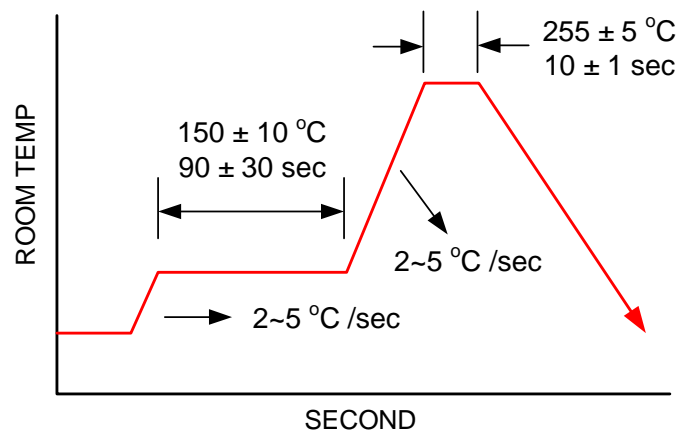

IR-ReFlow Soldering Condition

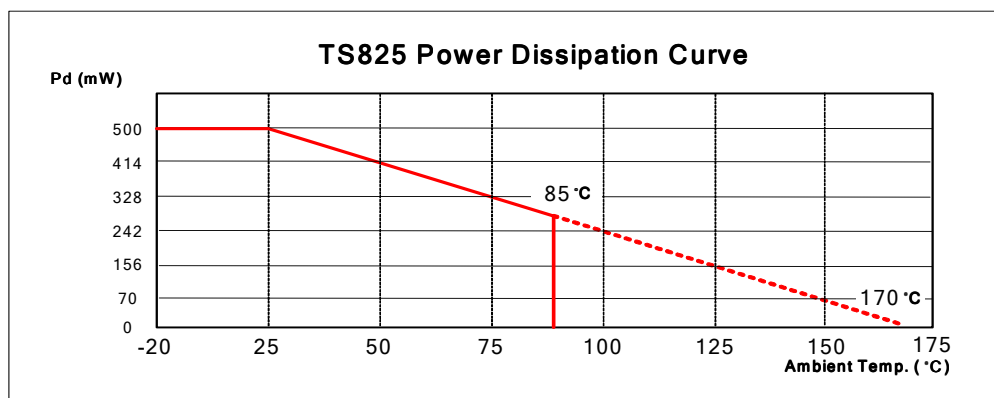

Recommended Operating Conditions

Parameter	Symbol	Conditions	Values			Unit
			min.	typ.	Max.	
Supply Voltage	V_{DD}	-	2.5	-	17	V
Operating Temperature Range	T_A	-	-20	-	85	°C

Electrical Characteristics $V_{DD}=12V, T_A=25^\circ C$ (unless otherwise specified)

Parameter	Symbol	Conditions	Values			Unit
			min.	typ.	Max.	
Average Supply Current(no load)	I_{DD}	-	-	3	-	mA
FG, RD Saturation Voltage	V_{FG}, V_{RD}	$I_{FG}, I_{RD} = 5mA$	-	-	0.4	V
FG, RD Leakage Current	$I_{LEAKAGE}$	$V_{FG}, V_{RD} = 5.0V$	-	-	1	μA
On Resistance ($R_{pmos}+R_{nmos}$)	$R_{DS(ON)}$	-	-	3	-	Ohm
Thermal Shutdown Threshold	T_{SHUT}	-	150	-	-	°C
Thermal Shutdown Hysteresis	T_{HYS}	-	-	30	-	°C
Locked Rotor Period	T_{ON}	-	-	0.4	-	s
Locked Rotor Period	T_{OFF}	-	-	4.0	-	s

Magnetic Characteristics

Parameter	Symbol	Conditions	Values			Unit
			min.	typ.	Max.	
Operate Points	B_{OP}	-	5	15	25	G
Release Points	B_{RP}	-	-25	-15	-5	G
Hysteresis	B_{HYS}	-	10	30	50	G

Driver output vs. Magnetic Pole

Parameter	Test Conditions	NO	SO
North pole	$B < B_{rp}$	High	Low
South pole	$B > B_{op}$	Low	High

Note: The magnetic pole is applied facing the branded side of the package

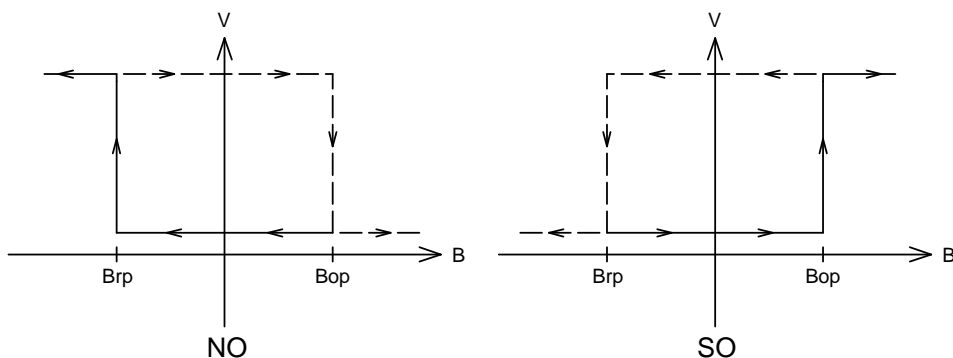
Hysteresis Characteristics

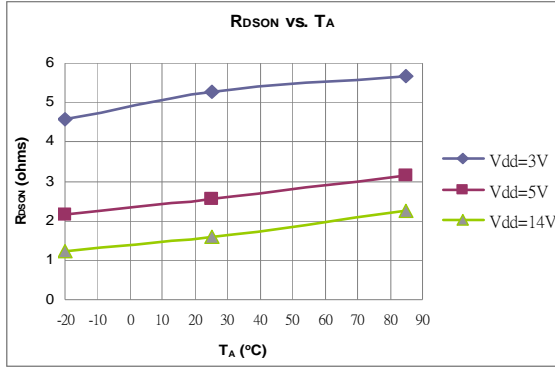
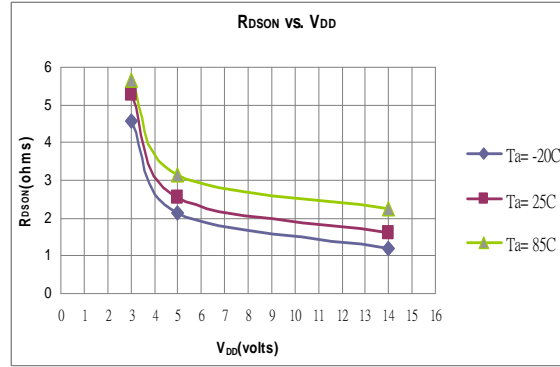
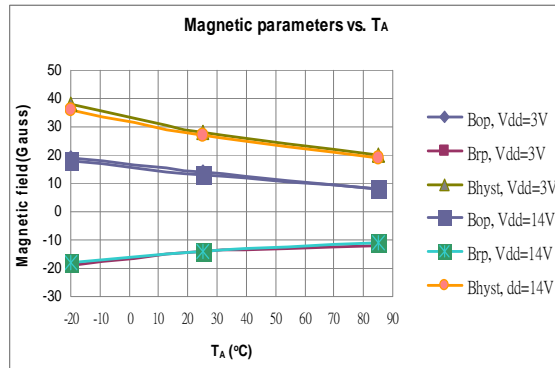
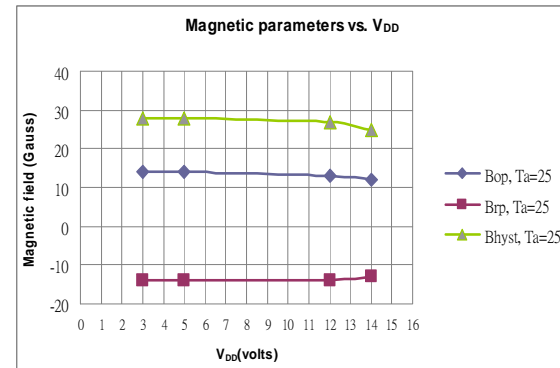
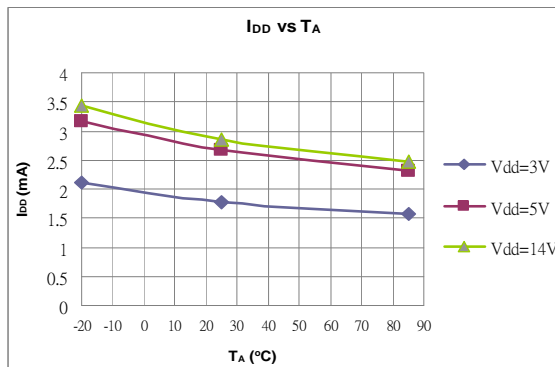
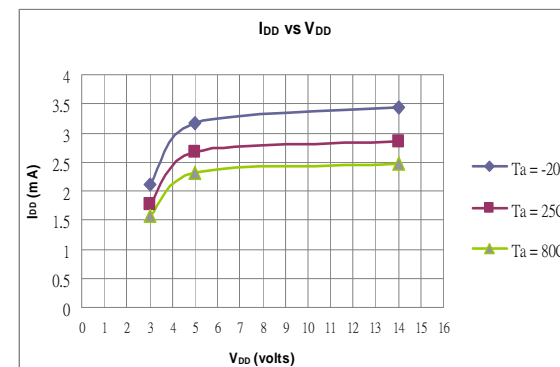
Performance Graphs

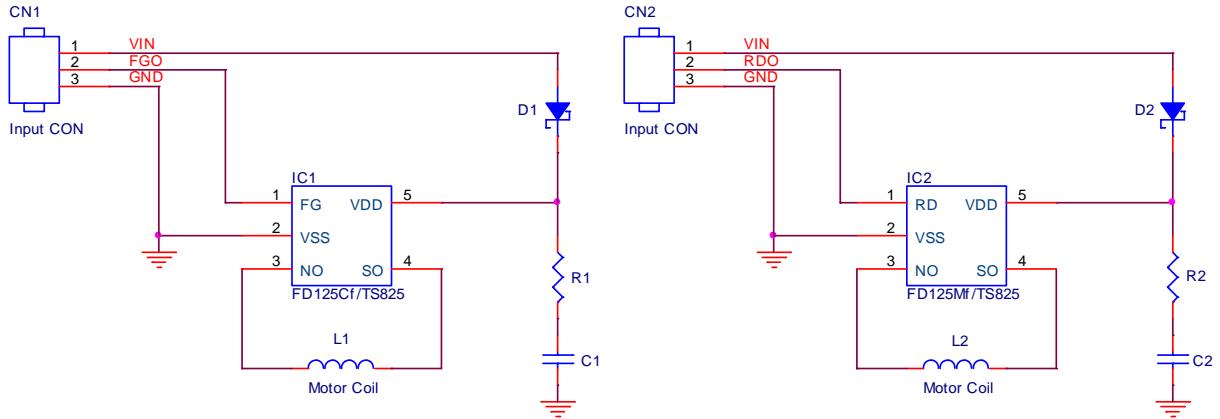
Figure.3

Figure.4

Figure.5

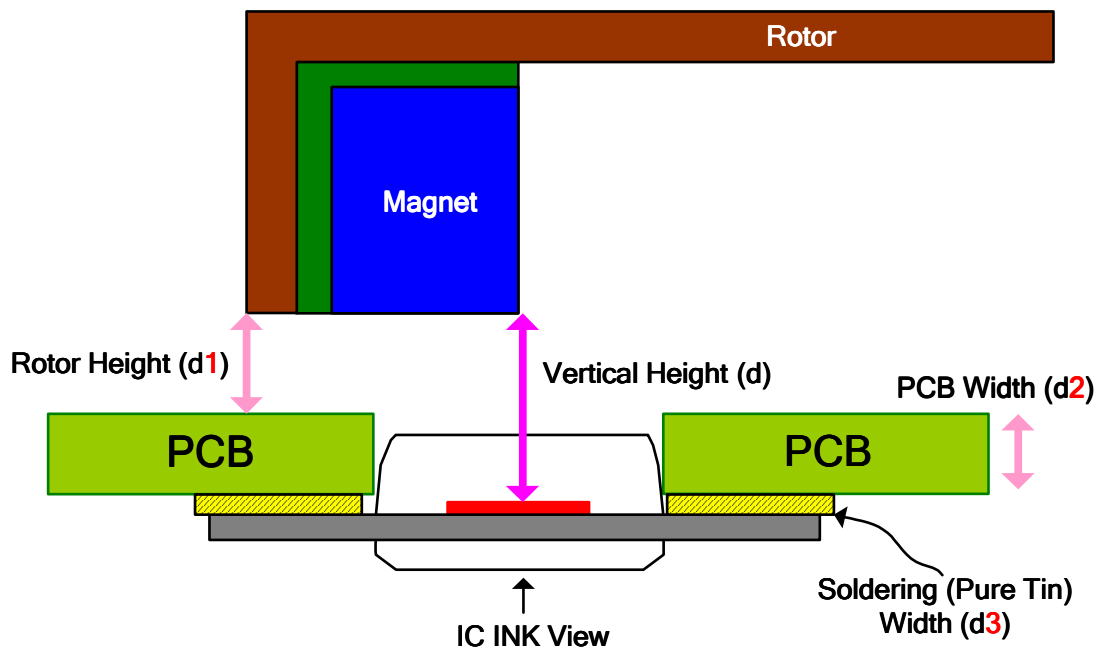
Figure.6

Figure.7

Figure.8

Application Circuit Reference

Figure.9 FD125Cf/FD125Mf Typical Application Circuits
Note:

Must use R1-C1(R2-C2) capacitor for the decoupling between V_{DD} and V_{SS} and place the capacitor as close to the IC as possible.

The IC laying aside mode declaration is as follows:

Figure.10



FD125Cf/FD125Mf Output Waveforms Description

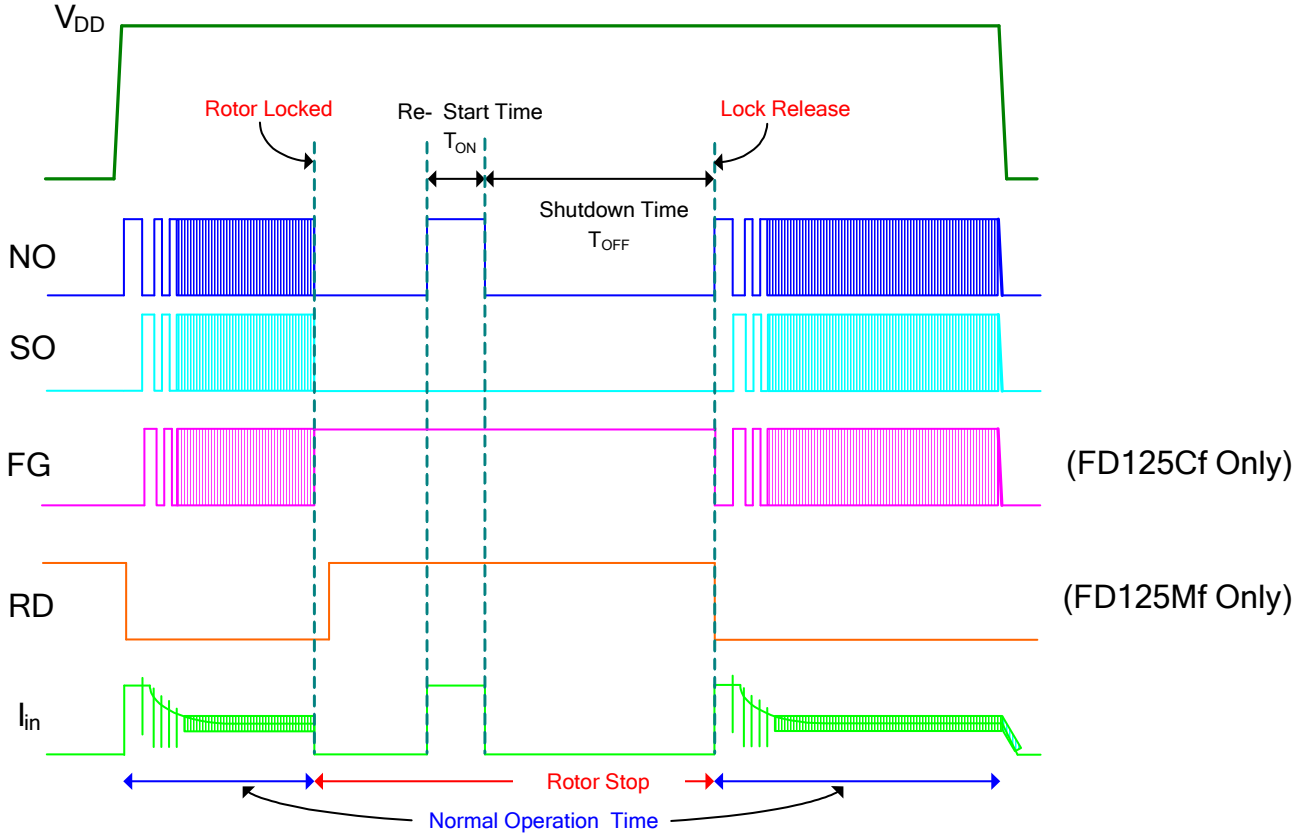

Figure.11



FD125Cf/FD125Mf Output Waveforms Measurement

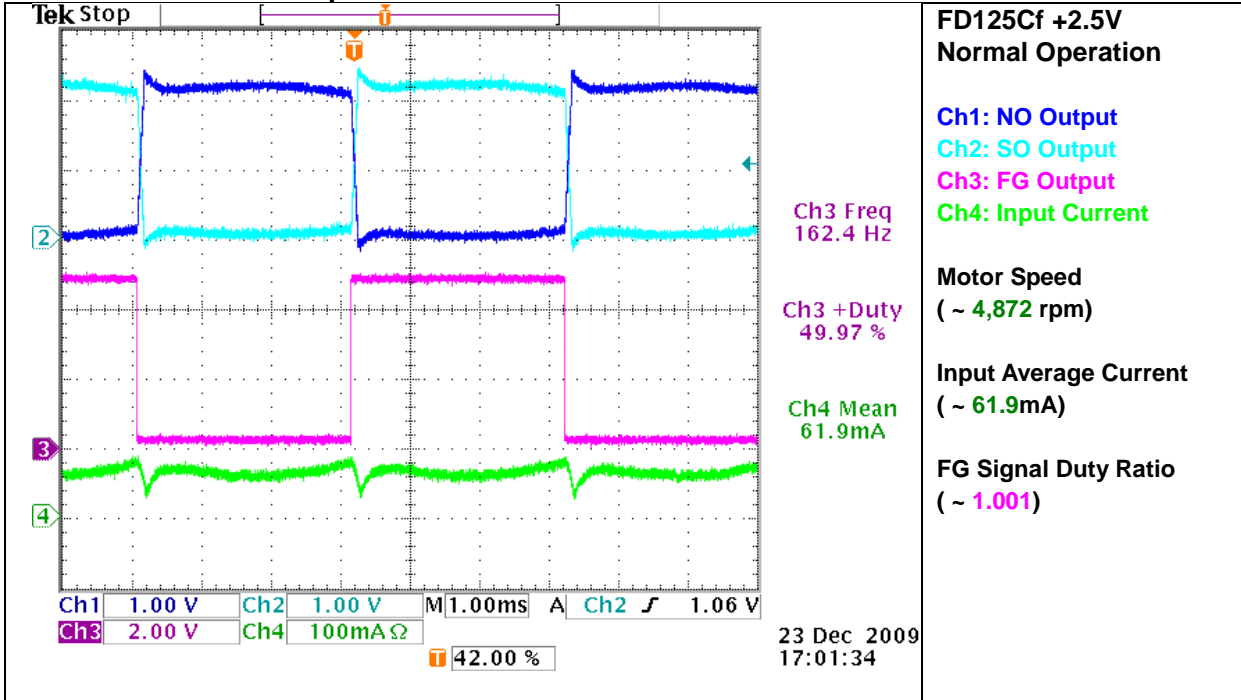

Figure.12

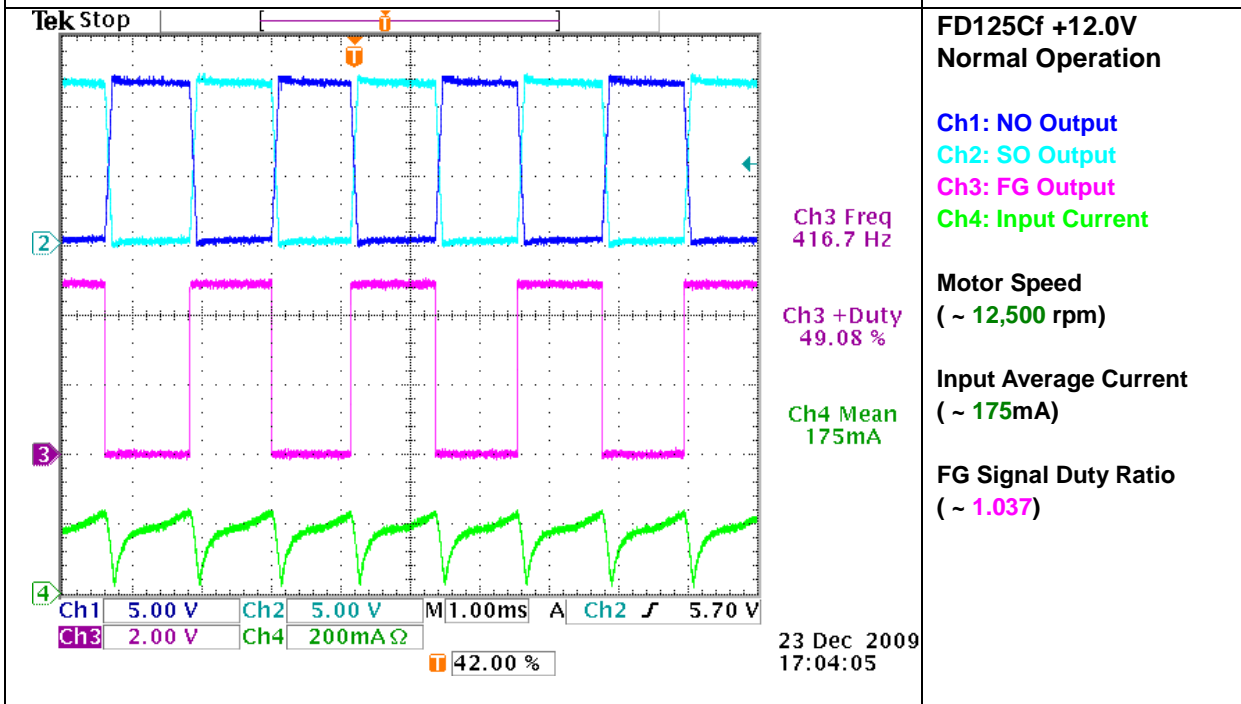

Figure.13



FD125Cf/FD125Mf Output Waveforms Measurement (Con't)

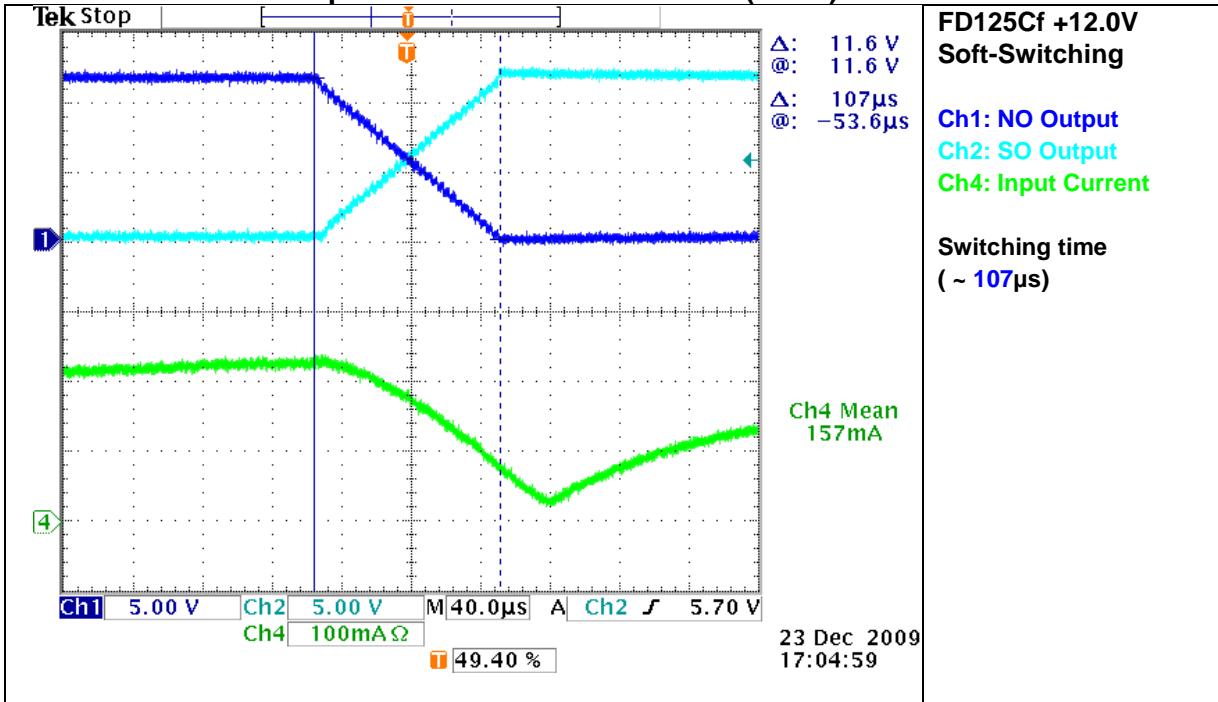

Figure.14

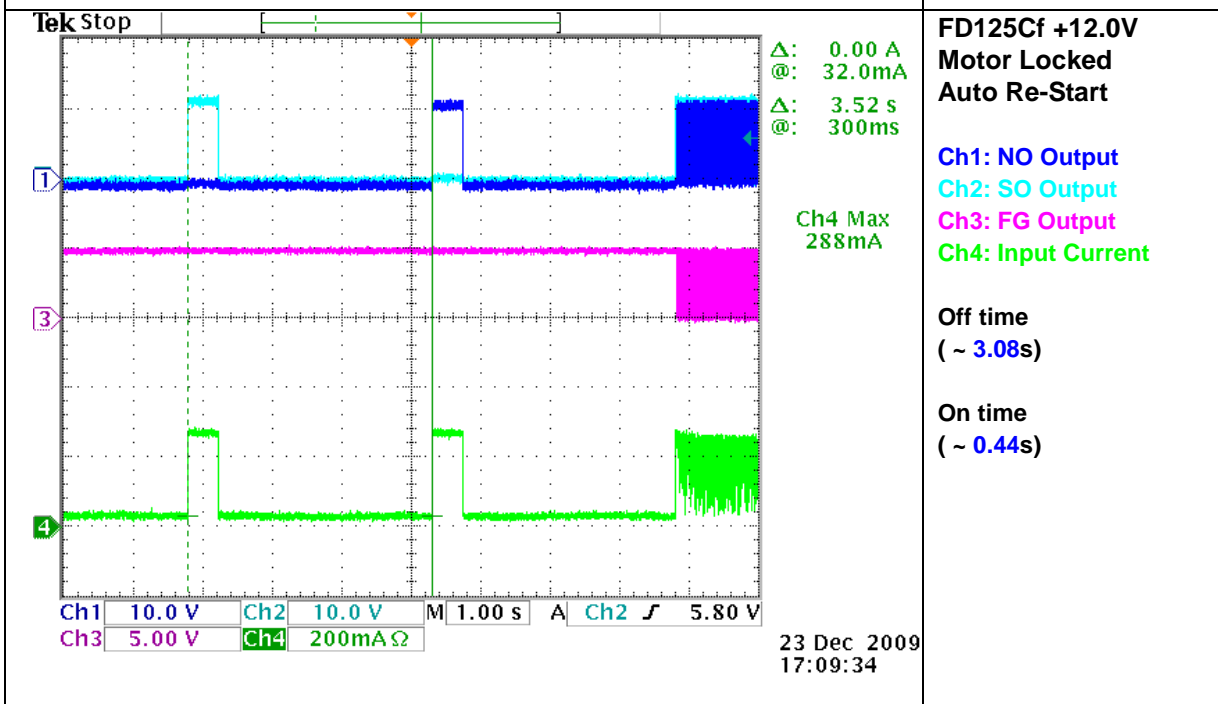

Figure.15



FD125Cf/FD125Mf Output Waveforms Measurement (Con't)

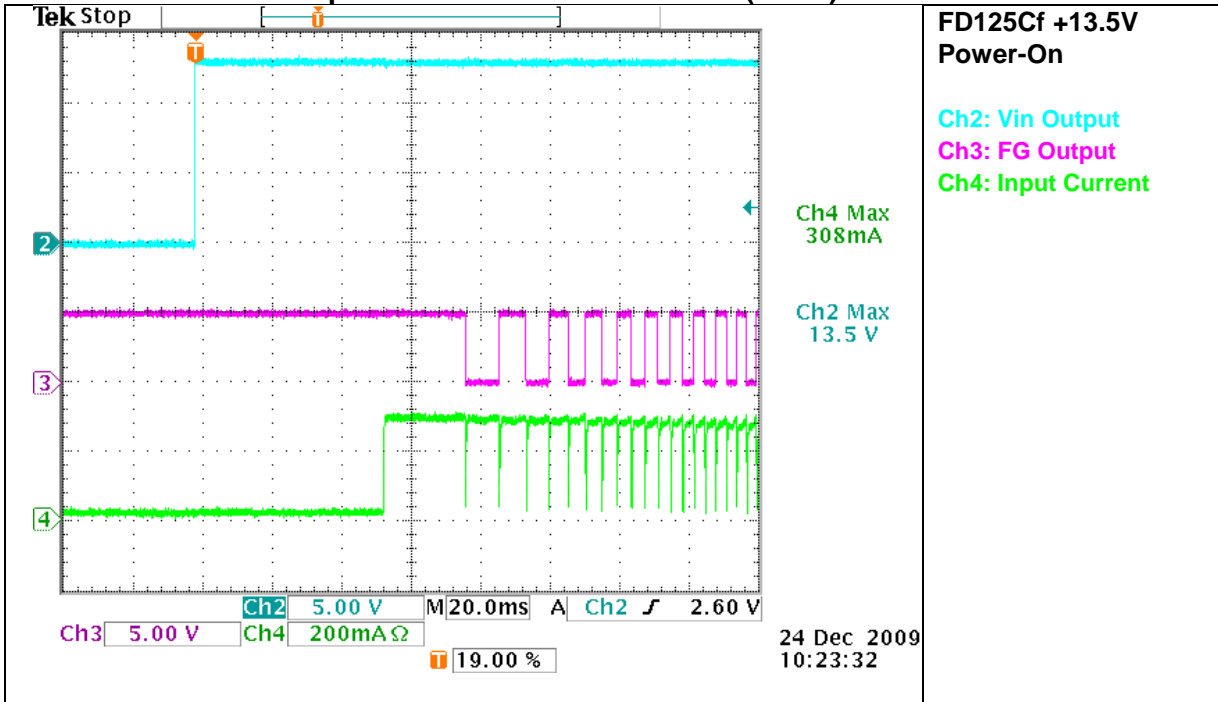

Figure.16

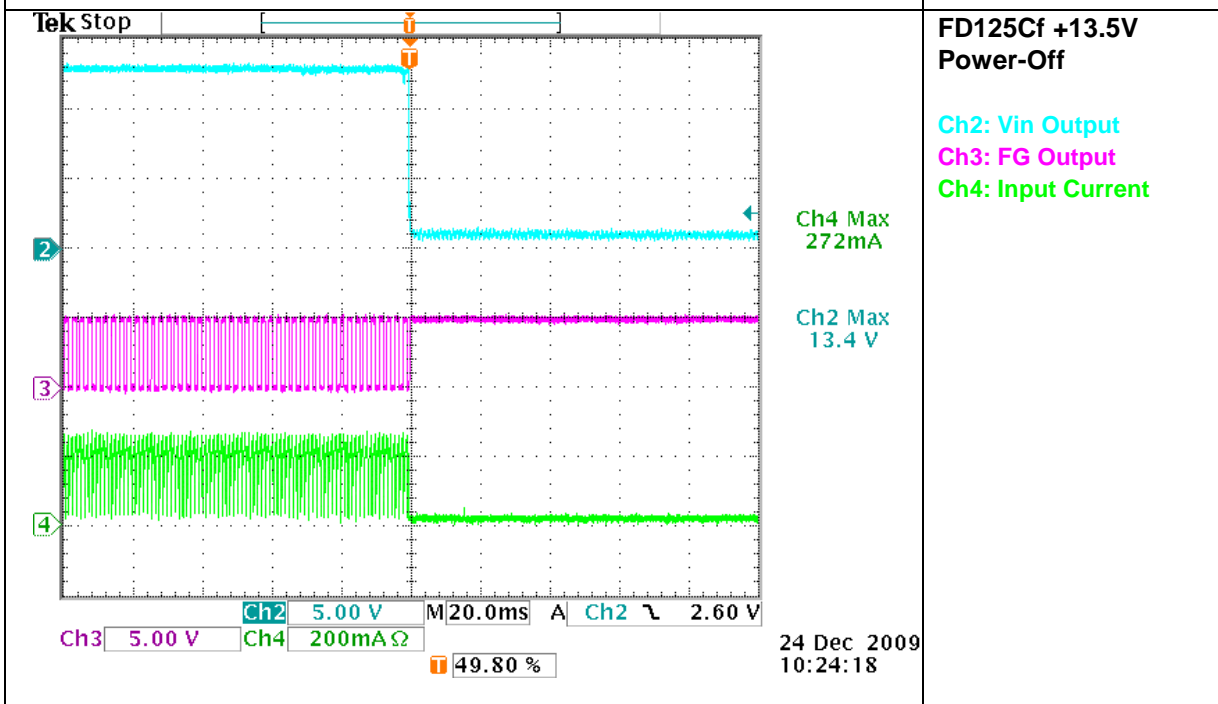
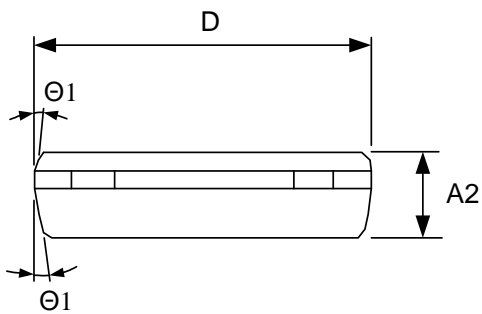
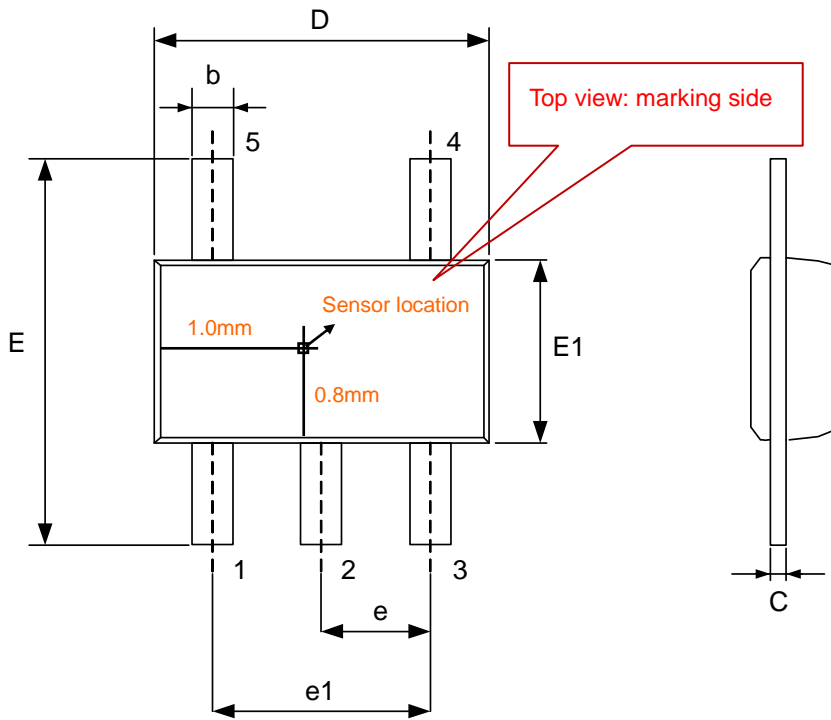

Figure.17

Package Dimension (Unit: mm)
TS825 (Halogen Free)

Symbols	Dimension In Millimeters		
	Min	Nom	Max
A2	0.700	0.750	0.775
b	0.350	-	0.500
c	0.100	-	0.200
D	2.800	2.900	3.100
E	3.700	3.800	3.900
E1	1.500	1.600	1.700
e	0.950 BSC		
e1	1.900 BSC		
Θ1	4°	10°	12°



Packing Specification (Tapping Reel)

TS825

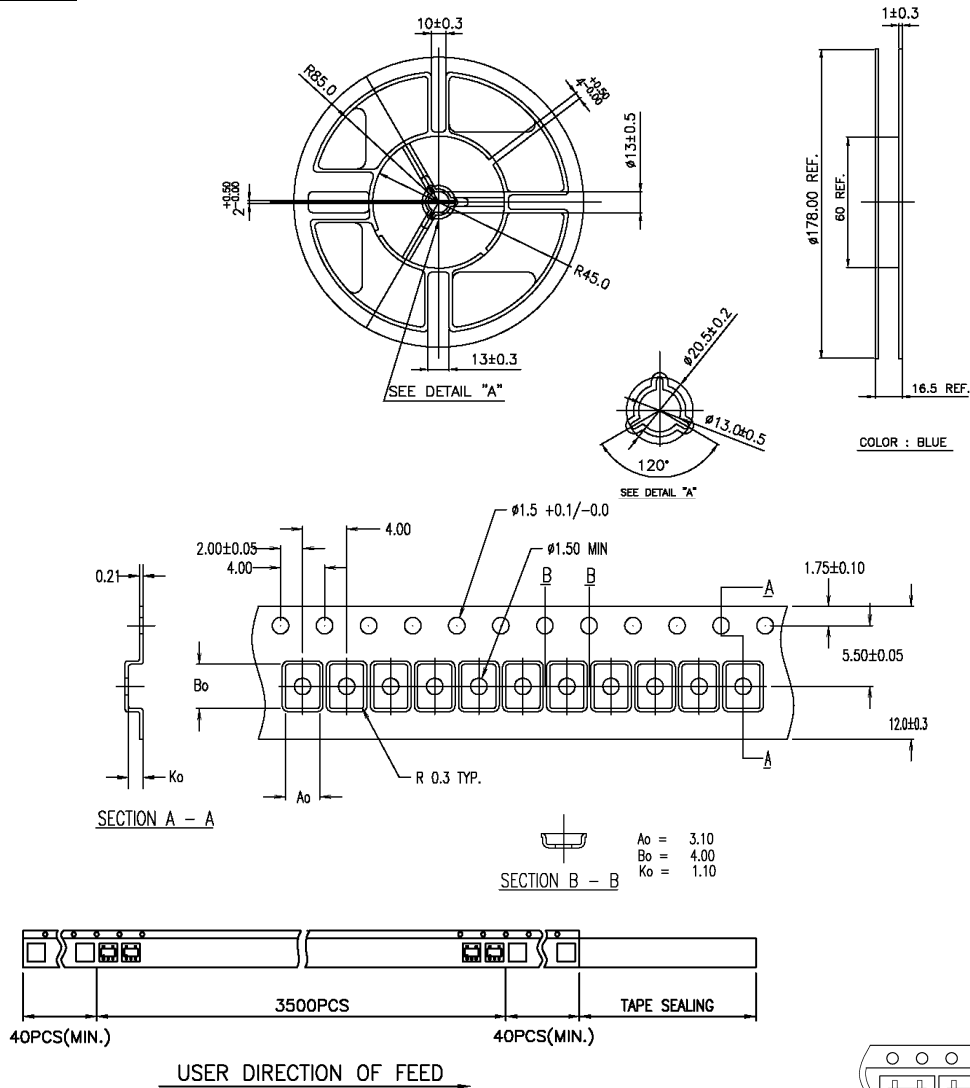

Notes:

1. 10 sprocket hole pitch cumulative tolerance ± 0.2 mm
2. Camber not to exceed 1mm in 100mm.
3. Material: Anti-Static Black Advantek Polystyrene.
4. A_o and B_o measured on a plane 0.3mm above the bottom of the pocket.
5. K_o measured from a plane on the inside bottom of the pocket to the top surface of the carrier.
6. Pocket position relative to sprocket hole measured as true position of pocket, not pocket hole.

PACKING QUANTITY SPECIFICATION

3,500ea / 1 Reel

3 Reels / 1 INSIDE BOX

4 INSIDE BOXes / 1 OUTSIDE BOX

TSOT-25 (F/P : 2.2mm 平脚)
包装方式: 3500 EA/PER REEL

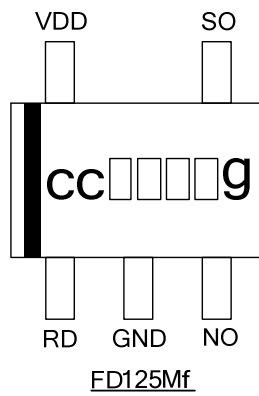
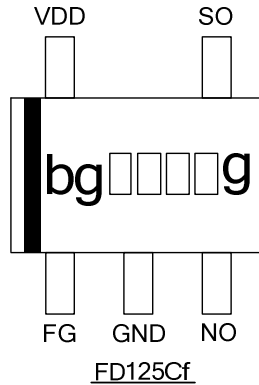
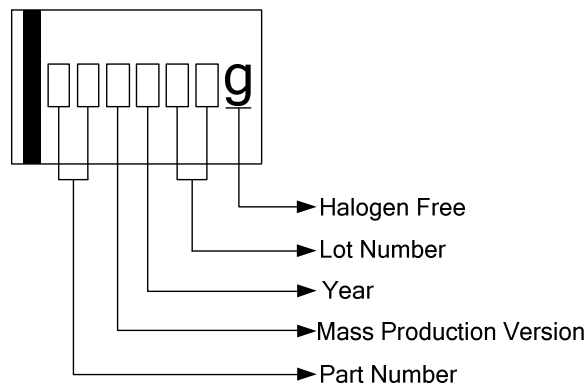
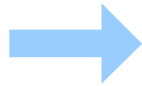
IC Pin Connection

Marking Distinguish

Order Information

Part Number	Operating Temperature	Package	Description	MOQ	MSL
FD125CfR-G1	-20 °C to +85 °C	TS825	±25G (B)	3,500EA / BAG	3
FD125MfR-G1			Alarm O/P		