



Is Now Part of



ON Semiconductor®

To learn more about ON Semiconductor, please visit our website at
www.onsemi.com

Please note: As part of the Fairchild Semiconductor integration, some of the Fairchild orderable part numbers will need to change in order to meet ON Semiconductor's system requirements. Since the ON Semiconductor product management systems do not have the ability to manage part nomenclature that utilizes an underscore (_), the underscore (_) in the Fairchild part numbers will be changed to a dash (-). This document may contain device numbers with an underscore (_). Please check the ON Semiconductor website to verify the updated device numbers. The most current and up-to-date ordering information can be found at www.onsemi.com. Please email any questions regarding the system integration to Fairchild_questions@onsemi.com.

ON Semiconductor and the ON Semiconductor logo are trademarks of Semiconductor Components Industries, LLC dba ON Semiconductor or its subsidiaries in the United States and/or other countries. ON Semiconductor owns the rights to a number of patents, trademarks, copyrights, trade secrets, and other intellectual property. A listing of ON Semiconductor's product/patent coverage may be accessed at www.onsemi.com/site/pdf/Patent-Marking.pdf. ON Semiconductor reserves the right to make changes without further notice to any products herein. ON Semiconductor makes no warranty, representation or guarantee regarding the suitability of its products for any particular purpose, nor does ON Semiconductor assume any liability arising out of the application or use of any product or circuit, and specifically disclaims any and all liability, including without limitation special, consequential or incidental damages. Buyer is responsible for its products and applications using ON Semiconductor products, including compliance with all laws, regulations and safety requirements or standards, regardless of any support or applications information provided by ON Semiconductor. "Typical" parameters which may be provided in ON Semiconductor data sheets and/or specifications can and do vary in different applications and actual performance may vary over time. All operating parameters, including "Typicals" must be validated for each customer application by customer's technical experts. ON Semiconductor does not convey any license under its patent rights nor the rights of others. ON Semiconductor products are not designed, intended, or authorized for use as a critical component in life support systems or any FDA Class 3 medical devices or medical devices with a same or similar classification in a foreign jurisdiction or any devices intended for implantation in the human body. Should Buyer purchase or use ON Semiconductor products for any such unintended or unauthorized application, Buyer shall indemnify and hold ON Semiconductor and its officers, employees, subsidiaries, affiliates, and distributors harmless against all claims, costs, damages, and expenses, and reasonable attorney fees arising out of, directly or indirectly, any claim of personal injury or death associated with such unintended or unauthorized use, even if such claim alleges that ON Semiconductor was negligent regarding the design or manufacture of the part. ON Semiconductor is an Equal Opportunity/Affirmative Action Employer. This literature is subject to all applicable copyright laws and is not for resale in any manner.

FDC6333C

30V N & P-Channel PowerTrench[®] MOSFETs

General Description

These N & P-Channel MOSFETs are produced using Fairchild Semiconductor's advanced PowerTrench process that has been especially tailored to minimize on-state resistance and yet maintain superior switching performance.

These devices have been designed to offer exceptional power dissipation in a very small footprint for applications where the bigger more expensive SO-8 and TSSOP-8 packages are impractical.

Applications

- DC/DC converter
- Load switch
- LCD display inverter

Features

- **Q1** 2.5 A, 30V. $R_{DS(ON)} = 95 \text{ m}\Omega @ V_{GS} = 10 \text{ V}$
 $R_{DS(ON)} = 150 \text{ m}\Omega @ V_{GS} = 4.5 \text{ V}$
- **Q2** -2.0 A, 30V. $R_{DS(ON)} = 150 \text{ m}\Omega @ V_{GS} = -10 \text{ V}$
 $R_{DS(ON)} = 220 \text{ m}\Omega @ V_{GS} = -4.5 \text{ V}$
- Low gate charge
- High performance trench technology for extremely low $R_{DS(ON)}$.
- SuperSOT -6 package: small footprint (72% smaller than SO-8); low profile (1mm thick).

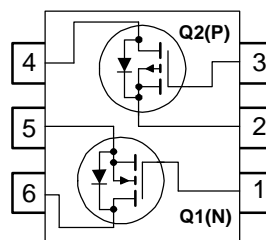
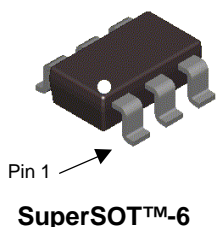

Absolute Maximum Ratings T_A=25°C unless otherwise noted

| Symbol | Parameter | Q1 | Q2 | Units |
|-----------------------------------|--|-------------|------|-------|
| V _{DSS} | Drain-Source Voltage | 30 | -30 | V |
| V _{GSS} | Gate-Source Voltage | ±16 | ±25 | V |
| I _D | Drain Current – Continuous (Note 1a) | 2.5 | -2.0 | A |
| | – Pulsed | 8 | -8 | |
| P _D | Power Dissipation for Single Operation (Note 1a) (Note 1b) (Note 1c) | 0.96 | | W |
| | | 0.9 | | |
| | | 0.7 | | |
| T _J , T _{STG} | Operating and Storage Junction Temperature Range | -55 to +150 | | °C |

Thermal Characteristics

| | | | |
|------------------|---|-----|------|
| R _{θJA} | Thermal Resistance, Junction-to-Ambient (Note 1a) | 130 | °C/W |
| R _{θJC} | Thermal Resistance, Junction-to-Case (Note 1) | 60 | °C/W |

Package Marking and Ordering Information

| Device Marking | Device | Reel Size | Tape width | Quantity |
|----------------|----------|-----------|------------|------------|
| .333 | FDC6333C | 7" | 8mm | 3000 units |

Electrical Characteristics

T_A = 25°C unless otherwise noted

| Symbol | Parameter | Test Conditions | Min | Typ | Max | Units |
|--------|-----------|-----------------|-----|-----|-----|-------|
|--------|-----------|-----------------|-----|-----|-----|-------|

Off Characteristics

| | | | | | | |
|--------------------------------------|---|---|----------|-----------|--------------|-------|
| BV _{DSS} | Drain–Source Breakdown Voltage | V _{GS} = 0 V, I _D = 250 μA V _{GS} = 0 V, I _D = –250 μA | Q1 Q2 | 30 –30 | | V |
| $\frac{\Delta BV_{DSS}}{\Delta T_J}$ | Breakdown Voltage Temperature Coefficient | I _D = 250 μA, Ref. to 25°C I _D = –250 μA, Ref. to 25°C | Q1 Q2 | | 27 –22 | mV/°C |
| I _{DSS} | Zero Gate Voltage Drain Current | V _{DS} = 24 V, V _{GS} = 0 V V _{DS} = –24 V, V _{GS} = 0 V | Q1 Q2 | | 1 –1 | μA |
| I _{GSSF} | Gate–Body Leakage, Forward | V _{GS} = 16 V, V _{DS} = 0 V V _{GS} = 25 V, V _{DS} = 0 V | Q1 Q2 | | 100 100 | nA |
| I _{GSSR} | Gate–Body Leakage, Reverse | V _{GS} = –16 V, V _{DS} = 0 V V _{GS} = –25 V, V _{DS} = 0 V | Q1 Q2 | | –100 –100 | nA |

On Characteristics (Note 2)

| | | | | | | | |
|--|--|----|--|----|------------------|-------------------|-------|
| V _{GS(th)} | Gate Threshold Voltage | Q1 | V _{DS} = V _{GS} , I _D = 250 μA | 1 | 1.8 | 3 | V |
| | | Q2 | V _{DS} = V _{GS} , I _D = –250 μA | –1 | –1.8 | –3 | |
| $\frac{\Delta V_{GS(th)}}{\Delta T_J}$ | Gate Threshold Voltage Temperature Coefficient | Q1 | I _D = 250 μA, Ref. To 25°C | | 4 | | mV/°C |
| | | Q2 | I _D = –250 μA, Ref. to 25°C | | –4 | | |
| R _{DS(on)} | Static Drain–Source On–Resistance | Q1 | V _{GS} = 10 V, I _D = 2.5 A V _{GS} = 4.5 V, I _D = 2.0 A V _{GS} = 10 V, I _D = 2.5 A, T _J = 125°C | | 73 90 106 | 95 150 148 | mΩ |
| | | Q2 | V _{GS} = –10 V, I _D = –2.0 A V _{GS} = –4.5 V, I _D = –1.7 A V _{GS} = 10 V, I _D = –2.0 A, T _J = 125°C | | 95 142 149 | 130 220 216 | |
| I _{D(on)} | On–State Drain Current | Q1 | V _{GS} = 10 V, V _{DS} = 5 V | 8 | | | A |
| | | Q2 | V _{GS} = –10 V, V _{DS} = –5 V | –8 | | | |
| g _{FS} | Forward Transconductance | Q1 | V _{DS} = 5 V, I _D = 2.5 A | | 7 | | S |
| | | Q2 | V _{DS} = –5 V, I _D = –2.0 A | | 3 | | |

Dynamic Characteristics

| | | | | | | | |
|------------------|------------------------------|----|---|--|-----|--|----|
| C _{iss} | Input Capacitance | Q1 | V _{DS} = 15 V, V _{GS} = 0 V, f = 1.0 MHz | | 282 | | pF |
| | | Q2 | V _{DS} = –15 V, V _{GS} = 0 V, f = 1.0 MHz | | 185 | | |
| C _{oss} | Output Capacitance | Q1 | V _{DS} = 15 V, V _{GS} = 0 V, f = 1.0 MHz | | 49 | | pF |
| | | Q2 | V _{DS} = –15 V, V _{GS} = 0 V, f = 1.0 MHz | | 56 | | |
| C _{rss} | Reverse Transfer Capacitance | Q1 | V _{DS} = 15 V, V _{GS} = 0 V, f = 1.0 MHz | | 20 | | pF |
| | | Q2 | V _{DS} = –15 V, V _{GS} = 0 V, f = 1.0 MHz | | 26 | | |

Switching Characteristics (Note 2)

| | | | | | | | |
|---------------------|---------------------|----|---|--|-----|-----|----|
| t _{d(on)} | Turn–On Delay Time | Q1 | For Q1: V _{DS} = 15 V, I _{DS} = 1 A V _{GS} = 10 V, R _{GEN} = 6 Ω | | 4.5 | 9 | ns |
| | | Q2 | | | 4.5 | 9 | |
| t _r | Turn–On Rise Time | Q1 | For Q2: V _{DS} = –15 V, I _{DS} = –1 A V _{GS} = –10 V, R _{GEN} = 6 Ω | | 6 | 12 | ns |
| | | Q2 | | | 13 | 23 | |
| t _{d(off)} | Turn–Off Delay Time | Q1 | | | 19 | 34 | ns |
| | | Q2 | | | 11 | 20 | |
| t _f | Turn–Off Fall Time | Q1 | | | 1.5 | 3 | ns |
| | | Q2 | | | 2 | 4 | |
| Q _g | Total Gate Charge | Q1 | For Q1: V _{DS} = 15 V, I _{DS} = 2.5 A V _{GS} = 10 V, R _{GEN} = 6 Ω | | 4.7 | 6.6 | nC |
| | | Q2 | | | 4.1 | 5.7 | |
| Q _{gs} | Gate–Source Charge | Q1 | For Q2: V _{DS} = –15 V, I _{DS} = –2.0 A V _{GS} = –10 V, | | 0.9 | | nC |
| | | Q2 | | | 0.8 | | |
| Q _{gd} | Gate–Drain Charge | Q1 | | | 0.6 | | nC |
| | | Q2 | | | 0.4 | | |

Electrical Characteristics

$T_A = 25^\circ\text{C}$ unless otherwise noted

| Symbol | Parameter | Test Conditions | Min | Typ | Max | Units |
|--------|-----------|-----------------|-----|-----|-----|-------|
|--------|-----------|-----------------|-----|-----|-----|-------|

Drain–Source Diode Characteristics and Maximum Ratings

| | | | | | | | |
|----------|---|----|---|----------|------|------|---|
| I_S | Maximum Continuous Drain–Source Diode Forward Current | Q1 | | | 0.8 | A | |
| | | Q2 | | | -0.8 | | |
| V_{SD} | Drain–Source Diode Forward Voltage | Q1 | $V_{GS} = 0\text{ V}, I_S = 0.8\text{ A}$ | (Note 2) | 0.8 | 1.2 | V |
| | | Q2 | $V_{GS} = 0\text{ V}, I_S = 0.8\text{ A}$ | (Note 2) | 0.8 | -1.2 | |

Notes:

1. $R_{\theta JA}$ is the sum of the junction-to-case and case-to-ambient thermal resistance where the case thermal reference is defined as the solder mounting surface of the drain pins. $R_{\theta JC}$ is guaranteed by design while $R_{\theta CA}$ is determined by the user's board design.

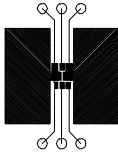

a) 130°C/W when mounted on a 0.125 in^2 pad of 2 oz. copper.

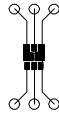

b) 140°C/W when mounted on a $.004\text{ in}^2$ pad of 2 oz copper

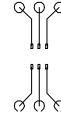

c) 180°C/W when mounted on a minimum pad.

Scale 1 : 1 on letter size paper

2. Pulse Test: Pulse Width < $300\mu\text{s}$, Duty Cycle < 2.0%

Typical Characteristics: N-Channel

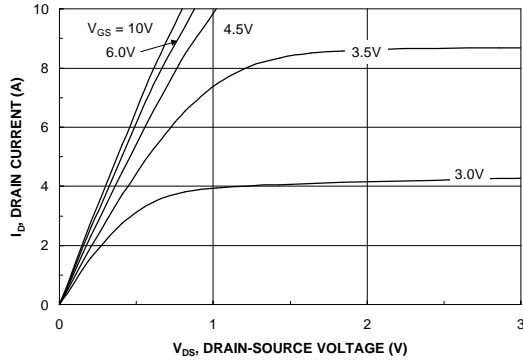

Figure 1. On-Region Characteristics.

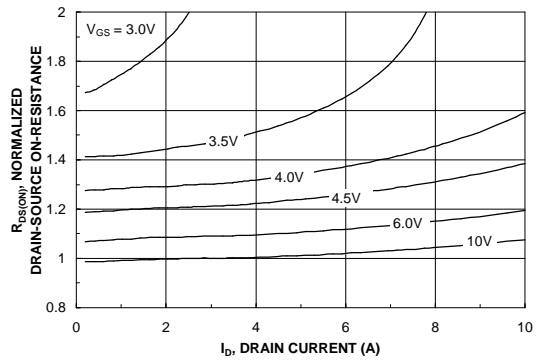

Figure 2. On-Resistance Variation with Drain Current and Gate Voltage.

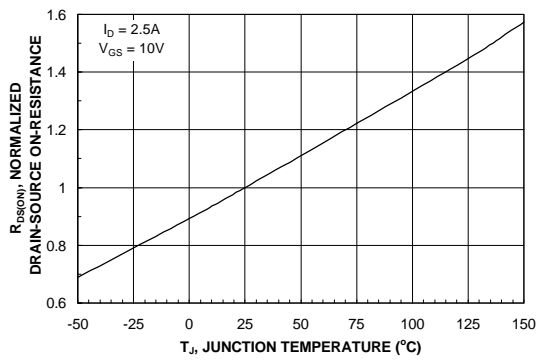

Figure 3. On-Resistance Variation with Temperature.

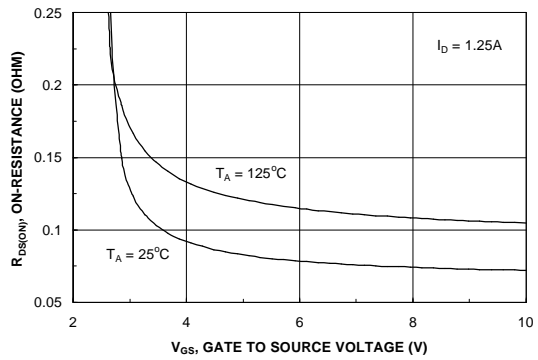

Figure 4. On-Resistance Variation with Gate-to-Source Voltage.

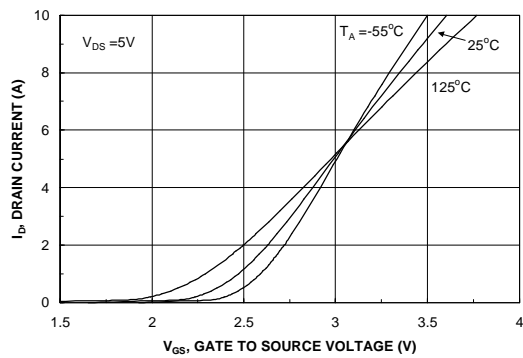

Figure 5. Transfer Characteristics.

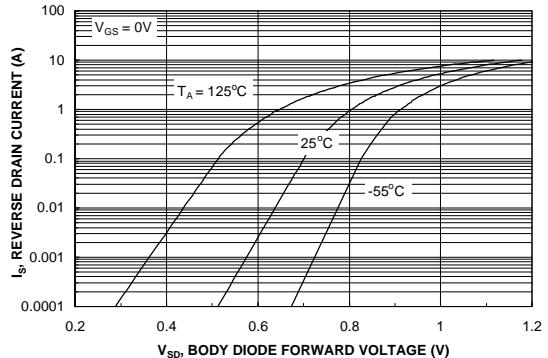

Figure 6. Body Diode Forward Voltage Variation with Source Current and Temperature.

Typical Characteristics: N-Channel (continued)

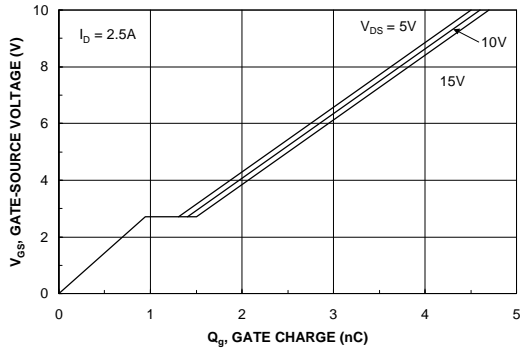

Figure 7. Gate Charge Characteristics.

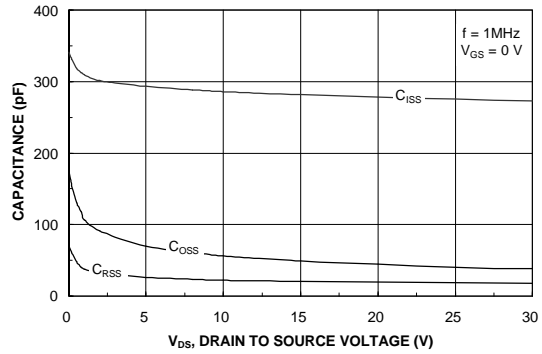

Figure 8. Capacitance Characteristics.

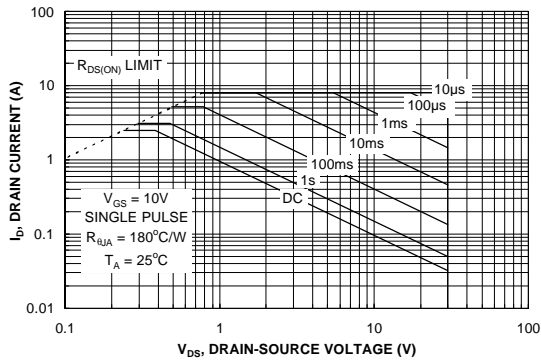

Figure 9. Maximum Safe Operating Area.

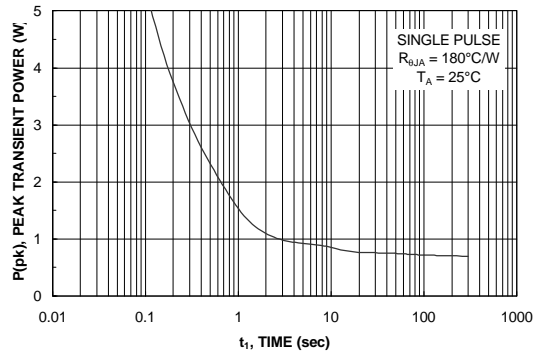

Figure 10. Single Pulse Maximum Power Dissipation.

Typical Characteristics: P-Channel

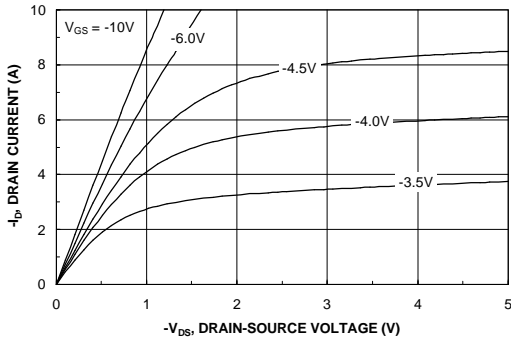

Figure 11. On-Region Characteristics.

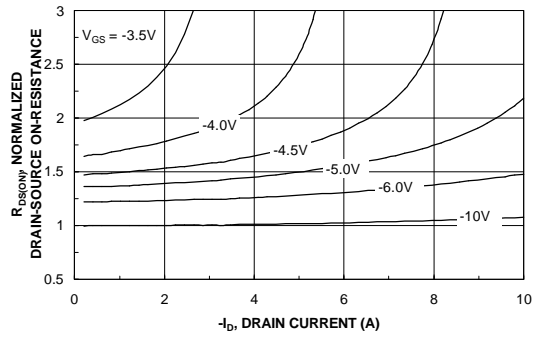

Figure 12. On-Resistance Variation with Drain Current and Gate Voltage.

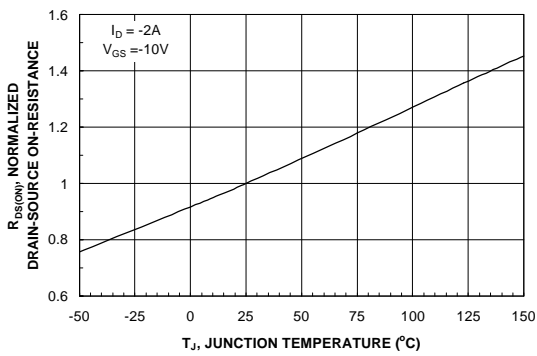

Figure 13. On-Resistance Variation with Temperature.

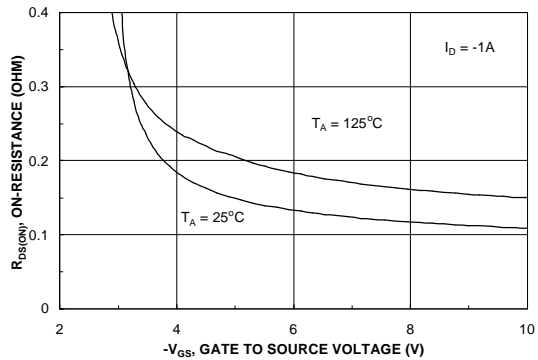

Figure 14. On-Resistance Variation with Gate-to-Source Voltage.

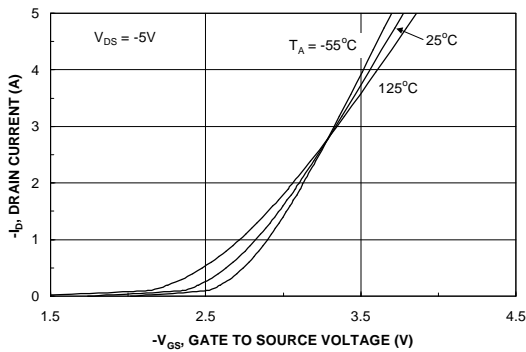

Figure 15. Transfer Characteristics.

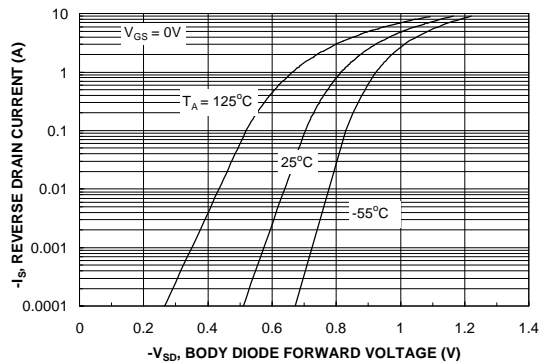

Figure 16. Body Diode Forward Voltage Variation with Source Current and Temperature.

Typical Characteristics: P-Channel (continued)

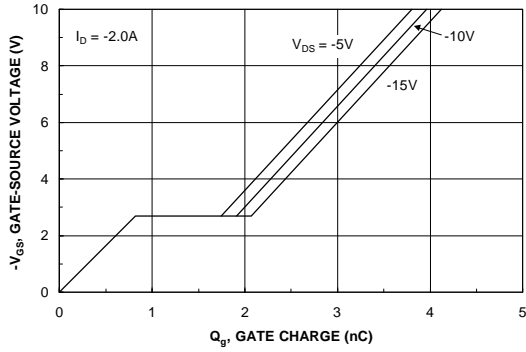

Figure 17. Gate Charge Characteristics.

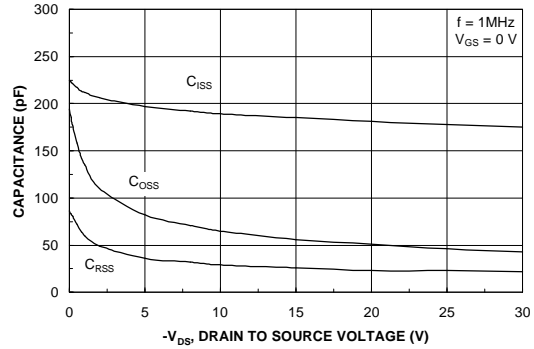

Figure 18. Capacitance Characteristics.

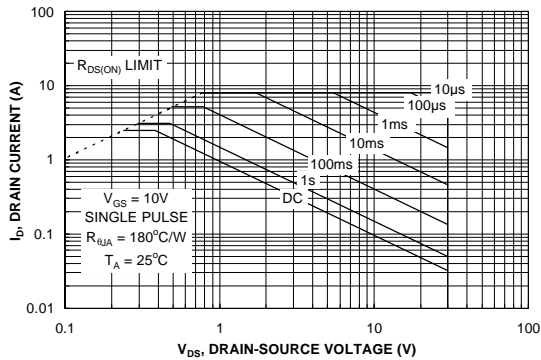

Figure 19. Maximum Safe Operating Area.

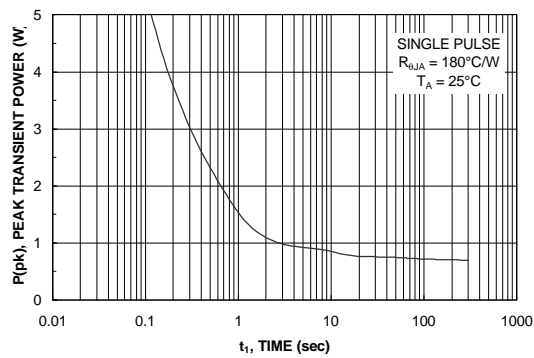

Figure 20. Single Pulse Maximum Power Dissipation.

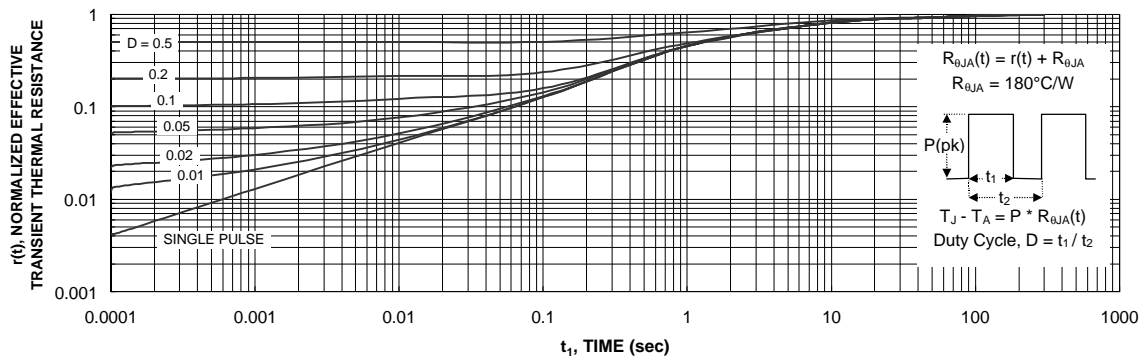

Figure 21. Transient Thermal Response Curve.

Thermal characterization performed using the conditions described in Note 1c.
Transient thermal response will change depending on the circuit board design.

TRADEMARKS

The following are registered and unregistered trademarks Fairchild Semiconductor owns or is authorized to use and is not intended to be an exhaustive list of all such trademarks.

| | | | | |
|-----------------------------------|----------------------------------|----------------------------------|------------------------------|-------------------|
| ACE _x TM | FAST [®] | OPTOLOGIC TM | SMART START TM | VCX TM |
| Bottomless TM | FAST _r TM | OPTOPLANAR TM | STAR*POWER TM | |
| CoolFET TM | FRFET TM | PACMAN TM | Stealth TM | |
| CROSSVOLT TM | GlobalOptoisolator TM | POP TM | SuperSOT TM -3 | |
| DenseTrench TM | GTO TM | Power247 TM | SuperSOT TM -6 | |
| DOMET TM | HiSeC TM | PowerTrench [®] | SuperSOT TM -8 | |
| EcoSPARK TM | ISOPLANAR TM | QFET TM | SyncFET TM | |
| E ² CMOS TM | LittleFET TM | QS TM | TinyLogic TM | |
| EnSigna TM | MicroFET TM | QT Optoelectronics TM | TruTranslation TM | |
| FACT TM | MicroPak TM | Quiet Series TM | UHC TM | |
| FACT Quiet Series TM | MICROWIRE TM | SILENT SWITCHER [®] | UltraFET [®] | |

STAR*POWER is used under license

DISCLAIMER

FAIRCHILD SEMICONDUCTOR RESERVES THE RIGHT TO MAKE CHANGES WITHOUT FURTHER NOTICE TO ANY PRODUCTS HEREIN TO IMPROVE RELIABILITY, FUNCTION OR DESIGN. FAIRCHILD DOES NOT ASSUME ANY LIABILITY ARISING OUT OF THE APPLICATION OR USE OF ANY PRODUCT OR CIRCUIT DESCRIBED HEREIN; NEITHER DOES IT CONVEY ANY LICENSE UNDER ITS PATENT RIGHTS, NOR THE RIGHTS OF OTHERS.

LIFE SUPPORT POLICY

FAIRCHILD'S PRODUCTS ARE NOT AUTHORIZED FOR USE AS CRITICAL COMPONENTS IN LIFE SUPPORT DEVICES OR SYSTEMS WITHOUT THE EXPRESS WRITTEN APPROVAL OF FAIRCHILD SEMICONDUCTOR CORPORATION.

As used herein:

1. Life support devices or systems are devices or systems which, (a) are intended for surgical implant into the body, or (b) support or sustain life, or (c) whose failure to perform when properly used in accordance with instructions for use provided in the labeling, can be reasonably expected to result in significant injury to the user.
2. A critical component is any component of a life support device or system whose failure to perform can be reasonably expected to cause the failure of the life support device or system, or to affect its safety or effectiveness.

PRODUCT STATUS DEFINITIONS

Definition of Terms

| Datasheet Identification | Product Status | Definition |
|--------------------------|------------------------|---|
| Advance Information | Formative or In Design | This datasheet contains the design specifications for product development. Specifications may change in any manner without notice. |
| Preliminary | First Production | This datasheet contains preliminary data, and supplementary data will be published at a later date. Fairchild Semiconductor reserves the right to make changes at any time without notice in order to improve design. |
| No Identification Needed | Full Production | This datasheet contains final specifications. Fairchild Semiconductor reserves the right to make changes at any time without notice in order to improve design. |
| Obsolete | Not In Production | This datasheet contains specifications on a product that has been discontinued by Fairchild semiconductor. The datasheet is printed for reference information only. |

ON Semiconductor and  are trademarks of Semiconductor Components Industries, LLC dba ON Semiconductor or its subsidiaries in the United States and/or other countries. ON Semiconductor owns the rights to a number of patents, trademarks, copyrights, trade secrets, and other intellectual property. A listing of ON Semiconductor's product/patent coverage may be accessed at www.onsemi.com/site/pdf/Patent-Marking.pdf. ON Semiconductor reserves the right to make changes without further notice to any products herein. ON Semiconductor makes no warranty, representation or guarantee regarding the suitability of its products for any particular purpose, nor does ON Semiconductor assume any liability arising out of the application or use of any product or circuit, and specifically disclaims any and all liability, including without limitation special, consequential or incidental damages. Buyer is responsible for its products and applications using ON Semiconductor products, including compliance with all laws, regulations and safety requirements or standards, regardless of any support or applications information provided by ON Semiconductor. "Typical" parameters which may be provided in ON Semiconductor data sheets and/or specifications can and do vary in different applications and actual performance may vary over time. All operating parameters, including "Typicals" must be validated for each customer application by customer's technical experts. ON Semiconductor does not convey any license under its patent rights nor the rights of others. ON Semiconductor products are not designed, intended, or authorized for use as a critical component in life support systems or any FDA Class 3 medical devices or medical devices with a same or similar classification in a foreign jurisdiction or any devices intended for implantation in the human body. Should Buyer purchase or use ON Semiconductor products for any such unintended or unauthorized application, Buyer shall indemnify and hold ON Semiconductor and its officers, employees, subsidiaries, affiliates, and distributors harmless against all claims, costs, damages, and expenses, and reasonable attorney fees arising out of, directly or indirectly, any claim of personal injury or death associated with such unintended or unauthorized use, even if such claim alleges that ON Semiconductor was negligent regarding the design or manufacture of the part. ON Semiconductor is an Equal Opportunity/Affirmative Action Employer. This literature is subject to all applicable copyright laws and is not for resale in any manner.

PUBLICATION ORDERING INFORMATION

LITERATURE FULFILLMENT:

Literature Distribution Center for ON Semiconductor
19521 E. 32nd Pkwy, Aurora, Colorado 80011 USA
Phone: 303-675-2175 or 800-344-3860 Toll Free USA/Canada
Fax: 303-675-2176 or 800-344-3867 Toll Free USA/Canada
Email: orderlit@onsemi.com

N. American Technical Support: 800-282-9855 Toll Free
USA/Canada
Europe, Middle East and Africa Technical Support:
Phone: 421 33 790 2910
Japan Customer Focus Center
Phone: 81-3-5817-1050

ON Semiconductor Website: www.onsemi.com
Order Literature: <http://www.onsemi.com/orderlit>
For additional information, please contact your local
Sales Representative