

**WPM1481**
**Single P-Channel, -12V, -5.1A, Power MOSFET**
[Http://www.sh-willsemi.com](http://www.sh-willsemi.com)

V <sub>DS</sub> (V)	Typical R <sub>ds(on)</sub> (Ω)	I <sub>D</sub> (A)
-12	0.024 @ V <sub>GS</sub> = - 4.5V	-5.5
	0.032 @ V <sub>GS</sub> = - 2.5V	-4.0
	0.047 @ V <sub>GS</sub> = - 1.8V	-2.5



DFN2\*2-6L

**Descriptions**

The WPM1481 is P-Channel enhancement MOS Field Effect Transistor. Uses advanced trench technology and design to provide excellent R<sub>DS (ON)</sub> with low gate charge. This device is suitable for use in DC-DC conversion, power switch and charging circuit. Standard Product WPM1481 is Pb-free.

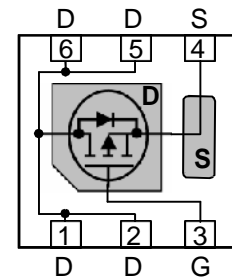
**Pin configuration (Top view)**
**Features**

- Trench Technology
- Supper high density cell design
- Excellent ON resistance for higher DC current
- Extremely Low Threshold Voltage
- Small package DFN2\*2-6L

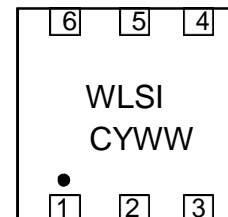

WLSI = Company Code  
 C = Device Code  
 Y = Year  
 WW = Week

**Marking**
**Applications**

- Driver for Relay, Solenoid, Motor, LED etc.
- DC-DC converter circuit
- Power Switch
- Load Switch
- Charging

**Order information**

Device	Package	Shipping
WPM1481- 6/TR	DFN2*2-6L	3000/Reel&Tape

**Absolute Maximum ratings**

Parameter		Symbol	10 S	Steady State	Unit
Drain-Source Voltage		$V_{DS}$	-12		V
Gate-Source Voltage		$V_{GS}$	$\pm 12$		
Continuous Drain Current <sup>a d</sup>	$T_A=25^\circ\text{C}$	$I_D$	-5.1	-4.3	A
	$T_A=70^\circ\text{C}$		-4.0	-3.4	
Maximum Power Dissipation <sup>a d</sup>	$T_A=25^\circ\text{C}$	$P_D$	1.9	1.4	W
	$T_A=70^\circ\text{C}$		1.2	0.9	
Continuous Drain Current <sup>b d</sup>	$T_A=25^\circ\text{C}$	$I_D$	-3.7	-3.0	A
	$T_A=70^\circ\text{C}$		-3.0	-2.4	
Maximum Power Dissipation <sup>b d</sup>	$T_A=25^\circ\text{C}$	$P_D$	1.0	0.6	W
	$T_A=70^\circ\text{C}$		0.6	0.4	
Pulsed Drain Current <sup>c</sup>		$I_{DM}$	-24		A
Operating Junction Temperature		$T_J$	-55~150		$^\circ\text{C}$
Lead Temperature		$T_L$	260		$^\circ\text{C}$
Storage Temperature Range		$T_{stg}$	-55 ~150		$^\circ\text{C}$

**Thermal resistance ratings**

Parameter		Symbol	Typical	Maximum	Unit
Junction-to-Ambient Thermal Resistance <sup>a</sup>	$t \leq 10 \text{ s}$	$R_{\theta JA}$	49	64	$^\circ\text{C/W}$
	Steady State		66	88	
Junction-to-Ambient Thermal Resistance <sup>b</sup>	$t \leq 10 \text{ s}$	$R_{\theta JA}$	84	118	
	Steady State		125	180	
Junction-to-Case Thermal Resistance		$R_{\theta JC}$	32	42	

a Surface mounted on FR-4 Board using 1 square inch pad size, 1oz copper

b Surface mounted on FR-4 board using minimum pad size, 1oz copper

c Pulse width < 380 $\mu\text{s}$ , Single pulse

d Maximum junction temperature  $T_J=150^\circ\text{C}$ .

e Pulse test: Pulse width < 380 us duty cycle < 2%.

**Electronics Characteristics (Ta=25°C, unless otherwise noted)**

Parameter	Symbol	Test Conditions	Min	Typ	Max	Unit
<b>OFF CHARACTERISTICS</b>						
Drain-to-Source Breakdown Voltage	BV <sub>DSS</sub>	V <sub>GS</sub> = 0 V, I <sub>D</sub> = -250uA	-12			V
Zero Gate Voltage Drain Current	I <sub>DSS</sub>	V <sub>DS</sub> = -10V, V <sub>GS</sub> = 0V			-1	uA
Gate-to-source Leakage Current	I <sub>GSS</sub>	V <sub>DS</sub> = 0 V, V <sub>GS</sub> = ±10V			±100	nA
<b>ON CHARACTERISTICS</b>						
Gate Threshold Voltage	V <sub>GS(TH)</sub>	V <sub>GS</sub> = V <sub>DS</sub> , I <sub>D</sub> = -250uA	-0.4		-0.9	V
Drain-to-source On-resistance <sup>b, e</sup>	R <sub>DS(on)</sub>	V <sub>GS</sub> = -4.5V, I <sub>D</sub> = -5.5A		24	28	mΩ
		V <sub>GS</sub> = -4.0V, I <sub>D</sub> = -4.0A		26	30	
		V <sub>GS</sub> = -2.5V, I <sub>D</sub> = -4.0A		32	40	
		V <sub>GS</sub> = -1.8V, I <sub>D</sub> = -2.5A		47	61	
Forward Transconductance <sup>e</sup>	g <sub>FS</sub>	V <sub>DS</sub> = -5.0V, I <sub>D</sub> = -5.5A		23		S
<b>CAPACITANCES, CHARGES</b>						
Input Capacitance	C <sub>ISS</sub>	V <sub>GS</sub> = 0 V, f = 1.0 MHz, V <sub>DS</sub> = -10 V		1880		pF
Output Capacitance	C <sub>OSS</sub>			437		
Reverse Transfer Capacitance	C <sub>RSS</sub>			413		
Total Gate Charge	Q <sub>G(TOT)</sub>	V <sub>GS</sub> = -4.5 V, V <sub>DS</sub> = -10 V, I <sub>D</sub> = -5.5A		44.5		nC
Threshold Gate Charge	Q <sub>G(TH)</sub>			3.5		
Gate-to-Source Charge	Q <sub>GS</sub>			1.7		
Gate-to-Drain Charge	Q <sub>GD</sub>			9.25		
<b>SWITCHING CHARACTERISTICS</b>						
Turn-On Delay Time	td <sub>(ON)</sub>	V <sub>GS</sub> = -4.5 V, V <sub>DS</sub> = -6 V, R <sub>L</sub> = 3 Ω, R <sub>G</sub> = 6 Ω		33.6		ns
Rise Time	tr			35.6		
Turn-Off Delay Time	td <sub>(OFF)</sub>			50		
Fall Time	tf			63		
<b>BODY DIODE CHARACTERISTICS</b>						
Forward Voltage	V <sub>SD</sub>	V <sub>GS</sub> = 0 V, I <sub>S</sub> = 1.0A		-0.76	-1.5	V

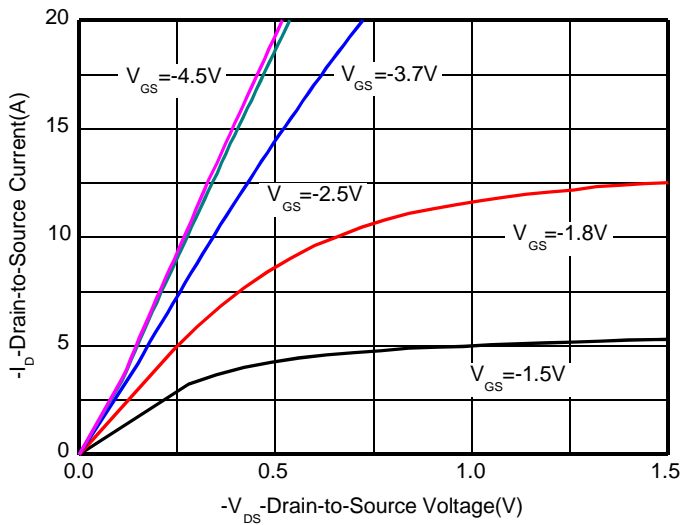
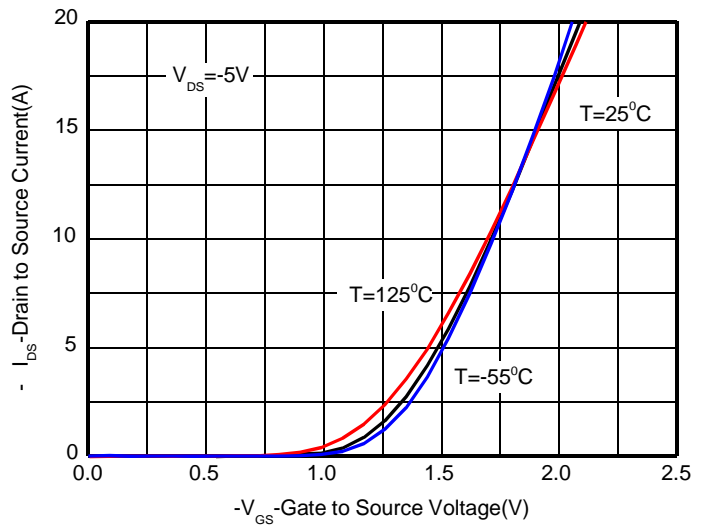
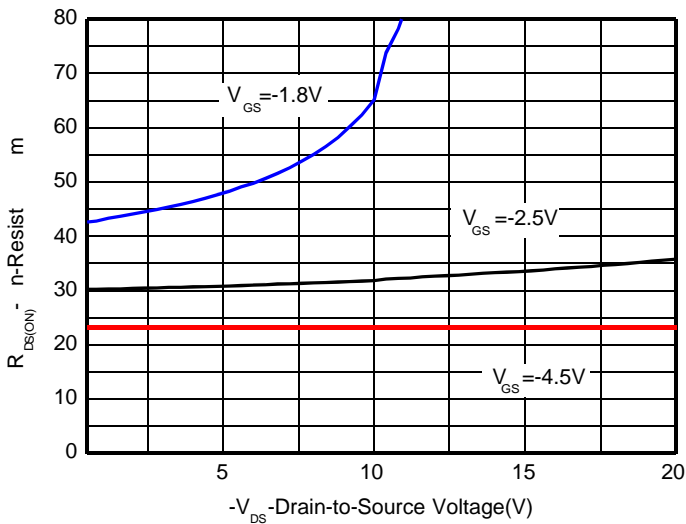
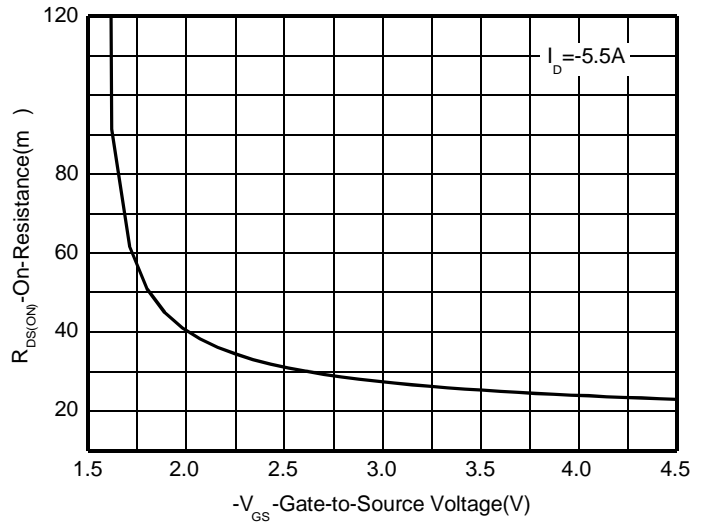
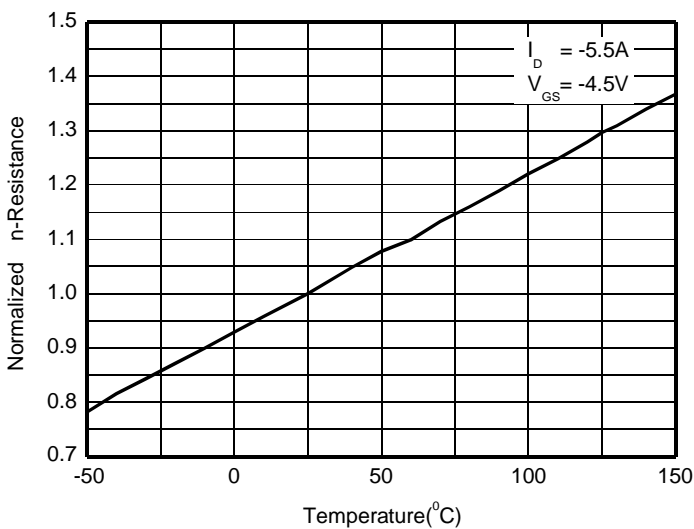
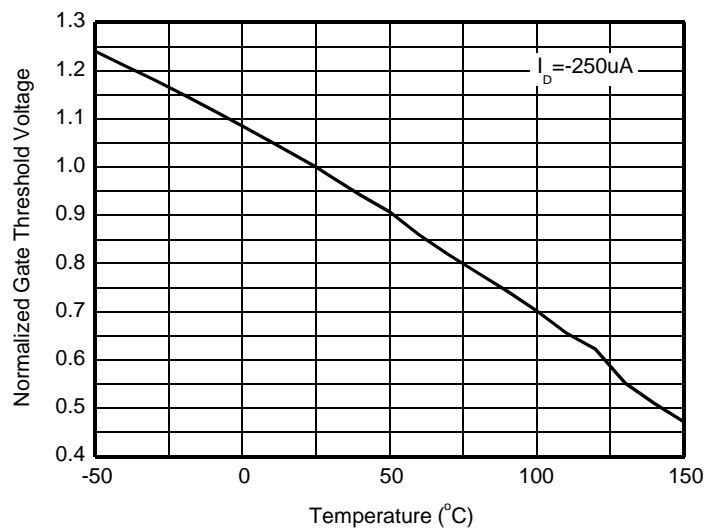
**Typical Characteristics (Ta=25°C, unless otherwise noted)**

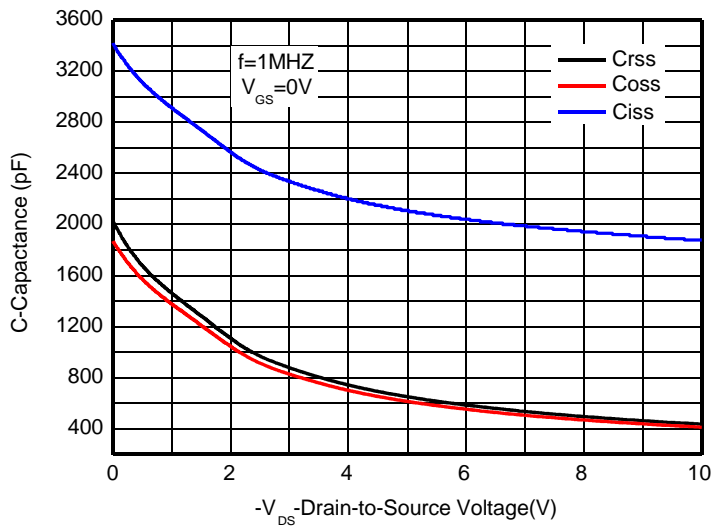
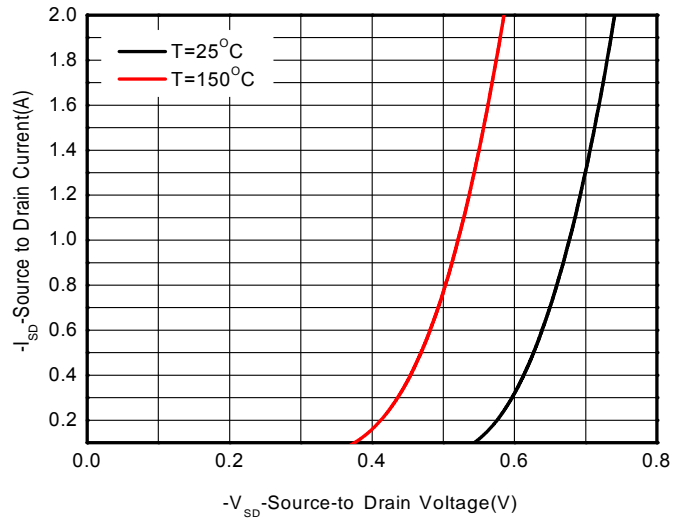
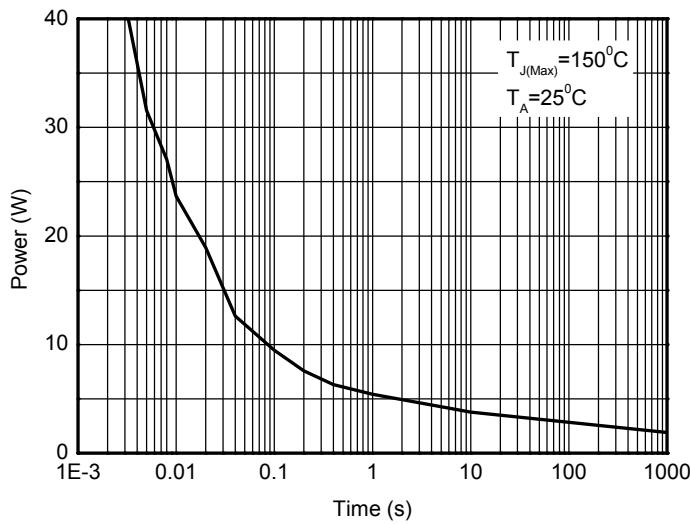
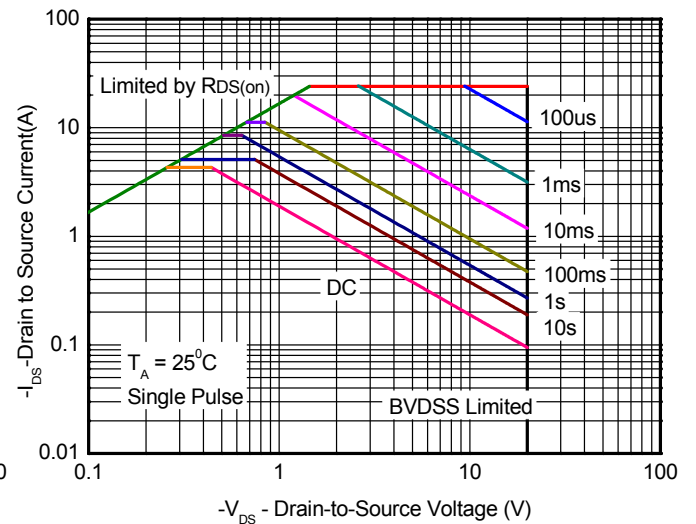
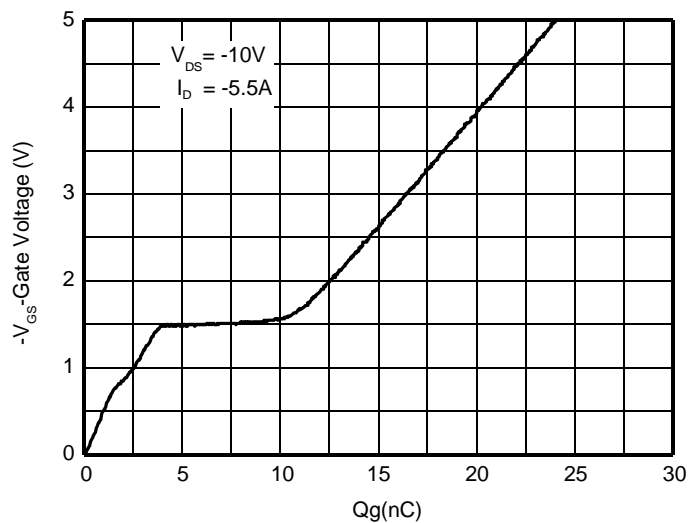
**Output characteristics**

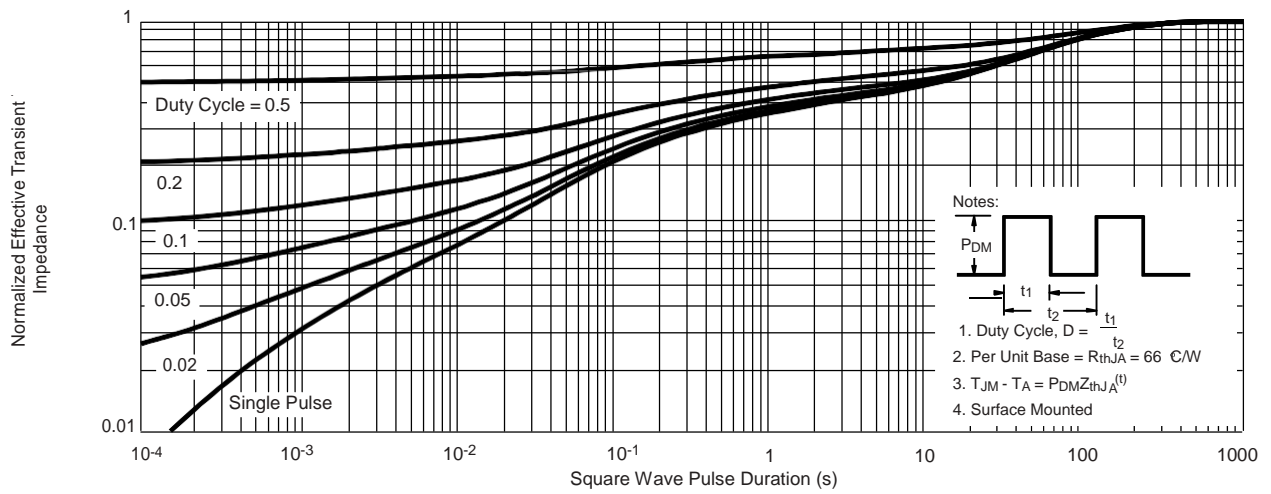
**Transfer characteristics**

**On-Resistance vs. Drain current**

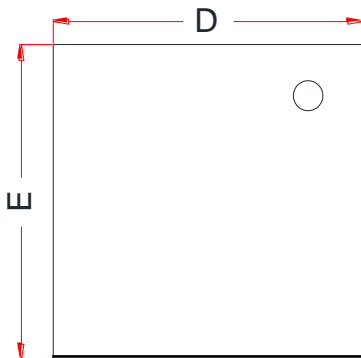
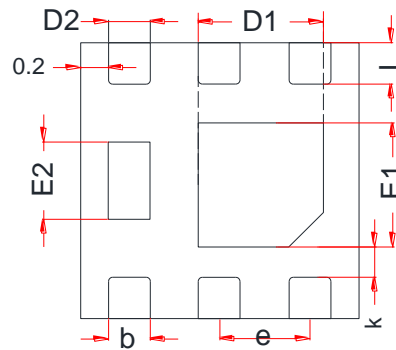
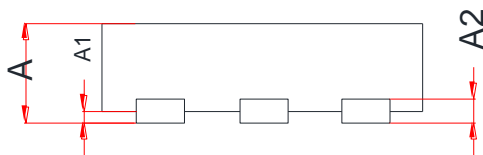
**On-Resistance vs. Gate-to-Source voltage**

**On-Resistance vs. Junction temperature**

**Threshold voltage vs. Temperature**



**Capacitance**

**Body diode forward voltage**

**Single pulse power**

**Safe operating power**

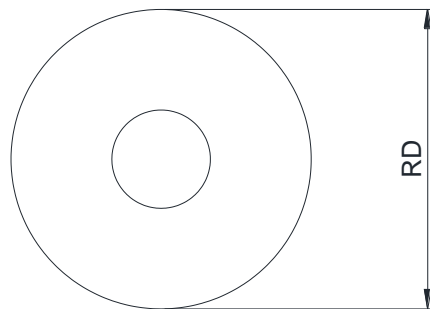
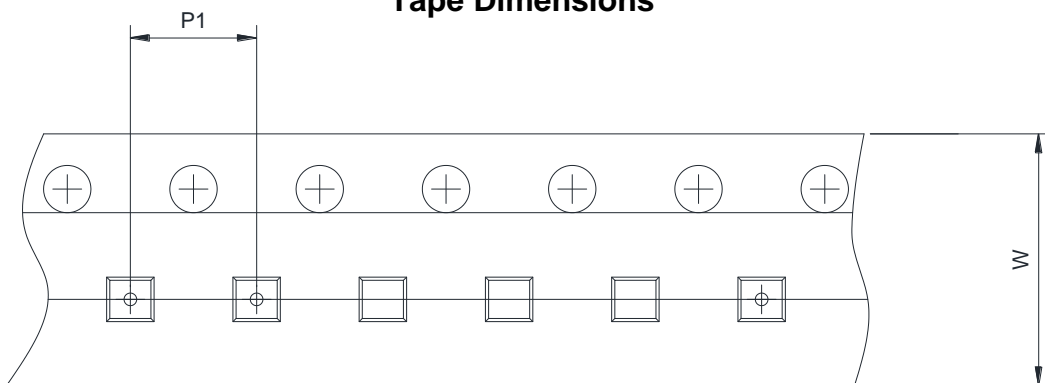
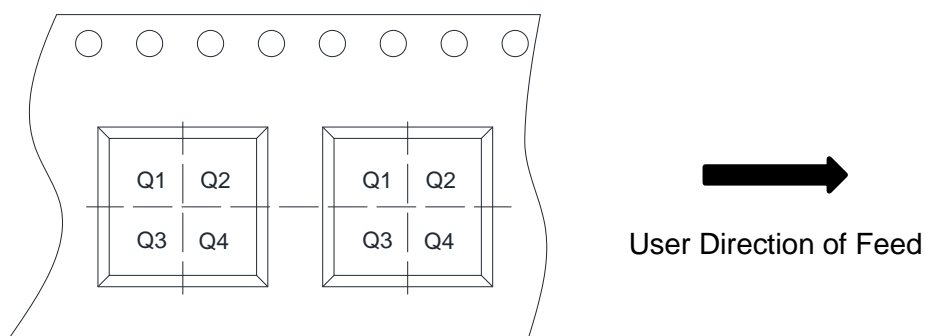
**Gate Charge Characteristics**



**Transient thermal response (Junction-to-Ambient)**

**PACKAGE OUTLINE DIMENSIONS**
**DFN2x2-6L**

**TOP VIEW**

**BOTTOM VIEW**

**SIDE VIEW**

Symbol	Dimensions in Millimeters		
	Min.	Typ.	Max.
A	0.70	0.75	0.85
A1	0.00	0.02	0.05
A2	0.20 Ref.		
b	0.25	0.30	0.35
D	1.95	2.00	2.05
D1	0.85	0.90	0.95
D2	0.25	0.30	0.35
E	1.95	2.00	2.05
E1	0.75	0.80	0.85
E2	0.56 Ref.		
e	0.65 BSC.		
L	0.30	0.35	0.40
K	0.20	-	-

**TAPE AND REEL INFORMATION**
**Reel Dimensions**

**Tape Dimensions**

**Quadrant Assignments For PIN1 Orientation In Tape**

RD	Reel Dimension	<input checked="" type="checkbox"/> 7inch <input type="checkbox"/> 13inch
W	Overall width of the carrier tape	<input checked="" type="checkbox"/> 8mm <input type="checkbox"/> 12mm <input type="checkbox"/> 16mm
P1	Pitch between successive cavity centers	<input type="checkbox"/> 2mm <input checked="" type="checkbox"/> 4mm <input type="checkbox"/> 8mm
Pin1	Pin1 Quadrant	<input checked="" type="checkbox"/> Q1 <input type="checkbox"/> Q2 <input type="checkbox"/> Q3 <input type="checkbox"/> Q4