

EM7028 Datasheet

Heart Rate Sensor with I²C Interface

Revision V 1.0

2016-05-03 Updated

CONTENTS

1. Description	6
2. Features	6
3. Functional Block Diagram.....	7
4. PIN Configuration	8
5. Functional Description	8
5.1 HRS in continuous mode.....	8
5.2 HRS in pulse mode.....	9
5.3 Typical performance chart.....	9
6. Parameters.....	10
7. Spectral Response Range.....	12
8. Absolute Maximum Ratings	12
9. I ² C State Machine.....	13
10. Timing	13
11. Registers Operation.....	14
12. Registers Definition	14
13. Sample Application.....	20
14. PCB Design.....	21
15. Package Outline Dimensions.....	22

16.	Packing	24
17.	Recommended Reflow Profile	25

FIGURE LIST

Fig. 1 EM7028 Functional Block Diagram	7
Fig. 2 EM7028 HRS value vs. receiving light lux	9
Fig. 3 EM7028 HRS wave.....	9
Fig. 4 Operation current vs. supply voltage in continuous mode w/o current-limiting resistor, and the current is controlled by VDD_LED and current-limiting resistor. Typical operation current for heart rate detection is around 1mA.	10
Fig. 5 Operation current vs. supply voltage in pulse mode w/i current controlled by resistors.	10
Fig. 6 LED1/LED2 Spectral Response Range (The peak wavelength may change without notification)	12
Fig. 7 Slave State Machine.....	13
Fig. 8 Data Structure.....	13
Fig. 9 Write waveform.....	13
Fig. 10 Read waveform	14
Fig. 11 Register random write operation	14
Fig. 12 Register page write operation	14
Fig. 13 Register random read operation.....	14
Fig. 14 Typical Application Circuit in pulse mode of HRS2 ((VDD 2.6~3.6V, VDD_I ² C 1.6~3.6V, VDD_LED 2.6~4.5V).....	20
Fig. 15 Typical Application Circuit in continuous mode of HRS1.....	21
Fig. 16 PCB layout design guide (all linear dimensions are in mm).....	22
Fig. 17 Side view of package	22
Fig. 18 Package Outline Dimensions	23
Fig. 19 Tape & Reel Information.....	24
Fig. 20 Recommended Reflow Profile for SMT	25

TABLE LIST

Table. 1 Pin Configuration	8
Table. 2 I ² C bus timing characteristics	10
Table. 3 Electrical Characteristics	11
Table. 4 Optical Characteristics	11
Table. 5 Absolute Maximum Ratings	12
Table. 6 REGISTER DESCRIPTION	15
Table. 7 REGISTER 0x00 (RESERVED)	15
Table. 8 REGISTER 0x01 (CONFIGURE) - PROX/HRS CONFIGURATION	15
Table. 9 REGISTER 0x02 (INTERRUPT) - PROX/GES/HRS INTERRUPT CONTROL	16
Table. 10 REGISTER 0x03 (HRS_LT) - INTERRUPT LOW THRESHOLD FOR HRS2/HRS1.....	16
Table. 11 REGISTER 0x04 (HRS_LT) - INTERRUPT LOW THRESHOLD FOR HRS2/HRS1 ...	16
Table. 12 REGISTER 0x05 (HRS_HT) - INTERRUPT LOW THRESHOLD FOR HRS2/HRS1...17	17
Table. 13 REGISTER 0x06 (HRS_HT) - INTERRUPT LOW THRESHOLD FOR HRS2/HRS1...17	17
Table. 14 REGISTER 0x07 (LED_CURRENT) – HRS2 LED CURRENT FOR HRS2.....	17
Table. 15 REGISTER 0x08 (HRS2_DATA_OFFSET) – HRS2 DATA OFFSET	17
Table. 16 REGISTER 0x09 (HRS2_CTRL) - HRS2 CONTROL	17
Table. 17 REGISTER 0x0A (HRS2_GAIN_CTRL) - PROXIMITY SENSOR GAIN CONTROL.....	18
Table. 18 REGISTER 0x0B (Reserved)	18
Table. 19 REGISTER 0x0C (Reserved)	18
Table. 20 REGISTER 0x0D (HRS1_CTRL) – HRS1 CONTROL.....	18
Table. 21 REGISTER 0x0E (INT_CTRL) –INTERRUPT CONTROL	19

1. Description

EM7028 is a low-power I²C interface module includes Heart Rate Sensor(HRS) and internal LED Current Drivers with 2 Green LED. It can work in both continuous mode and pulse mode. It is designed for applications of Heart Beat Rate detection esp. such as smart watch etc.

Heart Rate Sensor in continuous mode is designed to monitor heart rate by optical detection. A 16-bit ADC detects the result constantly with adjustable gain and resolution.

Heart Rate Sensor in pulse mode is designed to monitor heart rate by optical detection in low-power. It also acts as a proximity sensor with rejection of ambient light noise. In order to removing component variations and eliminate offset caused by IR reflection, 2 registers were specially defined for compensation and high dynamic range of detection.

HRS in continuous mode stores ADC output result into HRS1 registers, while HRS in pulse mode stores ADC output result into HRS2 registers. All pixels are controlled by analog-MUX in different modes.

2. Features

- Heart-Rate Sensors(HRS) with built-in 2 LED of 525nm wavelength integrated in a single Optical Module
- 50Hz/60Hz Flicker Noise Rejection
- Temperature Compensation
- Higher Sensitivity of Proximity Sensing
- HRS in continuous mode with higher detection rate
- HRS in pulse mode with Ambient Light Rejection
- HRS detect rates is up to 1000/s
- 2048 Steps Programmable LED current driver for flexibility and part-to-part calibration
- 16bits ADC of Heart Rate Sensor
- Offset register adjustment for compensation of DC noise
- Programmable Interrupt modes
- Low Average Operation Power consumption
- Output Type: I²C Bus (HRS2) up to 400K Hz
- Operation Voltage 2.5V ~ 3.6V
- Logic Interface Voltage VBUS=1.8V or VBUS=VDD
- Minimum External Components
- Package: (4.0mmX2.4mmX1.35mm)
- RoHS package

3. Functional Block Diagram

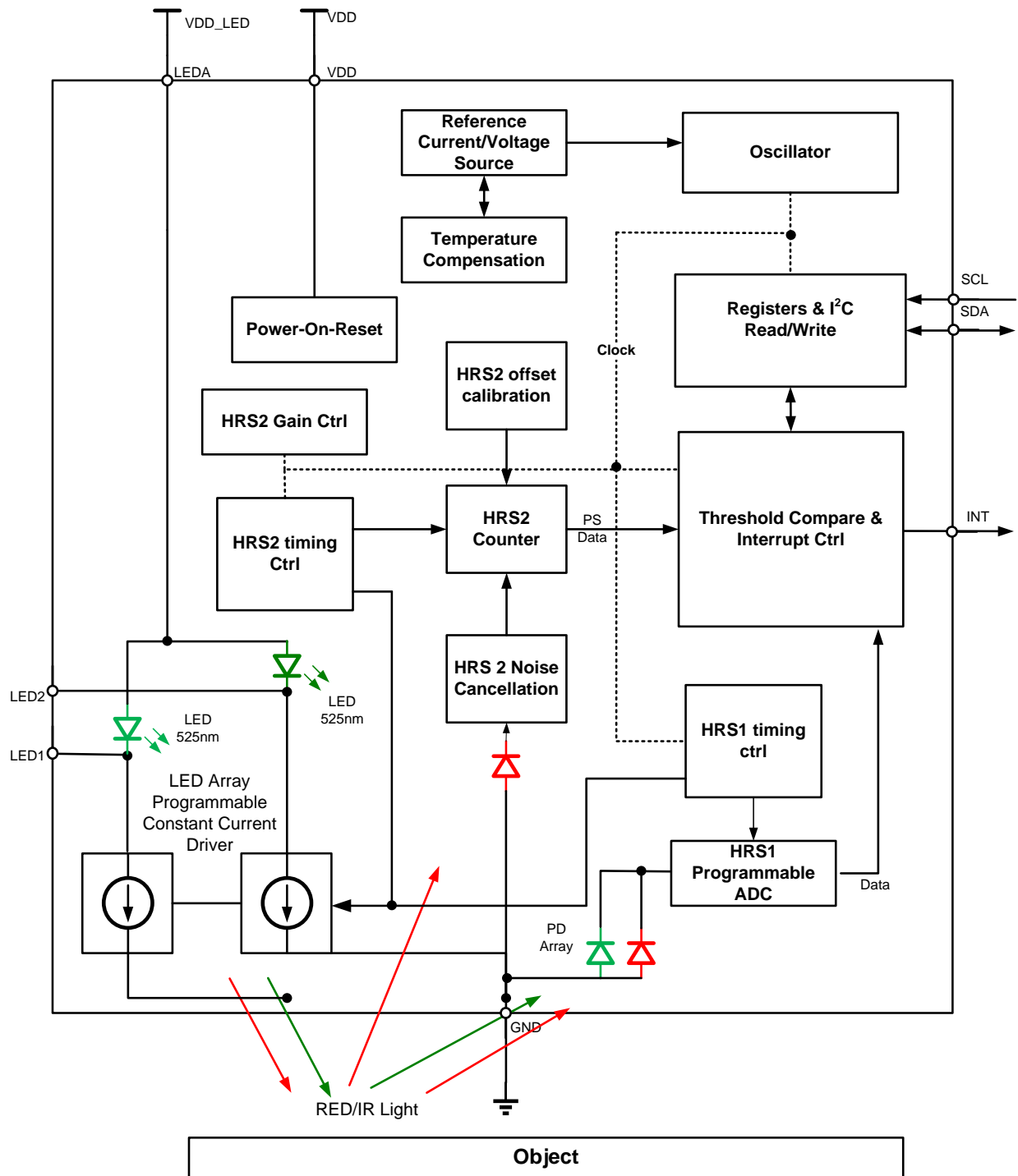

Fig. 1 EM7028 Functional Block Diagram

4. PIN Configuration

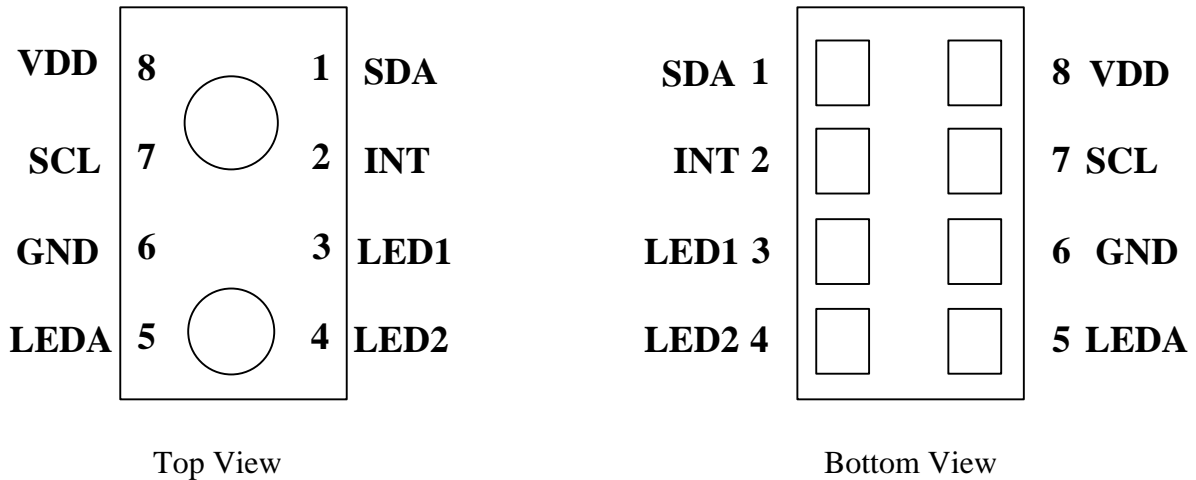

Table. 1 Pin Configuration

Pin No.	Pin Name	Type	Description
1	SDA	I/O(Open Drain)	I ² C Serial data I/O terminal -serial data I/O for I ² C
2	INT	O(Open Drain)	Interrupt.
3	LED1	O(Open Drain)	LED Current Driver for LED1 - up to 200mA
4	LED2	O(Open Drain)	LED Current Driver for LED2 - up to 12mA
5	LEDA	I	LED Anode, connect to VDD_LED on PCB
6	GND		Power supply ground. All voltages are referenced to GND
7	SCL	I(Open Drain)	I ² C serial clock input terminal — clock signal for I ² C serial data.
8	VDD		Power Supply voltage

5. Functional Description

5.1 HRS in continuous mode

In Normal HRS mode, one of the LED turns on, and HRS Sensor detects both ambient light and light from green LED. The sensitivity of light is 1 lux/count, and totally 65536lux in full range; The typical resolution of ADC is 16bits and 25ms conversion time.

In low-lux mode, 8 times of ADC gain is chosen for receiving light. The detect range is 0.125lux to 8192lux.

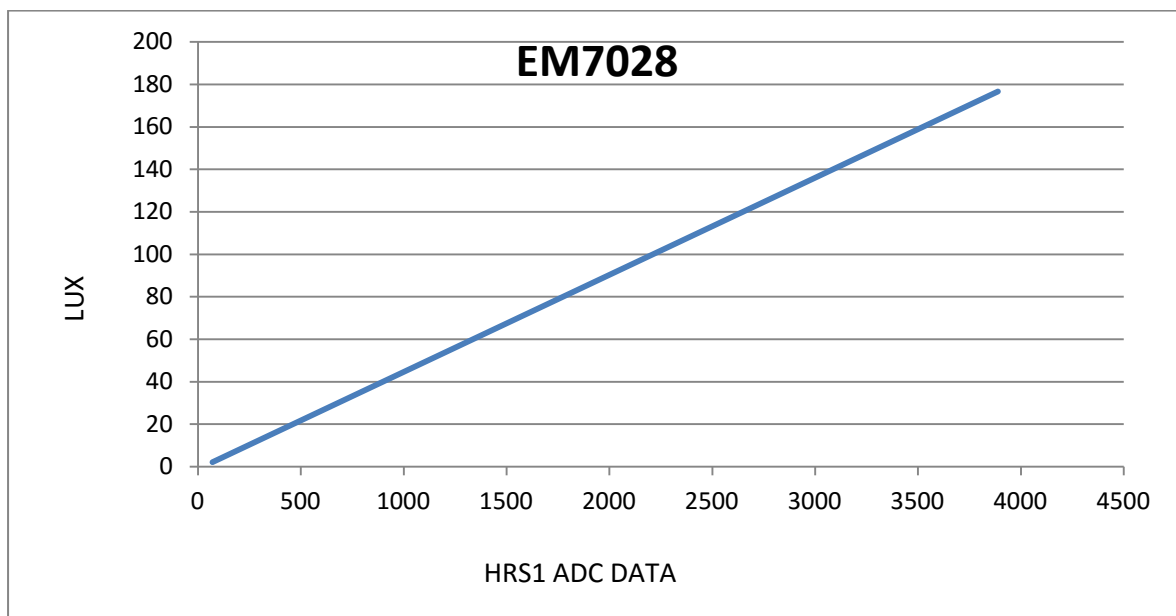

Fig. 2 EM7028 HRS value vs. receiving light lux

5.2 HRS in pulse mode

The Heart Rate Sensor in pulse mode detects reflected light with LED turned on in pulse.

5.3 Typical performance chart

HRS value typically reflect heart beat status as illustrated in Fig.3

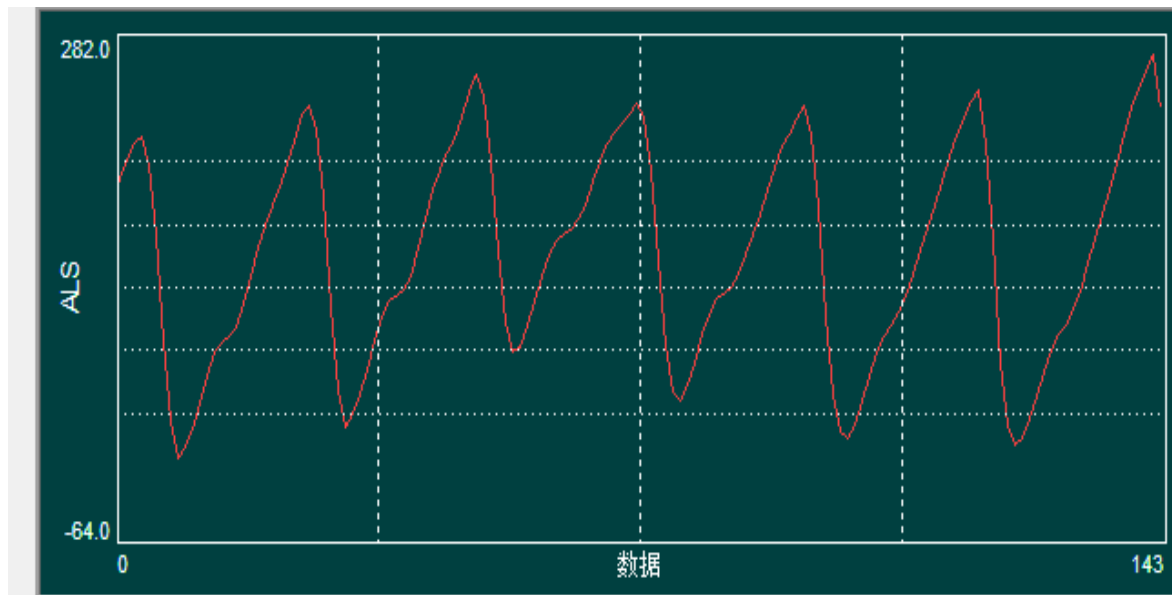

Fig. 3 EM7028 HRS wave

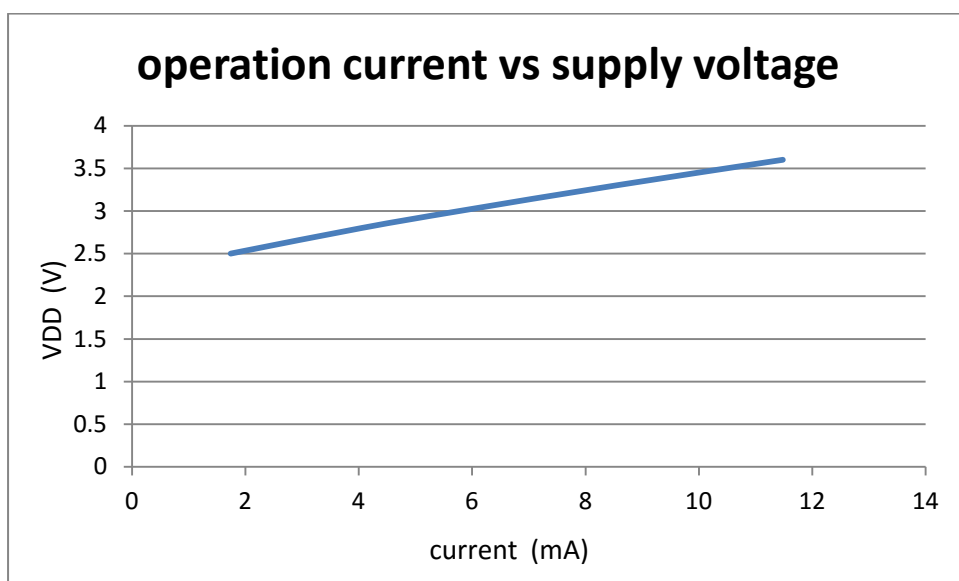

Fig. 4 Operation current vs. supply voltage in continuous mode w/o current-limiting resistor, and the current is controlled by VDD_LED and current-limiting resistor. Typical operation current for heart rate detection is around 1mA.

TBD

Fig. 5 Operation current vs. supply voltage in pulse mode w/i current controlled by resistors.

6. Parameters

Table. 2 I²C bus timing characteristics

Symbol	Parameters	Minimum	Typical	Maximum	Units	Condition
f _{clk}	SCL clock frequency	10k		100k	Hz	Normal Mode
		10k		400k	Hz	Fast Mode
t _{SUDAT}	data set up time	250			ns	Normal Mode
		100			ns	Fast Mode
t _{HDDAT}	data hold time			300	ns	Normal Mode
				90	ns	Fast Mode
t _{rise}	clock/data rise time			1000	ns	Normal Mode
				300	ns	Fast Mode
t _{fall}	clock/data fall time			300	ns	Normal Mode
				300	ns	Fast Mode
t _{LOW}	I ² C clock (SCL) low cycle	4.7			μs	Normal Mode
		1.3			μs	Fast Mode
t _{HIGH}	I ² C clock (SCL) high cycle	4.0			μs	Normal Mode
		0.6			μs	Fast Mode
t _{BUF}	Bus free time between the start and stop state	4.7			μs	Normal Mode
		1.3			μs	Fast Mode
t _{HDSTA}	(repeat) started state holding time	4.0			μs	Normal Mode

	after this period produce the first clock	0.6			μs	Fast Mode
t _{SUSTA}	Repeat the start state set up time	4.7			μs	Normal Mode
		0.6			μs	Fast Mode
t _{SUSTO}	Stop state set up time	4.0			μs	Normal Mode
		0.6			μs	Fast Mode
t _{TIMEOUT}	Low detection clock/data timeout time	25	35		ms	Normal Mode
					ms	Fast Mode
C _{load}	The capacitive load for each bus line			400	pF	
R _{BUS}	Pull up resistors SDA and SCL system bus	1		-	KΩ	
t _{VD}	Data valid time			0.9	μs	
t _{VDACK}	Data valid acknowledge time			0.9	μs	

Table. 3 Electrical Characteristics

Symbol	Min	Typ	Max	Units	Introductions
V _{DD}	2.6		3.6	V	Supply voltage
I _{DD}				μA	DC power supply current (with LED turned off)
V _{DD_I²C}	1.6		3.6	V	I ² C power supply voltage
V _{DD_LED}	2.6		4.5	V	LED power supply voltage
I _{DD_SD}				nA	Shut Down Current
T _A	-40		85	°C	Recommended operating temperature
V _{IL}			0.54	V	SCL/SDA Input low voltage
V _{IH}	1.25			V	SCL/SDA Input high voltage

Table. 4 Optical Characteristics

Parameters	Min	Typ	Max	Units	Descriptions (T _a = +25 °C)
Full scale HRS1 ADC count value			65536	counts	HRS register maximum count in continuous mode
HRS detect range			65536	lux	HRS detection range
Full scale HRS2 ADC count value			65536	counts	HRS ADC maximum count in pulse mode

HRS2 LED drive	2.5		200	mA	HRS2 LED drive current
HRS2 LED duty cycle		1/500			LED duty cycle, cycle of HRS2 at 100 ms
V _F			TBD	V	LED Forward Voltage, I _F =20 mA
V _R				V	LED Reverse Voltage, I _R =1 μA
P _O	0.8			mW	LED Radiant Power, I _F =20 mA
λ _p		525		nm	LED Peak Wavelength, I _F =100 mA
Δλ		30		nm	Spectrum Width of Half Value, I _F =20 mA
T _R				ns	LED Optical Rise Time, I _F =20 mA
T _F				ns	LED Optical Fall Time, I _F =20 mA

7. Spectral Response Range

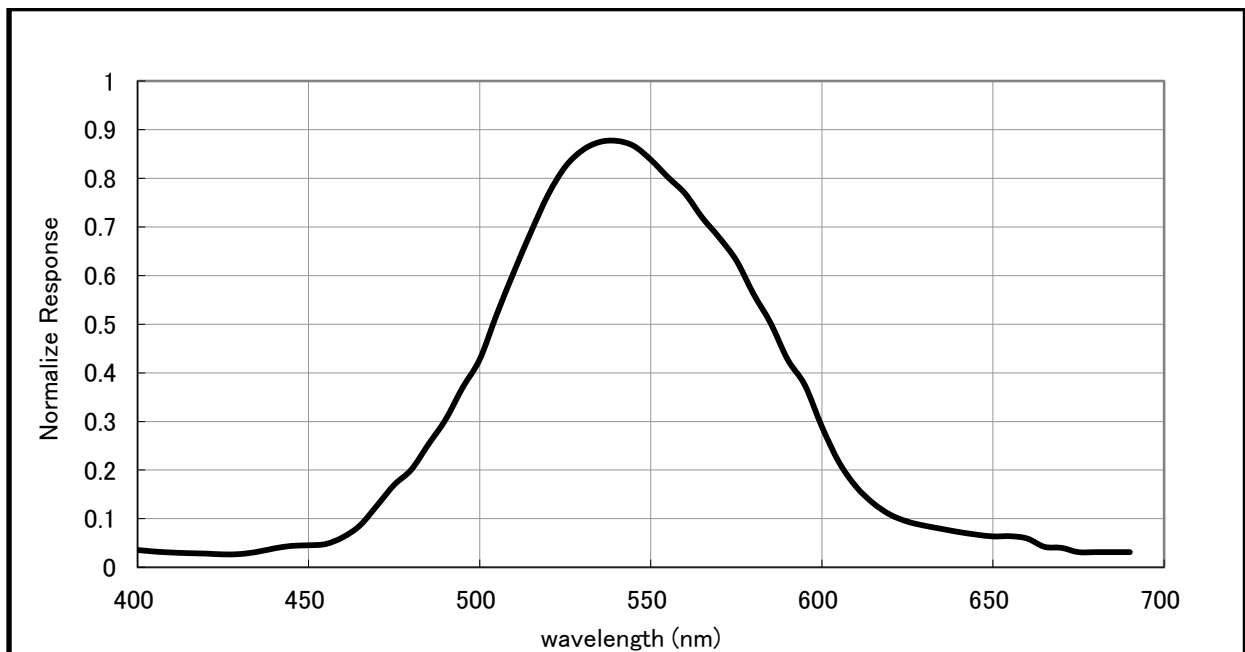

Fig. 6 LED1/LED2 Spectral Response Range (The peak wavelength may change without notification)

LED2 has the same spectral response as LED1

8. Absolute Maximum Ratings

Table. 5 Absolute Maximum Ratings

Parameters	Symbol	Min.	Max.	Units	Condition
Storage Temperature	T _S	-40	85	°C	
Operation Temperature	T _A	-40	85	°C	
Supply Voltage	V _{DD}	2.25	3.6	V	

ESD	V _{ESD}	2K		V	HBM
ESD	V _{ESD}	200		V	MM

9. I²C State Machine

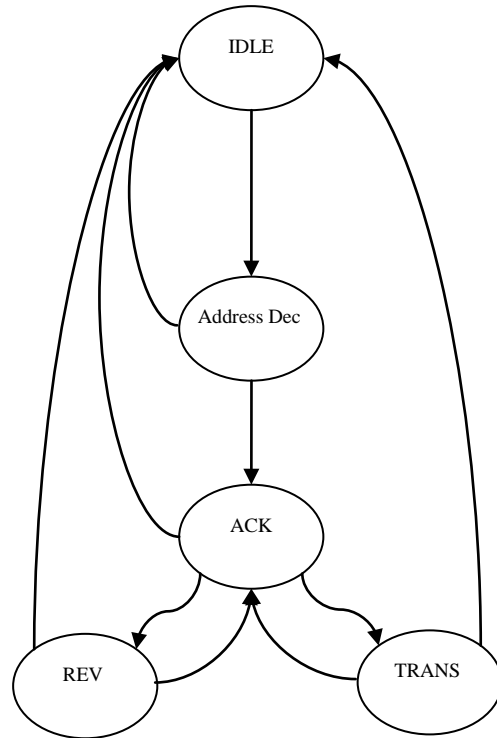

Fig. 7 Slave State Machine

10. Timing

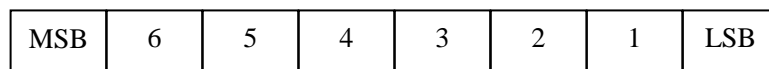

Fig. 8 Data Structure

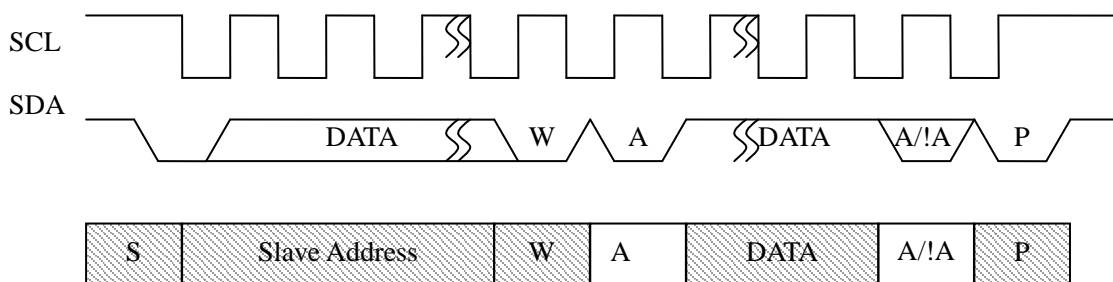

Fig. 9 Write waveform

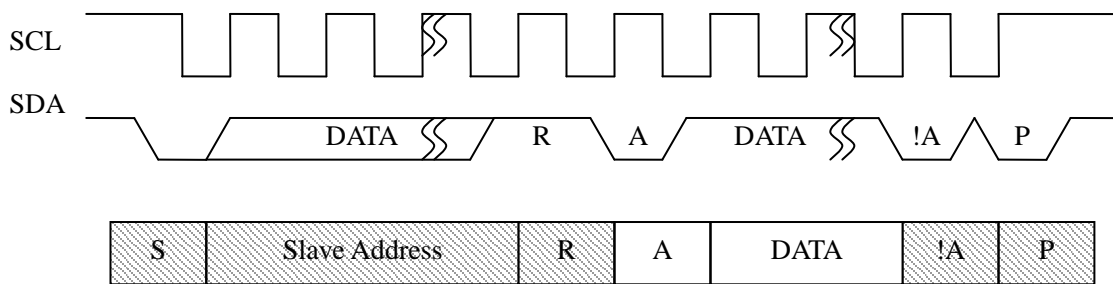

Fig. 10 Read waveform

11. Registers Operation



Fig. 11 Register random write operation

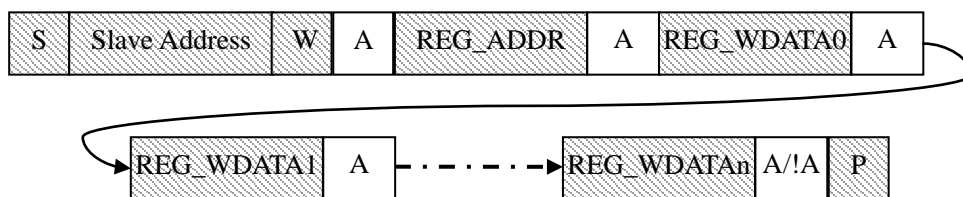

Fig. 12 Register page write operation

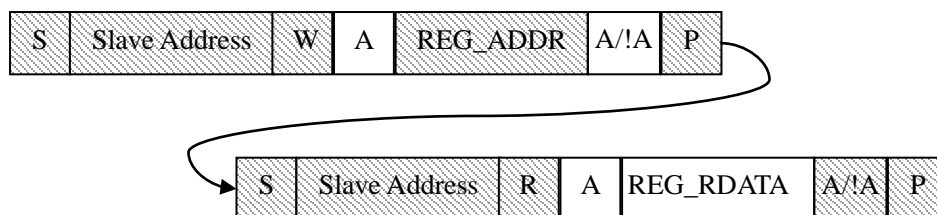

Fig. 13 Register random read operation

12. Registers Definition

Function Modes:

1. HRS1 (Heart Rate Measurement in Continuous Mode)
2. HRS2 (Heart Rate Measurement in Pulse Mode)

Table. 6 REGISTER DESCRIPTION

Address	R/W	Bit7	Bit 6	Bit 5	Bit 4	Bit 3	Bit 2	Bit 1	Bit 0	Default
0(0x00)	R	PID								0x36
1(0x01)	R/W	HRS2_EN	Reserved	Reserved	Reserved	HRS1_EN	Reserved	Reserved	Reserved	0x00
2(0x02)	R/W	HRS2_FLAG	HRS2_PRST[1:0]		Reserved	HRS1_FLAG	HRS1_PRST[1:0]		INT_CTRL	0x00
3(0x03)	R/W	HRS_LT[7:0]								0x00
4(0x04)	R/W	HRS_LT[15:8]								0x00
5(0x05)	R/W	HRS_HT[7:0]								0xFF
6(0x06)	R/W	HRS_HT[15:8]								0xFF
7(0x07)	R/W	LED_CAL[7:0]								0x80
8(0x08)	R/W	HRS2_DATA_OFFSET[7:0]								0x00
9(0x09)	R/W	Reserved	HRS2_TIME[2]	HRS2_TIME[1]	HRS2_TIME[0]	LED_WIDTH[1]	LED_WIDTH[0]	LED_CNT[1]	LED_CNT[0]	0x40
10(0x0A)	R/W	HRS2_GAIN	HRS2_POS[6]	HRS2_POS[5]	HRS2_POS[4]	HRS2_POS[3]	HRS2_POS[2]	HRS2_POS[1]	HRS2_POS[0]	0x01
11(0x0B)	R	SIGN	Reserved							0x00
12(0x0C)	R	SIGN	Reserved							0x00
13(0x0D)	R/W	HRS_GAIN	HRS_RANGE	HRS_FREQ[2:0], 40960Hz to 2.62144MHz			HRS_RES[1:0], 10b, 12b, 14b, 16b		IR_MODE	0x32
14(0x0E)	R/W	INT_EN	INT_MODE1	INT_MODE2	INT_MODE3	Reserved	HRS2_DR[2:0], Programmed LED Current			0x90
15(0x0F)	R/W	SOFT_RESET[7:0]								0x00
32(0x20)	R	HRS2_DATA0[7:0]								0x00
33(0x21)	R	HRS2_DATA0[15:8]								0x00
34(0x22)	R	HRS2_DATA1[7:0]								0x00
35(0x23)	R	HRS2_DATA1[15:8]								0x00
36(0x24)	R	HRS21_DATA2[7:0]								0x00
37(0x25)	R	HRS2_DATA2[15:8]								0x00
38(0x26)	R	HRS2_DATA3[7:0]								0x00
39(0x27)	R	HRS2_DATA3[15:8]								0x00
40(0x28)	R	HRS1_DATA0[7:0]								0x00
41(0x29)	R	HRS1_DATA0[15:8]								0x00
42(0x2A)	R	HRS1_DATA1[7:0]								0x00
43(0x2B)	R	HRS1_DATA1[15:8]								0x00
44(0x2C)	R	HRS1_DATA2[7:0]								0x00
45(0x2D)	R	HRS1_DATA2[15:8]								0x00
46(0x2E)	R	HRS1_DATA3[7:0]								0x00
47(0x2F)	R	HRS1_DATA3[15:8]								0x00
48(0x30)	R	HRS1_DATA0[7:0]								0x00
49(0x31)	R	HRS1_DATA0[15:8]								0x00

Table. 7 REGISTER 0x00 (RESERVED)

BIT #	ACCESS	Default	Name	FUNCTION/OPERATION
7:0	RO	0x36	PID	Product ID - readable

Table. 8 REGISTER 0x01 (CONFIGURE) - PROX/HRS CONFIGURATION

BIT#	R/W	Default Value	Name	Name/operation description
7	RW	0	HRS2_EN	When= 0, heart rate sensing in pulse mode is disabled; When= 1, heart rate sensing in pulse mode is enabled; The enabled HRS2 pixels are defined by HRS2_POS, and HRS2 ADC gain is defined by HRS2_GAIN;
6	RW	0	Reserved	Reserved
5	RW	0	Reserved	Reserved

4	RW	0	Reserved	Reserved
3	RW	0	HRS1_EN	When= 0, Heart Beat Measurement is disabled; When= 1, Heart Beat Measurement is enabled with LED1 turned on and only Red Light Sensor and IR sensor enabled. When LED1 turned on, the result stores to HRS_DATA0;
2	RW	1	Reserved	Reserved
1	RW	1	Reserved	Reserved
0	RW	1	Reserved	Reserved

Only one of HRS1/HRS2 modes is enabled in a time

Table. 9 REGISTER 0x02 (INTERRUPT) - PROX/GES/HRS INTERRUPT CONTROL

BIT #	ACCESS	Default	BIT Name	Function/Operation
7	FLAG	0	HRS2_FLAG	When=0, no proximity interrupt event has occurred since power-on or last “clear” When=1, a proximity interrupt event occurred. Clearable by writing “0”
6 : 5	RW	00	HRS2 Persist	When=00, 1 times of HRS2 value transfer threshold value; When=01, 2 times of HRS2 value transfer threshold value; When=10, 4 times of HRS2 value transfer threshold value; When=11, 8 times of HRS2 value transfer threshold value;
4	FLAG	0	Reserved	Reserved
3	FLAG	0	HRS1_FLAG	When=0, no HRS1 interrupt event has occurred since power-on or last “clear” ; When=1, an HRS1 interrupt event occurred. Clearable by writing “0”
2:1	RW	00	HRS1 Persist	When=00, 1 times of HRS1 value transfer threshold value; When=01, 2 times of HRS1 value transfer threshold value; When=10, 4 times of HRS1 value transfer threshold value; When=11, 8 times of HRS1 value transfer threshold value;
0	RW	0	INT_CTRL	When=0, only HRS2 interrupt is enabled, unless INT_EN=0; When=1, only HRS interrupt is enabled, unless INT_EN=0;

Table. 10 REGISTER 0x03 (HRS_LT) - INTERRUPT LOW THRESHOLD FOR HRS2/HRS1

BIT #	ACCESS	Default	BIT Name	Function/operation
7:0	RW	0x00	HRS_LT (HRS2/HRS1 Low Threshold)	Low 8-bit interrupt low threshold for HRS sensing.

Table. 11 REGISTER 0x04 (HRS_LT) - INTERRUPT LOW THRESHOLD FOR HRS2/HRS1

BIT #	ACCESS	Default	BIT Name	Function/operation
7:0	RW	0x00	HRS_LT	High 8-bit interrupt low threshold for HRS sensing.

			(HRS2/HRS1 Low Threshold)	
--	--	--	------------------------------	--

Table. 12 REGISTER 0x05 (HRS_HT) - INTERRUPT LOW THRESHOLD FOR HRS2/HRS1

BIT #	ACCESS	Default	BIT Name	Function/operation
7:0	RW	0xFF	HRS_HT (HRS2/HRS1 High Threshold)	Low 8-bit interrupt high threshold for HRS sensing.

Table. 13 REGISTER 0x06 (HRS_HT) - INTERRUPT LOW THRESHOLD FOR HRS2/HRS1

BIT #	ACCESS	Default	BIT Name	Function/operation
7:0	RW	0xFF	HRS_HT (HRS2/HRS1 High Threshold)	High 8-bit interrupt high threshold for HRS sensing.

Table. 14 REGISTER 0x07 (LED_CURRENT) – HRS2 LED CURRENT FOR HRS2

BIT #	ACCESS	Default	BIT Name	Function/operation
7:0	RW	0x80	LED CAL	When=0x00, LED current is 256/512 of full range; When=0x01, LED current is 257/512 of full range; When=0x02, LED current is 258/512 of full range; ... When=0xff, LED current is of full range to maximum; This function serves for LED calibration;

Table. 15 REGISTER 0x08 (HRS2_DATA_OFFSET) – HRS2 DATA OFFSET

BIT #	ACCESS	Default	BIT Name	Function/operation
7	RW	0x0	Reserved	N/A
6:0	RW	0x00	HRS2_OFFSET	When=0x00, no offset; When=0x01, HRS2 data subtract by 8 counts(6.25n); When=0x02, HRS2 data subtract by 16 counts(12.5n); ... When=0x8f, HRS2 data subtract by 1016 counts (793.75n);

Table. 16 REGISTER 0x09 (HRS2_CTRL) - HRS2 CONTROL

BIT #	ACCESS	Default	BIT Name	Function/operation
7	RW	0x0	Reserved	When=0, HRS2 conversion is continuous; When=1, HRS2 conversion is divided by WAIT time specified in HRS2_TIME;
6:4	RW	0b100	HRS2_WAIT_TIME	When=000, HRS2 WAIT TIME = 0, continuous detect; When=001, HRS2 WAIT TIME = 1.5625ms.;

				When=010, HRS2 WAIT TIME = 6.25ms; When=011, HRS2 WAIT TIME = 25ms; When=100, HRS2 WAIT TIME = 100ms; When=101, HRS2 WAIT TIME =400ms ; When=110, HRS2 WAIT TIME = 1.6s; When=111, HRS2 WAIT TIME = 6.4s;
3:2	RW	0b10	LED_WIDTH	When=00, LED WIDTH = 8 counts; When=01, LED WIDTH = 32 counts; When=10, LED WIDTH = 128 counts; When=11, LED WIDTH = 512 counts;
1:0	RW	0b00	LED_CNT	When=00, LED COUNT = 1; When=01, LED COUNT =4; When=10, LED COUNT = 16; When=11, LED COUNT = 64;

Table. 17 REGISTER 0x0A (HRS2_GAIN_CTRL) - PROXIMITY SENSOR GAIN CONTROL

BIT #	ACCESS	Default	BIT Name	Function/operation
7	RW	0b0	HRS2_GAIN	When=0, HRS2 GAIN = 1; When=1, HRS2 GAIN = 10;
6:0	RW	0x01	HRS2_POS[6:0]	Each bit mark one pixel;

Table. 18 REGISTER 0x0B (Reserved)
Table. 19 REGISTER 0x0C (Reserved)
Table. 20 REGISTER 0x0D (HRS1_CTRL) – HRS1 CONTROL

BIT #	ACCESS	Default	BIT Name	Function/operation
7	RW	0x1	HRS_GAIN	When = 0, HRS1 GAIN =1; When =1, HRS1 GAIN =5::
6	RW	0x1	HRS_RANGE	When = 0, HRS1 RANGE =1; When =1, HRS1 RANGE =8;
5:3	RW	0b110	HRS_FREQ	When=000, HRS1 FREQ = 2.62144MHz (1.5625ms); When=001, HRS1 FREQ = 1.31072MHz(3.125 ms); When=010, HRS1 FREQ = 655,360Hz(6.25 ms); When=011, HRS1 FREQ = 327,680Hz(12.5ms); When=100, HRS1 FREQ = 163,840Hz(25ms); When=101, HRS1 FREQ = 81,920Hz(50ms); When=110, HRS1 FREQ = 40,960Hz(100ms); When=111, HRS1 FREQ = 20,480Hz(200ms) ;
2:1	RW	0b01	HRS_RES	When=00, HRS1 RES = 10 bits; When=01, HRS1 RES = 12 bits; When=10, HRS1 RES = 14 bits;

				When=11, HRS1 RES = 16 bits;
0	RW	0b1	IR_MODE	When=0, IR mode; When=1, HRS1 mode;

Table. 21 REGISTER 0x0E (INT_CTRL) –INTERRUPT CONTROL

BIT #	ACCESS	Default	BIT Name	Function/operation
7	RW	0b1	INT_EN	When=1, INT mode is enabled
6	RW	0b0	INT_MODE1	When=0, INT_MODE1 is disabled; When=1, INT pin is drive “low” and interrupt flag is set to “1” when register value up transfer the high threshold, and INT pin is pulled “high” and interrupt flag reset “0” when register value down transfer the low threshold.
5	RW	0b0	INT_MODE2	When=0, INT_MODE2 is disabled; When=1, INT pin is drive “low” and interrupt flag is set to “1” when register value larger than the high threshold, and INT pin is pulled “high” and interrupt flag reset “0” when register value is lower than the low threshold.
4	RW	0b1	INT_MODE3	When=0, INT_MODE3 is disabled; When=1, INT pin is drive “low” and interrupt flag is set to “1” when register value is larger than the high threshold or lower than the low threshold, otherwise INT pin is pulled “high” and interrupt flag reset “0” .
3	RW	0b0	Reserved	Reserved
2:0	RW	0b000	HRS2_DR[2:0]	Peak current for LED1 of IR light, the average current for LED1 is 1/500 of programmed current configured, while the internal duty cycle is 1/500 When=000, LED programmed current = 2.5mA; When=001, LED programmed current = 5.0mA; When=010, LED programmed current = 7.5mA; When=011, LED programmed current = 12.5mA; When=100, LED programmed current = 25mA; When=101, LED programmed current = 50mA; When=110, LED programmed current = 100mA; When=111, LED programmed current = 200mA;

Table. 22 REGISTER 0x0F (SOFT_RESET) – SOFT RESET BIT

Write any data to the SOFT_RESET register will reset the chip. No need to set a real register.

Table. 23 I²C Device address

operation	I ² C Device address								address
	7	6	5	4	3	2	1	0	
Write Register	0	1	0	0	1	0	0	0	0x48H
Read Register	0	1	0	0	1	0	0	1	0x49H

The I²C Interface and 7-bit slave address is 0x24.

13. Sample Application

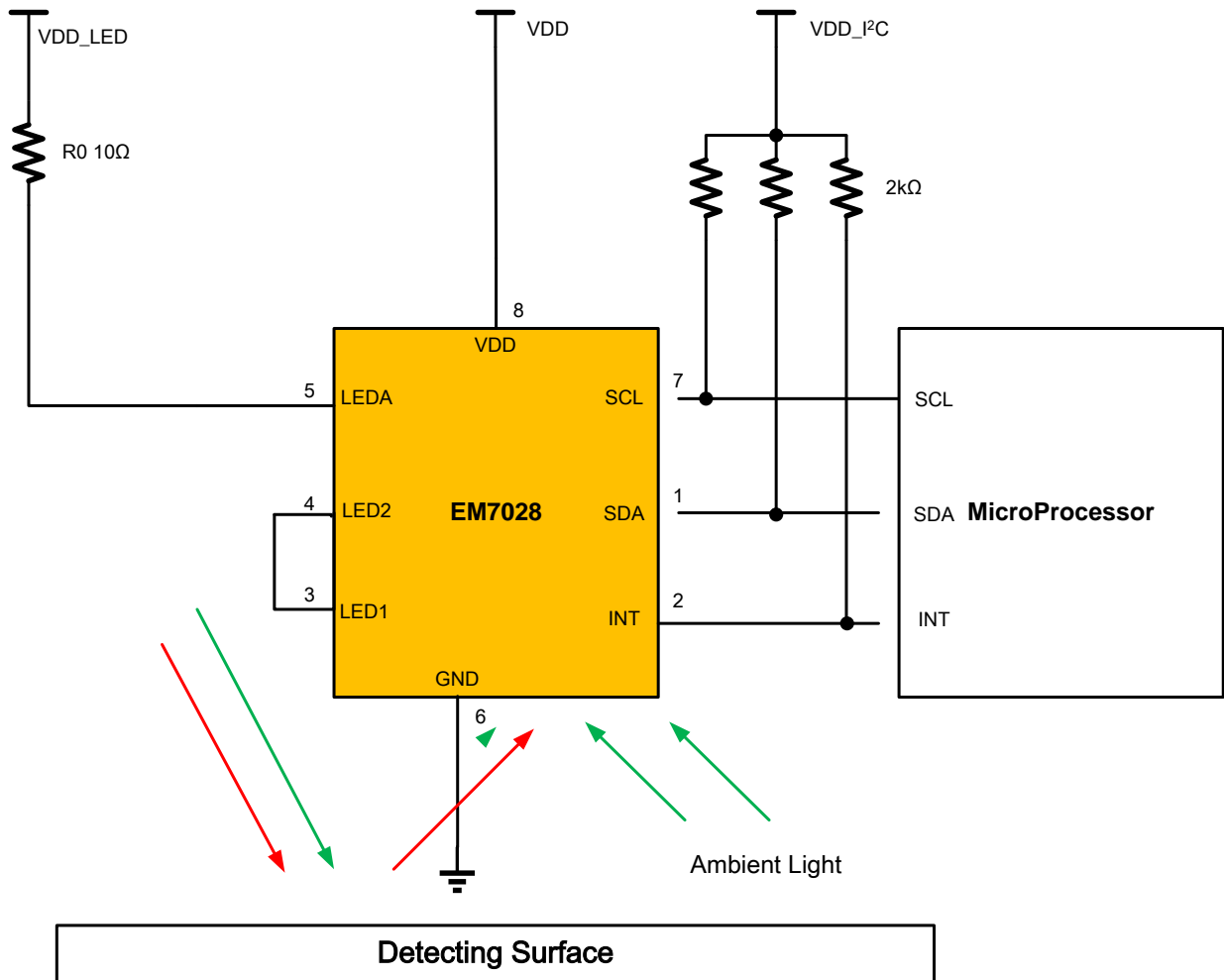

Fig. 14 Typical Application Circuit in pulse mode of HRS2 ((VDD 2.6~3.6V, VDD_I²C 1.6~3.6V, VDD_LED 2.6~4.5V)

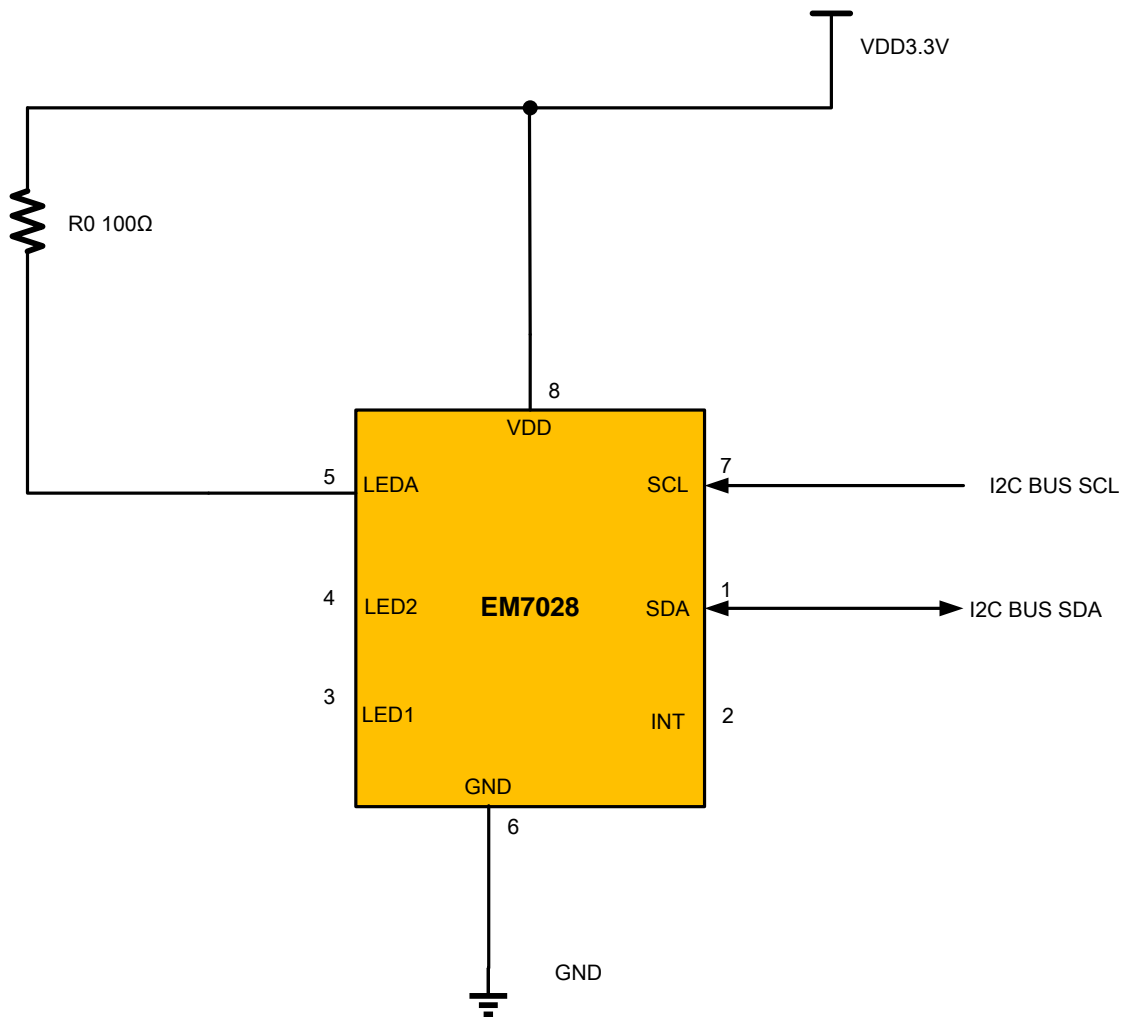

Fig. 15 Typical Application Circuit in continuous mode of HRS1

VDD, VDD_I²C, VDD_LED can be connected together as VDD3.3V to 3.3V voltage.

VDD3.3V should connect 0.1uF capacitor to ground.

INT can be disconnected if no need of interrupt mode.

R₀ is LED2 adjust resistor, and the typical value of R₀ is 100Ω.

14.PCB Design

Suggested PCB pad layout guidelines for the Dual Flat No-Lead surface mount package are shown below.

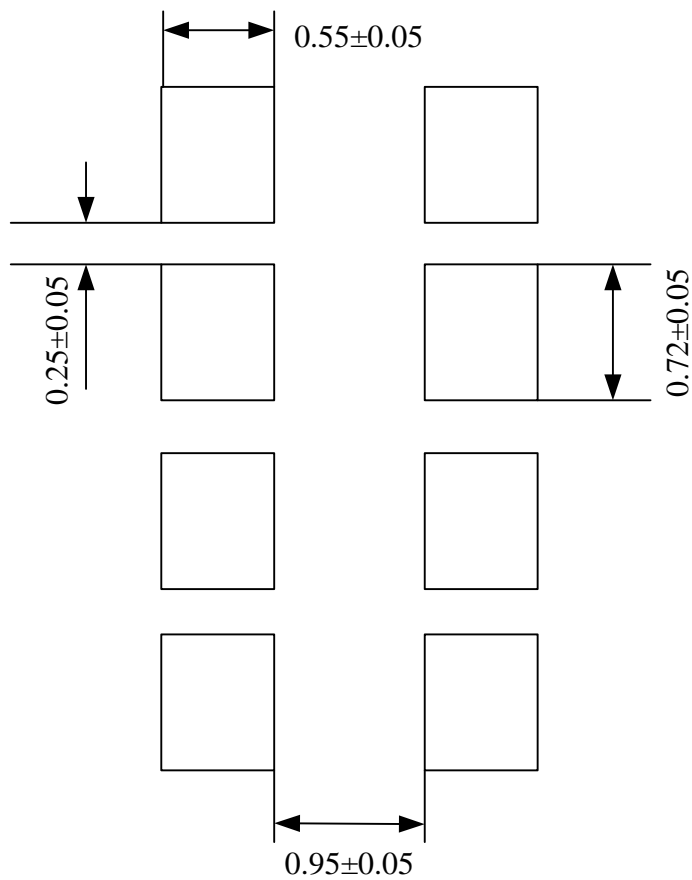

Fig. 16 PCB layout design guide (all linear dimensions are in mm)

15. Package Outline Dimensions

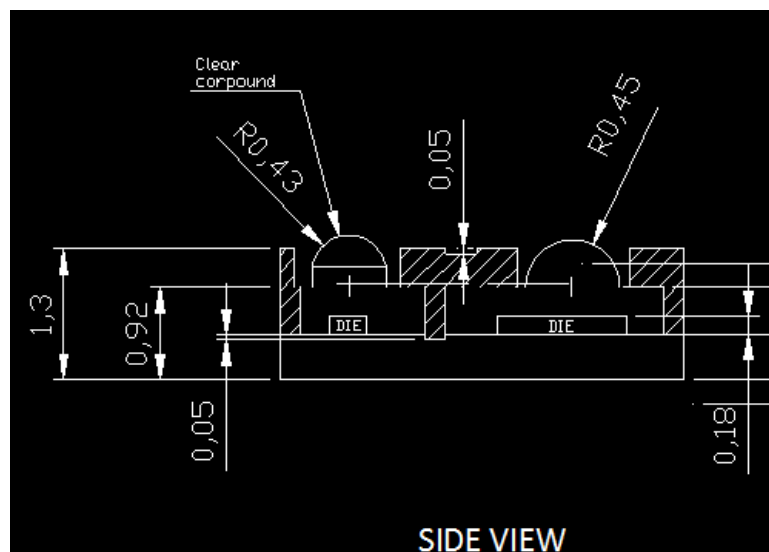

Fig. 17 Side view of package

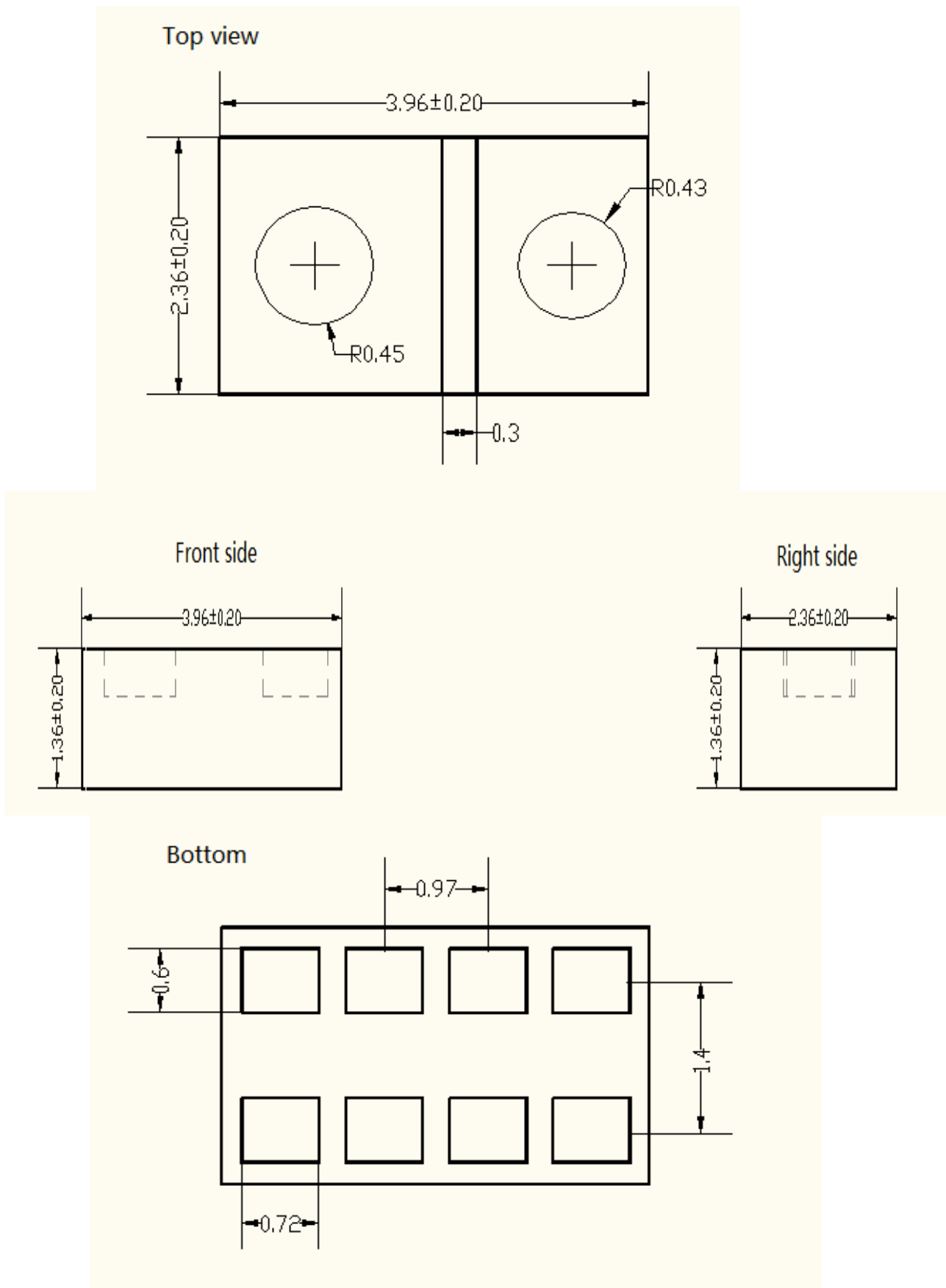
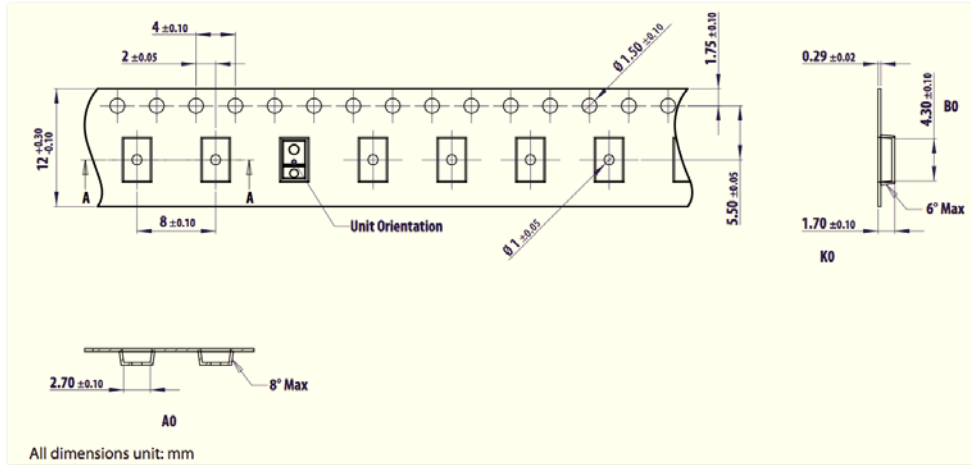

Fig. 18 Package Outline Dimensions

16. Packing

Tape and reel dimensions is compliant to JEDEC MSL 3



Ordering Information	Q'TY/REEL	Q'TY/inside box	Q'TY/outside box	Remark
EM7028 (7' reel)	1000EA	2000EA	20000EA	MBB/Label/Temperature Card/Silica gel

Fig. 19 Tape & Reel Information

17.Recommended Reflow Profile

PARAMETER	REFERENCE	DEVICE
Average temperature gradient in preheating		2.5°C/sec
Soak time	t_{soak}	2 to 3 minutes
Time above 217°C(T_1)	T_1	Max 60 sec
Time above 230°C(T_2)	T_2	Max 50 sec
Time above $T_{\text{peak}}-10^\circ\text{C}$ (T_3)	T_3	Max 10 sec
Peak temperature in reflow	T_{peak}	260°C
Temperature gradient in cooling		Max-5°C/sec

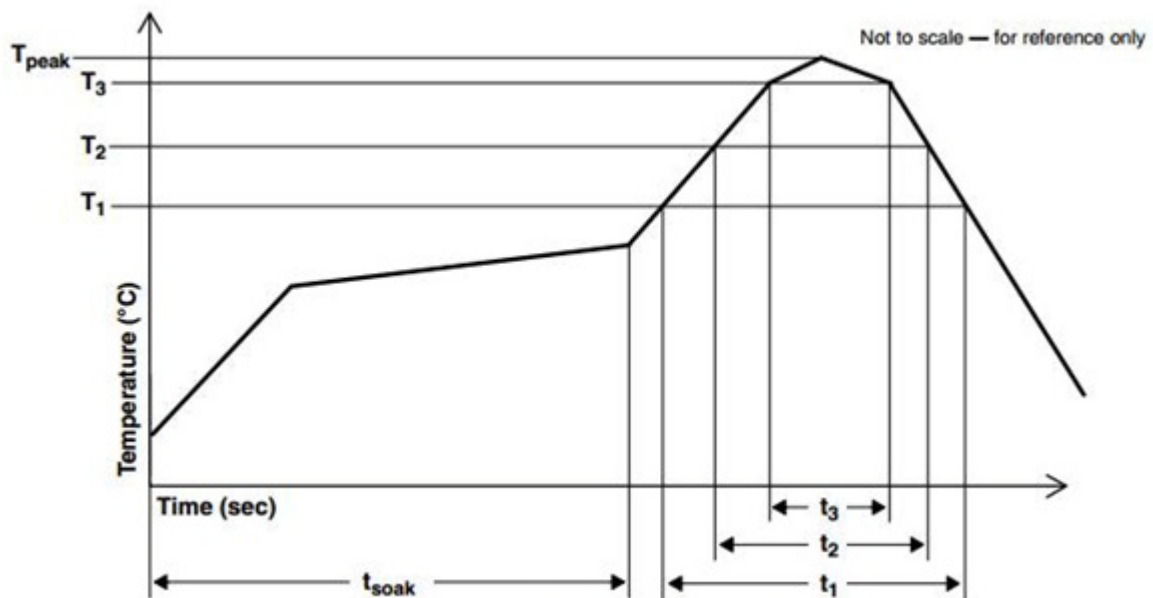
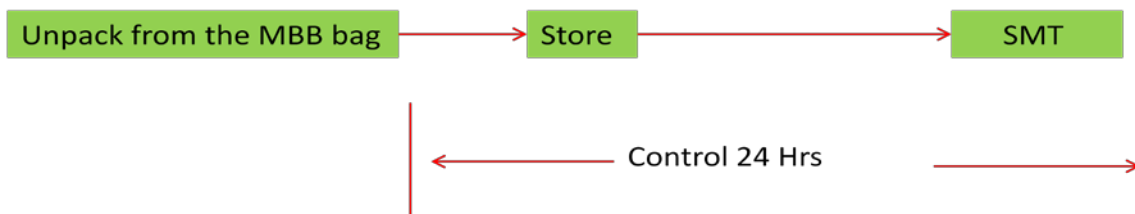

Fig. 20 Recommended Reflow Profile for SMT

The product require to control strictly to prevent moisture absorption into unit. The recommend control is as following. Rebaking of the reel will be required if the devices is unpack from the MBB bag more than 24 hours. If rebaking is required, it should be done at 50°C for 12 hours.



History

Date	Author	Modification

NOTICE:

- 1. The information here contained could be changed without notice owing to product and/or technical improvements. Please make sure before using the product that the information you are referring to is up-to-date.*
- 2. No responsibilities are assumed by us for any consequence resulting from any wrong or improper operation, etc. of the product.*

Epticore Microelectronics Co. Ltd.

For product information and a complete list of distributors, please contact sales@epticore.com or go to our web site:
<http://www.epticore.com>

Copyright © 2016 by Epticore Microelectronics

The information appearing in this Data Sheet is believed to be accurate at the time of publication. However, Epticore Microelectronics assumes no responsibility arising from the using of the specification described. The applications mentioned herein are used solely for the purpose of illustration and Epticore Microelectronics makes no warranty or representation that such application will be suitable without further modification, nor recommends the use of its product for application that may present a risk to human life due to malfunction or otherwise. Epticore Microelectronics reserves the right to alter its product without prior notification. For the most up-to-date information, please contact sales representatives.