

# **eMMC 8GB MKEV008GCB-SS510 Specification**

V1.0

Aug 13th, 2019

# Contents

1. Foreword .....	6
2. Revision History .....	7
3. Statement of Scope .....	8
4. General Description .....	9
4.1. Product list .....	9
4.2. Feature .....	9
5. eMMC Function Block Diagram .....	11
6. Pin Description .....	12
6.1. eMMC 153 Ball Pin Assignment .....	12
6.2. eMMC Pin Description .....	13
7. Electrical Characteristics .....	14
7.1. General operating conditions .....	14
7.2. Device Power Diagram .....	14
7.3. Power supply voltage .....	15
7.4. Bus Signal Line Loading .....	15
7.5. Bus Signal Level .....	16
7.6. Bus Timing for eMMC in backward-compatible device and high speed mode ...	17
7.7. Bus Timing for eMMC in DDR Mode .....	19
7.8. Bus Timing for eMMC in HS200 Mode .....	21
7.9. Bus Timing for eMMC in HS400 Mode .....	22
8. eMMC Register Description .....	25
8.1. Operation Conditions Register (OCR) Register .....	25

8.2.	SD Card Identification Register (CID) .....	26
8.3.	Driver Stage Register (DSR).....	26
8.4.	Relative Card Address Register (RCA) .....	26
8.5.	Card Specific Data Register (CSD).....	26
8.6.	Extended CSD register .....	28
9.	Production Specifications.....	39
9.1.	Performance .....	39
9.2.	Power Consumption .....	39
9.3.	Endurance Test.....	40
9.3.1	Bit Test.....	40
9.3.2	Junior Test.....	40
10.	Package Dimension .....	41
11.	MKEV008GCB-SS510 Compatibility List .....	42
12.	MKEV008GCB-SS510 Partition Configuration.....	44

## List of Figures

FIGURE 5-1 EMMC FUNCTION BLOCK DIAGRAM.....	11
FIGURE 6-1 EMMC 153 BALL PIN ASSIGNMENT (TOP VIEW) .....	12
FIGURE 7-1 DEVICE POWER DIAGRAM .....	14
FIGURE 7-2 BUS SIGNAL LEVEL .....	16
FIGURE 7-3 TIMING DIAGRAM DATA INPUT/OUTPUT REFERENCED TO CLOCK (EMMC IN BACKWARD-COMPATIBLE DEVICE AND HIGH SPEED) .....	17
FIGURE 7-4 TIMING DIAGRAM DATA INPUT/OUTPUT REFERENCED TO CLOCK (DDR MODE).....	19
FIGURE 7-5 TIMING DIAGRAM DATA INPUT REFERENCED TO CLOCK (HS200 MODE) ....	21
FIGURE 7-6 TIMING DIAGRAM DATA OUTPUT REFERENCED TO CLOCK (HS200 MODE) .	21
FIGURE 7-7 TIMING DIAGRAM DATA INPUT REFERENCED TO CLOCK (HS400 MODE) ....	22
FIGURE 7-8 TIMING DIAGRAM DATA OUTPUT REFERENCED TO CLOCK (HS400 MODE) .	23
FIGURE 10-1 PACKAGE OUTLINE DIMENSION DRAWING.....	41

# List of Table

TABLE 4-1 EMMC PRODUCT LIST.....	9
TABLE 6-1 EMMC PIN DESCRIPTION .....	13
TABLE 7-1 GENERAL OPERATING CONDITIONS.....	14
TABLE 7-2 POWER SUPPLY VOLTAGE .....	15
TABLE 7-3 BUS SIGNAL LINE LOADING .....	15
TABLE 7-4 BUS SIGNAL LINE LOADING FOR HS400 .....	16
TABLE 7-5 BUS SIGNAL LEVEL.....	17
TABLE 7-6 BACKWARD-COMPATIBLE DEVICE MODE TIMING FOR EMMC.....	18
TABLE 7-7 HIGH SPEED MODE TIMING FOR EMMC .....	18
TABLE 7-8 DDR MODE TIMING FOR EMMC.....	20
TABLE 7-9 HS200 MODE TIMING FOR EMMC .....	22
TABLE 7-10 HS400 MODE TIMING FOR EMMC.....	23
TABLE 8-1 EMMC REGISTER TABLE.....	25
TABLE 8-2 OCR TABLE .....	25
TABLE 8-3 CID TABLE .....	26
TABLE 8-4 CSD TABLE .....	27
TABLE 8-5 EXTEND CSD TABLE .....	28
TABLE 9-1 MKEV008GCB-SS510 PERFORMANCE .....	39
TABLE 9-2 MKEV008GCB-SS510 OPERATING CURRENT.....	39
TABLE 9-3 MKEV008GCB-SS510 STANDBY/SLEEP CURRENT.....	39
TABLE 9-4 MKEV008GCB-SS510 BIT TEST .....	40
TABLE 9-5 MKEV008GCB-SS510 JUNIOR TEST.....	40
TABLE 11-1 MKEV008GCB-SS510 COMPATIBILITY LIST.....	42
TABLE 12-1 MKEV008GCB-SS510 PARTITION CONFIGURARION TABLE.....	47

## 1. **Foreword**

This document has been produced by MKEV008GCB-SS510, should the company modifies the contents of this specification, it will be re-released with an identifying change of release date and an increase in revision number as follows:

Revision mn.xy, where:

- mn the first two digit are incremented for major changes of substance, e.g., functional changes.
- xy the second two digits are incremented when minor changes have been incorporated into the specification, i.e., enhancements, corrections, updates, etc.

[Top page](#)

## 2. Revision History

Revision	Date	Modified By	Description
1.0	2019/8/13	Angel Lin	Initial release

[Top page](#)

MK Confidential

### 3. Statement of Scope

This Datasheet document is described the eMMC MKEV008GCB-SS510 of methods and abstractions of reliability. The contents include the concept and measurement methodologies.

[Top page](#)

MK Confidential



## 4. General Description

MKEV008GCB-SS510 is the eMMC Technology of product, which is an embedded non-volatile memory system package into BGA. It has high performance, low power consumption features and supports eMMC4.5, eMMC5.01 and eMMC5.1 specifications.

### 4.1 Product list

Capacities	Part Number	Flash Type	Package Size (mm)	Package Type
8GB	MKEV008GCB-SS510	64Gb TLCx1	11.5x13x1.0	153FBGA

Table 5.1 eMMC product list

[Top page](#)

### 4.2 Feature

#### HS200 Bus Speed Mode

■ **The HS200 mode has the following features**

- SDR Data sampling method
- CLK frequency up to 200 MHz Data rate – up to 200 MB/s
- 4 or 8-bits bus width supported
- Signaling levels of 1.8 V
- Tuning concept for Read Operations

■ **Device type values (EXT\_CSD Register : DEVICE\_TYPE [196])**

Bit	Device Type	Supportability
7	HS400 Dual Data Rate e•MMC @ 200 MHz - 1.2V I/O	Not support
6	HS400 Dual Data Rate e•MMC @ 200 MHz - 1.8V I/O	Not support
5	HS200 Single Data Rate e•MMC @ 200 MHz - 1.2V I/O	Not support
4	HS200 Single Data Rate e•MMC @ 200 MHz - 1.8V I/O	Support
3	High-Speed Dual Data Rate e•MMC @ 52MHz - 1.2V I/O	Not support
2	High-Speed Dual Data Rate e•MMC @ 52MHz - 1.8V or 3V I/O	Support

1	High-Speed e•MMC @ 52MHz - at rated device voltage(s)	Support
0	High-Speed e•MMC @ 26MHz - at rated device voltage(s)	Support

**Note :** It is being discussed in JEDEC and is not confirmed yet. It can be modified according to JEDEC standard in the future.

■ **Extended CSD revisions (EXT\_CSD Register : EXT\_CSD\_REV [192])**

Value	Timing Interface	EXT_CSD Register Value
255-9	Reserved	-
8	Revision 1.8 (for MMC v5.1)	-
7	Revision 1.7 (for MMC V5.0)	0x07h
6	Revision 1.6 (for MMC V4.5, V4.51)	-
5	Revision 1.5 (for MMC V4.41)	-
4	Revision 1.4 (Obsolete)	-
3	Revision 1.3 (for MMC V4.3)	-
2	Revision 1.2 (for MMC V4.2)	-
1	Revision 1.1 (for MMC V4.1)	-
0	Revision 1.0 (for MMC V4.0)	-

**Note :** Current e•MMC standard defined by JEDEC supports up to 0x07 for EXT\_CSD\_REV value.

■ **High Speed timing values (EXT\_CSD Register: HS\_TIMING [185])**

Value	Timing Interface	Supportability
0x0	Selecting backwards compatibility interface timing	Support
0x1	High Speed	Support
0x2	HS200	Support
0x3	HS400	Not Support

[Top page](#)

## 6. Pin Description

### 6.1 eMMC 153 Ball Pin Assignment

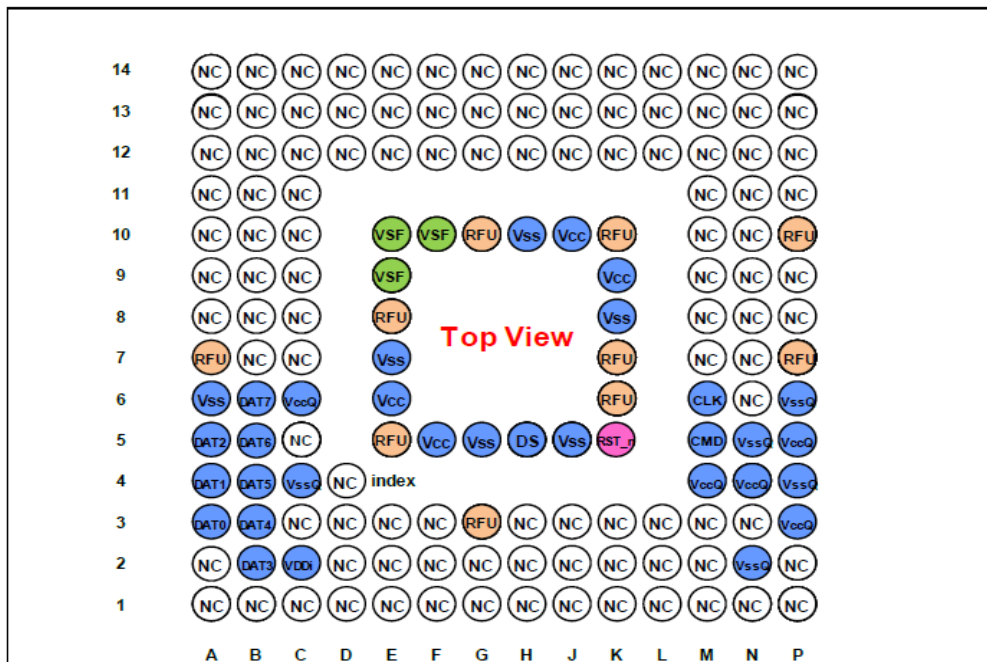

Figure 6-1 eMMC 153 ball pin assignment (Top view)

Ball No.	Name	Ball No.	Name	Ball No.	Name	Ball No.	Name
A3	DAT0	C2	VDDi	J5	V <sub>ss</sub>	N4	V <sub>ccQ</sub>
A4	DAT1	C4	V <sub>ssQ</sub>	J10	V <sub>cc</sub>	N5	V <sub>ssQ</sub>
A5	DAT2	C6	V <sub>ccQ</sub>	K5	RST <sub>n</sub>	P3	V <sub>ccQ</sub>
A6	V <sub>ss</sub>	E6	V <sub>cc</sub>	K8	V <sub>ss</sub>	P4	V <sub>ssQ</sub>
B2	DAT3	E7	V <sub>ss</sub>	K9	V <sub>cc</sub>	P5	V <sub>ccQ</sub>
B3	DAT4	F5	V <sub>cc</sub>	M4	V <sub>ccQ</sub>	P6	V <sub>ssQ</sub>
B4	DAT5	G5	V <sub>ss</sub>	M5	CMD	--	--
B5	DAT6	H5	DS	M6	CLK	--	--
B6	DAT7	H10	V <sub>ss</sub>	N2	V <sub>ssQ</sub>	--	--

**Note :**

**NC:** No Connect, can be connected to ground or left floating.

**RFU:** Reserved for Future Use, should be left floating for future use.

**VSF:** Vendor Specific Function, shall be left floating.

## 6.2 eMMC Pin Description

Signal	Ball No.	Description
CLOCK (CLK)	M6	Each cycle of the clock directs a transfer on the command line and on the data lines.
COMMAND (CMD)	M5	This signal is a bidirectional command channel used for device initialization and command transfer. The CMD Signal has 2 operation modes: open drain for initialization, and push-pull for fast command transfer.
DATA (DAT0-DAT7)	A3~A5 B2~B6	These are bidirectional data channels. The DAT signals operate in push-pull mode.
RST_n	K5	Hardware Reset Input
DS	H5	Data Strobe: Return Clock signal used in HS400 mode
V <sub>CCQ</sub>	C6,M4,N4,P3,P5	Power supply for MMC interface and Controller, have two power mode: High power mode:2.7V~3.6V; Lower power mode:1.7V~1.95V
V <sub>CC</sub>	E6,F5,J10,K9	Power supply for NAND flash memory, its power voltage range is: 2.7V~3.6V
VDDi	C2	VDDi is internal power mode. Connect 0.1uF or 2.2uF capacitor from VDDi to ground
V <sub>SS</sub> ,V <sub>SSQ</sub>	A6, E7, G5, H10, J5, J8,C4,N2,P4,P6	Ground lines

**Note :** All other pins are not connected [NC] and can be connected to GND or left floating.

Table 6-1 eMMC Pin Description

[Top page](#)

## 7. DC Electrical Characteristics

### 7.1 General operating conditions

8	Parameter	Symbol	Min	Max	Unit	Remarks
	Peak voltage on all lines	--	-0.5	V <sub>CCQ</sub> +0.5	V	--
<b>All Inputs</b>						
	Input Leakage Current (before initialization sequence and/or the internal pull up resistors connected)	--	-100	100	uA	--
	Input Leakage Current (after initialization sequence and the internal pull up resistors disconnected)	--	-2	2	uA	--
<b>All Outputs</b>						
	Output Leakage Current (before initialization sequence)	--	-100	100	uA	--
	Output Leakage Current (after initialization sequence)	--	-2	2	uA	--

**Note :** Initialization sequence is defined in Power-Up chapter of JEDEC/MMCA Standard.

Table 7-1 General Operating Conditions

[Top page](#)

## 7.2 Operating Current (RMS)

### ■ Active Power Consumption during operation

Capacity	NAND Type	Operation	I <sub>cc</sub>	I <sub>ccq</sub>	Unit
			(Max)	(Max)	
8 GB	64Gb x 1	Read	50	150	mA
		Write	50	100	mA

#### Note:

- Power measurement conditions: Bus configuration =x8 @200MHz DDR
- Max RMS current is the average RMS current consumption over a period of 100ms.
- Temperature: 25°C
- V<sub>cc</sub>=3.3V, V<sub>ccq</sub>=1.8V
- Not 100% tested

Figure 7-2 Operating Current

[Top page](#)

## 7.3 Power supply voltage

Parameter	Symbol	Test Conditions	Min	Max	Unit
Supply voltage1 (NAND/Core)	V <sub>cc</sub>	--	2.7	3.6	V
Supply voltage 2 (CTRL/IO)	V <sub>ccq</sub>	--	1.7	1.95	V
			2.7	3.6	V

Table 7-2 Power Supply Voltage

[Top page](#)

## 7.4 Standby Power Consumption

### ■ Standby Power Consumption in auto power saving mode and standby state

Capacity	NAND Type	State	Icc		Iccq		Unit
			25°C	85°C	25°C	85°C	
8 GB	64Gb x 1	Standby	50	150	150	600	uA
			50	150	150	600	uA

#### Note:

- Power measurement conditions: Bus configuration =x8, No CLK
- $V_{CC}=3.3V$ ,  $V_{CCQ}=1.8V$
- Not 100% tested

## 7.5 Sleep Power Consumption

### ■ Sleep Power Consumption in Sleep State

Capacity	NAND Type	State	Icc		Iccq		Unit
			25°C	85°C	25°C	85°C	
8 GB	64Gb x 1	Sleep	0	0	150	600	uA
			0	0	150	600	uA

#### Note:

- Power measurement conditions: Bus configuration = x8, No CLK
- Enter sleep state by CMD5,  $V_{CC}$  power is switched off,  $V_{CCQ}=1.8V$
- Not 100% tested

## 7.6 Bus Signal Line Loading

The total capacitance  $C_L$  of each line of the eMMC bus is the sum of the bus master capacitance  $C_{HOST}$ , the bus capacitance  $C_{BUS}$  itself and the capacitance  $C_{DEVICE}$  of the eMMC connected to this line:

$$C_L = C_{HOST} + C_{BUS} + C_{DEVICE}$$

The sum of the host and bus capacitances should be under 20pF.

### ■ Bus Signal Line Load

Parameter	Symbol	Min	Typ.	Max	Unit	Remark
Pull-up resistance for CMD	$R_{CMD}$	4.7	--	100	k $\Omega$	to prevent bus floating
Pull-up resistance for DAT0-7	$R_{DAT}$	10	--	100	k $\Omega$	to prevent bus floating
Internal pull up resistance DAT1-DAT7	$R_{int}$	10	--	150	k $\Omega$	to prevent unconnected lines floating
Bus signal line capacitance	$C_L$	--	--	30	pF	Single Device
Single Device capacitance	$C_{DEVICE}$	--	--	12	pF	Single Device capacitance
Maximum signal line inductance	--	--	--	16	nH	$f_{PP} \leq 52$ MHz

Table 7-6 Bus Signal Line Loading

[Top page](#)



## 8. eMMC Register Description

Software designers should refer to the particular implementation to do the programming. This section introduces the registers in eMMC and the values that are used in MKEV008GCB-SS510. The following table is the register list of current specification. The detail functionality is not described here; please reference to latest eMMC specifications.

[Top page](#)

### 8.1 Operation Conditions Register (OCR) Register

The 32-bit operation conditions register (OCR) stores the VDD voltage profile of the Device and the access mode indication. In addition, this register includes a status information bit. This status bit is set if the Device power up procedure has been finished. The OCR register shall be implemented by all Devices.

OCR bit	V <sub>CCQ</sub> voltage window	e•MMC
[6:0]	Reserved	000 0000b
[7]	1.7–1.95	1b
[14:8]	2.0–2.6	000 0000b
[23:15]	2.7–3.6	1 1111 1111b
[28:24]	Reserved	000 0000b
[30:29]	Access Mode	00b (byte mode) 10b (sector mode)
[31]	Card power up status bit (busy)*	

**Note\*** : This bit is set to LOW if the e•MMC has not finished the power up routine. The supported voltage range is coded as shown in table.

Table 8-1 OCR Table

[Top page](#)

## 8.2 SD Card Identification Register (CID)

The Device Identification (CID) register is 128 bits wide. It contains the Device identification information used during the Device identification phase (eMMC protocol). Every individual flash or I/O Device shall have a unique identification number. Every type of eMMC Device shall have a unique identification number. Table 75 lists these identifiers. The structure of the CID register is defined in this section.

Name	Field	Width	CID-slice	CID Value
Manufacturer ID	MID	8	[127:120]	EAh
Reserved	-	6	[119:114]	0h
Card/BGA	CBX	2	[113:112]	01h
OEM/Application ID	OID	8	[111:104]	0Eh
Product name	PNM	48	[103:56]	53 50 65 4D 4D 43 (SPeMMC)
Product revision	PRV	8	[55:48]	10h
Product serial number	PSN	32	[47:16]	Serial number
Manufacturing date	MDT	8	[15:8]	Manufacturing date
CRC7 checksum	CRC	7	[7:1]	CRC7
Not used, always '1'	-	1	[0:0]	1h

Table 8-3 CID Table

[Top page](#)

## 8.3 Driver Stage Register (DSR)

The 16-bit driver stage register (DSR) is optionally used to improve the bus performance for extended operating conditions. The CSD register carries the information about the DSR register usage. The default value of the DSR register is 0x404.

[Top page](#)

## 8.4 Relative Card Address Register (RCA)

The writable 16-bit relative Device address (RCA) register carries the Device address assigned

by the host during the Device identification. This address is used for the addressed host-Device communication after the Device identification procedure. The default value of the RCA register is 0x0001. The value 0x0000 is reserved to set all Devices into the Stand-by State with CMD7.

[Top page](#)

## 8.5 Card Specific Data Register (CSD)

The Card-Specific Data register provides information on how to access the eMMC contents. The CSD defines the data format, error correction type, maximum data access time, data transfer speed, whether the DSR register can be used etc. The programmable part of the register (entries marked by W or E, see below) can be changed by CMD27. The type of the entries in the table below is coded as follows:

- 9 R: Read only
- 10 W: One time programmable and not readable.
- 11 R/W: One time programmable and readable.
- 12 W/E: Multiple writable with value kept after power failure, H/W reset assertion and any CMD0 reset and not readable.
- 13 R/W/E: Multiple writable with value kept after power failure, H/W reset assertion and any CMD0 reset and readable.
- 14 R/W/C\_P: Writable after value cleared by power failure and HW/ rest assertion (the value not cleared by CMD0 reset) and readable.
- 15 R/W/E\_P: Multiple writable with value reset after power failure, H/W reset assertion and any CMD0 reset and readable.
- 16 W/E/\_P: Multiple writable with value reset after power failure, H/W reset assertion and any CMD0 reset and not readable.

Name	Field	Width	Cell Type	CSD-slice	Value
CSD structure	CSD_STRUCTURE	2	R	[127:126]	3h
System specification version	SPEC_VERS	4	R	[125:122]	4h
Reserved	-	2	R	[121:120]	0h
Data read access-time 1	TAAC	8	R	[119:112]	7Fh
Data read access-time 2 in CLK cycles (NSAC*100)	NSAC	8	R	[111:104]	8h
Max. bus clock frequency	TRAN_SPEED	8	R	[103:96]	32h
Card command classes	CCC	12	R	[95:84]	5F5h

**MKEV008GCB-SS510**

Max. read data block length	READ_BL_LEN	4	R	[83:80]	9h
Partial blocks for read allowed	READ_BL_PARTIAL	1	R	[79:79]	0h
Write block misalignment	WRITE_BLK_MISALIGN	1	R	[78:78]	0h
Read block misalignment	READ_BLK_MISALIGN	1	R	[77:77]	0h
DSR implemented	DSR_IMP	1	R	[76:76]	0h
Reserved	-	2	R	[75:74]	0h
Device size	C_SIZE	12	R	[73:62]	FFFh
Max. read current @ VDD min	VDD_R_CURR_MIN	3	R	[61:59]	6h
Max. read current @ VDD max	VDD_R_CURR_MAX	3	R	[58:56]	6h
Max. write current @ VDD min	VDD_W_CURR_MIN	3	R	[55:53]	6h
Max. write current @ VDD max	VDD_W_CURR_MAX	3	R	[52:50]	6h
Device size multiplier	C_SIZE_MULT	3	R	[49:47]	7h
Erase group size	ERASE_GRP_SIZE	5	R	[46:42]	1Fh
Erase group size multiplier	ERASE_GRP_MULT	5	R	[41:37]	1Fh
Write protect group size	WP_GRP_SIZE	5	R	[36:32]	Fh
Write protect group enable	WP_GRP_MULT	1	R	[31:31]	1h
Manufacturer default	ECC_DEFAULT_ECC	2	R	[30:29]	0h
Write speed factor	R2W_FACTOR	3	R	[28:26]	5h
Max. write data block length	WRITE_BL_LEN	4	R	[25:22]	9h
Partial blocks for write allowed	WRITE_BL_PARTIAL	1	R	[21:21]	0h
Reserved	-	4	R	[20:17]	0h
Content protection application	CONTENT_PROT_APP	1	R	[16:16]	0h
File format group	FILE_FORMAT_GRP	1	R/W	[15:15]	0h
Copy flag(OTP)	COPY	1	R/W	[14:14]	0h
Permanent write protection	PERM_WRITE_PROTECT	1	R/W	[13:13]	0h
Temporary write protection	TMP_WRITE_PROTECT	1	R/W/E	[12:12]	0h
File format	FILE_FORMAT	2	R/W	[11:10]	0h
CRC	CRC	7	R/W/E	[7:1]	0h
Not used, always '1'	-	1	-	[0:0]	1h

**Table 8-4 CSD Table**
[Top page](#)

## 8.6 Extended CSD register

17 The Extended CSD register defines the e•MMC properties and selected modes. It is 512 bytes long.

18

19 The most significant 320 bytes are the Properties segment, which defines the e•MMC capabilities and cannot be modified by the host. The lower 192 bytes are the Modes segment, which defines the configuration the e•MMC is working in. These modes can be changed by the host by means of the SWITCH command.

20 R: Read only

21 W: One time programmable and not readable.

22 R/W: One time programmable and readable.

23 W/E: Multiple writable with value kept after power failure, H/W reset assertion and any CMD0 reset and not readable.

24 R/W/E: Multiple writable with value kept after power failure, H/W reset assertion and any CMD0 reset and readable.

25 R/W/C\_P: Writable after value cleared by power failure and HW/ rest assertion (the value not cleared by CMD0 reset) and readable.

26 R/W/E\_P: Multiple writable with value reset after power failure, H/W reset assertion and any CMD0 reset and readable.

27 W/E/\_P: Multiple writable with value reset after power failure, H/W reset assertion and any CMD0 reset and not readable.

Name	Field	Size (Bytes)	Cell Type	CSD-slice	Value
Properties Segment					
Reserved	-	6	TBD	[511:506]	0h
Extended Security Commands Error	EXT_SECURITY_ERR	1	R	[505]	0h
Supported Command Sets	S_CMD_SET	1	R	[504]	1h
HPI features	HPI_FEATURES	1	R	[503]	1h

**MKEV008GCB-SS510**

Background operations support	BKOPS_SUPPORT	1	R	[502]	1h
Max packed read commands	MAX_PACKED_READS	1	R	[501]	Ah
Max packed write commands	MAX_PACKED_WRITES	1	R	[500]	Ah
Data Tag Support	DATA_TAG_SUPPORT	1	R	[499]	1h
Tag Unit Size	TAG_UNIT_SIZE	1	R	[498]	5h
Tag Resources Size	TAG_RES_SIZE	1	R	[497]	1h
Context management capabilities	CONTEXT_CAPABILITIES	1	R	[496]	5h
Large Unit size	LARGE_UNIT_SIZE_M1	1	R	[495]	7h
Extended partitions attribute support	EXT_SUPPORT	1	R	[494]	3h
Supported modes	SUPPORTED_MODES	1	R	[493]	1h
FFU features	FFU_FEATURES	1	R	[492]	1h
Operation codes timeout	OPERATION_CODE_TIMEOUT	1	R	[491]	40h
FFU Argument	FFU_ARG	4	R	[490:487]	0h
Barrier support	BARRIER_SUPPORT	1	R	[486]	0h
Reserved	-	177	TBD	[485:309]	All "0"
CMD Queuing Support	CMDQ_SUPPORT	1	R	[308]	1h
CMD Queuing Depth	CMDQ_DEPTH	1	R	[307]	1Fh
Reserved	-	1	TBD	[306]	0h
Vendor proprietary health report	VENDOR_PROPRIETARY_HEALTH_REPORT	32	R	[301:270]	0h
Device life time estimation type B	DEVICE_LIFE_TIME_EST_TYP_B	1	R	[269]	All "0"
Device life time estimation type A	DEVICE_LIFE_TIME_EST_TYP_A	1	R	[268]	0h
<b>Name</b>	<b>Field</b>	<b>Size (Bytes)</b>	<b>Cell Type</b>	<b>CSD-slice</b>	<b>Value</b>
Pre EOL information	PRE_EOL_INFO	1	R	[267]	0h
Optimal read size	OPTIMAL_READ_SIZE	1	R	[266]	0h
Optimal write size	OPTIMAL_WRITE_SIZE	1	R	[265]	0h

**MKEV008GCB-SS510**

Optimal trim unit size	OPTIMAL_TRIM_UNIT_SIZE	1	R	[264]	0h
Device version	DEVICE_VERSION	2	R	[263:262]	0h
Firmware version	FIRMWARE_VERSION	8	R	[261:254]	0h
Power class for 200MHz, DDR at V <sub>CC</sub> = 3.6V	PWR_CL_DDR_200_360	1	R	[253]	0h
Cache size	CACHE_SIZE	4	R	[252:249]	0h
Generic CMD6 timeout	GENERIC_CMD6_TIME	1	R	[248]	0h
Power off notification(long) timeout	POWER_OFF_LONG_TIME	1	R	[247]	10h
Background operations status	BKOPS_STATUS	1	R	[246]	2h
Number of correctly programmed sectors	CORRECTLY_PRG_SECTORS_NUM	4	R	[245:242]	0h
1st initialization time after partitioning	INI_TIMEOUT_AP	1	R	[241]	0h
Cache Flushing Policy	CACHE_FLUSH_POLICY	1	R	[240]	0h
Power class for 52MHz, DDR at V <sub>CC</sub> = 3.6V	PWR_CL_DDR_52_360	1	R	[239]	0h
Power class for 52MHz, DDR at V <sub>CC</sub> = 1.95V	PWR_CL_DDR_52_195	1	R	[238]	0h
Power class for 200MHz at V <sub>CCQ</sub> =1.95V, V <sub>CC</sub> = 3.6V	PWR_CL_200_195	1	R	[237]	0h
Power class for 200MHz, at V <sub>CCQ</sub> =1.3V, V <sub>CC</sub> = 3.6V	PWR_CL_200_130	1	R	[236]	0h
Minimum Write Performance for 8bit at 52MHz in DDR mode	MIN_PERF_DDR_W_8_52	1	R	[235]	0h
Minimum Read Performance for 8bit at 52MHz in DDR mode	MIN_PERF_DDR_R_8_52	1	R	[234]	0h
Reserved		2	TBD	[233]	0h
TRIM Multiplier	TRIM_MULT	1	R	[232]	10h
Secure Feature support	SEC_FEATURE_SUPPORT	1	R	[231]	55h
Secure Erase Multiplier	SEC_ERASE_MULT	1	R	[230]	1Bh

**MKEV008GCB-SS510**

Secure TRIM Multiplier	SEC_TRIM_MULT	1	R	[229]	11h
Boot information	BOOT_INFO	1	R	[228]	7h
Reserved		1	TBD	[227]	0h
Boot partition size	BOOT_SIZE_MULT	1	R	[226]	20h
Access size	ACC_SIZE	1	R	[225]	6h
High-capacity erase unit size	HC_ERASE_GRP_SIZE	1	R	[224]	1h
High-capacity erase timeout	ERASE_TIMEOUT_MULT	1	R	[223]	10h
Reliable write sector count	REL_WR_SEC_C	1	R	[222]	1h
High-capacity write protect group size	HC_WP_GRP_SIZE	1	R	[221]	10h
Sleep current [V <sub>CC</sub> ]	S_C_VCC	1	R	[220]	Dh
Sleep current [V <sub>CCQ</sub> ]	S_C_VCCQ	1	R	[219]	Dh
Production state awareness timeout	PRODUCTION_STATE_AWARENESS_TIMEOUT	1	R	[218]	6h
Sleep/awake timeout	S_A_TIMEOUT	1	R	[217]	17h
<b>Name</b>	<b>Field</b>	<b>Size (Bytes)</b>	<b>Cell Type</b>	<b>CSD-slice</b>	<b>Value</b>
Sleep Notification Timeout1	SLEEP_NOTIFICATION_TIMEOUT	1	R	[216]	0h
Sector Count	SEC_COUNT	4	R	[215:212]	E6A340h
Secure Write Protect Information	SECURE_WP_INFO	1	R	[211]	0h
Minimum Write Performance for 8bit at 52MHz	MIN_PERF_W_8_52	1	R	[210]	0h
Minimum Read Performance for 8bit at 52MHz	MIN_PERF_R_8_52	1	R	[209]	0h
Minimum Write Performance for 8bit at 26MHz, for 4bit at 52MHz	MIN_PERF_W_8_26_4_52	1	R	[208]	0h
Minimum Read Performance for 8bit at 26MHz, for 4bit at 52MHz	MIN_PERF_R_8_26_4_52	1	R	[207]	0h
Minimum Write Performance for 4bit at 26MHz	MIN_PERF_W_4_26	1	R	[206]	0h
Minimum Read Performance for	MIN_PERF_R_4_26	1	R	[205]	0h



**MKEV008GCB-SS510**

4bit at 26MHz					
Reserved		1	TBD	[204]	0h
Power class for 26MHz at 3.6 V 1 R	PWR_CL_26_360	1	R	[203]	0h
Power class for 52MHz at 3.6 V 1 R	PWR_CL_52_360	1	R	[202]	0h
Power class for 26MHz at 1.95 V 1 R	PWR_CL_26_195	1	R	[201]	0h
Power class for 52MHz at 1.95 V 1 R	PWR_CL_52_195	1	R	[200]	0h
Partition switching timing	PARTITION_SWITCH_TIM E	1	R	[199]	FFh
Out-of-interrupt busy timing	OUT_OF_INTERRUPT_TI ME	1	R	[198]	64h
I/O Driver Strength	DRIVER_STRENGTH	1	R	[197]	0h
Device type	DEVICE_TYPE	1	R	[196]	17h
Reserved		1	TBD	[195]	0h
CSD Structure Version	CSD_STRUCTURE	1	R	[194]	2h
Reserved		1	TBD	[193]	0h
Extended CSD Revision	EXT_CSD_REV	1	R	[192]	7h
<b>Modes Segment</b>					
Command Set	CMD_SET	1	R/W/E_P	[191]	0h
Reserved		1	TBD	[190]	0h
Command set revision	CMD_SET_REV		R	[189]	0h
Reserved		1	TBD	[188]	0h
Power class	POWER_CLASS		R/W/E_P	[187]	0h
Reserved		1	TBD	[186]	0h
High Speed Interface Timing	HS_TIMING	1	R/W/E_P	[185]	2h
Reserved		1	TBD	[184]	0h
Bus Width Mode	BUS_WIDTH	1	W/E_P	[183]	2h
Reserved		1	TBD	[182]	0h
Erased memory range	ERASE_MEM_CONT	1		[181]	0h
Reserved		1	TBD	[180]	0h
Partition Configuration	PARTITION_CONFIG	1	R/W/E & R/W/E_P	[179]	0h

Name	Field	Size (Bytes)	Cell Type	CSD-slice	Value
Boot Config protection	BOOT_CONFIG_PROT	1	R/W &R/W/C_P	[178]	0h
Boot bus Conditions	BOOT_BUS_CONDITIONS	1	R/W/E	[177]	0h
Reserved		1	TBD	[176]	0h
High-density erase group definition	ERASE_GROUP_DEF	1	R/W/E	[175]	0h
Boot write protection status registers	BOOT_WP_STATUS	1	R	[174]	0h
Boot area write protect register	BOOT_WP	1	R/W &R/W/C_P	[173]	0h
Reserved		1	TBD	[172]	0h
User area write protect register	USER_WP	1	R/W,R/W/ C_P &R/W/E_P	[171]	0h
Reserved		1	TBD	[170]	0h
FW configuration	FW_CONFIG	1	R/W	[169]	0h
RPMB Size	RPMB_SIZE_MULT	1	R	[168]	20h
Write reliability setting register	WR_REL_SET	1	R/W	[167]	1Fh
Write reliability parameter register	WR_REL_PARAM	1	R	[166]	14h
Start Sanitize operation	SANITIZE_START	1	W/E_P	[165]	0h
Manually start background operations	BKOPS_START	1	W/E_P	[164]	0h
Enable background operations handshake	BKOPS_EN	1	R/W & R/W/E	[163]	0h
H/W reset function	RST_n_FUNCTION	1	R/W	[162]	0h
HPI management	HPI_MGMT	1	R/W/E_P	[161]	0h
Partitioning Support	PARTITIONING_SUPPORT	1	R	[160]	7h
Max Enhanced Area Size	MAX_ENH_SIZE_MULT	3	R	[159:157]	133h

				]	
Partitions attribute	PARTITIONS_ATTRIBUTE	1	R/W	[156]	0h
Partitioning Setting	PARTITION_SETTING_COMPLETED	1	R/W	[155]	0h
General Purpose Partition Size	GP_SIZE_MULT	12	R/W	[154:143]	0h
Enhanced User Data Area Size	ENH_SIZE_MULT	3	R/W	[142:140]	0h
Enhanced User Data Start Address	ENH_START_ADDR	4	R/W	[139:136]	0h
Reserved		1	TBD	[135]	0h
Bad Block Management mode	SEC_BAD_BLK_MGMNT	1	R/W	[134]	0h
Production state awareness	PRODUCTION_STATE_AWARENESS	1	R/W/E	[133]	0h
Package Case Temperature is controlled	TCASE_SUPPORT	1	W/E_P	[132]	0h
Periodic Wake-up	PERIODIC_WAKEUP	1	R/W/E	[131]	0h
Program CID/CSD in DDR mode support	PROGRAM_CID_CSD_DDR_SUPPORT	1	R	[130]	0h
Reserved		2	TBD	[129:128]	0h
Vendor Specific Fields	NATIVE_SECTOR_SIZE	1	<vendor specific>	[127:64]	0h
Native sector size	NATIVE_SECTOR_SIZE	1	R	[63]	0h
Sector size emulation	USE_NATIVE_SECTOR	1	R/W	[62]	0h
Sector size	DATA_SECTOR_SIZE	1	R	[61]	0h
1st initialization after disabling sector size emulation	INI_TIMEOUT_EMU	1	R	[60]	0h
Class 6 commands control	CLASS_6_CTRL	1	R/W/E_P	[59]	0h
Number of addressed group to be Released	DYNCAP_NEEDED	1	R	[58]	0h
<b>Name</b>	<b>Field</b>	<b>Size (Bytes)</b>	<b>Cell Type</b>	<b>CSD-slice</b>	<b>Value</b>
Exception events control	EXCEPTION_EVENTS_CTL	2	R/W/E_P	[57:56]	0h

	RL				
Exception events status	EXCEPTION_EVENTS_STATUS	2	R	[55:54]	0h
Extended Partitions Attribute	EXT_PARTITIONS_ATTRIBUTE	2	R/W	[53:52]	0h
Context configuration	CONTEXT_CONF	15	R/W/E_P	[51:37]	0h
Packed command status	PACKED_COMMAND_STATUS	1	R	[36]	0h
Packed command failure index	PACKED_FAILURE_INDEX	1	R	[35]	0h
Power Off Notification	POWER_OFF_NOTIFICATION	1	R/W/E_P	[34]	0h
Control to turn the Cache ON/OFF	CACHE_CTRL	1	R/W/E_P	[33]	0h
Flushing of the cache	FLUSH_CACHE	1	W/E_P	[32]	0h
Control to turn the Barrier ON/OFF	BARRIER_CTRL	1	R/W	[31]	0h
Mode config	MODE_CONFIG	1	R/W/E_P	[30]	0h
Mode operation codes	MODE_OPERATION_CODES	1	W/E_P	[29]	0h
Reserved		2	TBD	[28:27]	0h
FFU status	FFU_STATUS	1	R	[26]	0h
Pre loading data size	PRE_LOADING_DATA_SIZE	4	R/W/E_P	[25:22]	0h
Max pre loading data size	MAX_PRE_LOADING_DATA_SIZE	4	R	[21:18]	39A8D0h
Product state awareness enablement	PRODUCT_STATE_AWARENESS_ENABLEMENT	1	R/W/E & R	[17]	3h
Secure Removal Type	SECURE_REMOVAL_TYPE	1	R/W & R	[16]	1h
Command Queue Mode Enable	CMDQ_MODE_EN	1	R/W/E_P	[15]	0h
Reserved		15	TBD	[14:0]	0h

**28 Note :** Reserved bits should be read as "0".

Table 8-5 Extend CSD Table

[Top page](#)

## 9. Production Specifications

### 9.1 Performance

Capacity	Part Number	Mode	Sustained Sequential Read (MB/s)	SLC Sequential Write (MB/s)	Sustained Sequential Write (MB/s)
8 GB	P/N	HS200	130	45	22

Test Condition: Bus width x8, 200MHz SDR, 512KB data transfer, w/o file system overhead, measured on internal board.

Table 9-1 MKEV008GCB-SS510 performance

[Top page](#)

## 9.2 Power Consumption

### Operating Current

Capacity	NAND Type	Operation	Icc	Iccq	Unit
			(Max)	(Max)	
8 GB	64Gb x 1	Read	50	150	mA
		Write	50	100	mA

#### Note:

- Power measurement conditions: Bus configuration =x8 @200MHz DDR
- Max RMS current is the average RMS current consumption over a period of 100ms.
- Temperature: 25°C
- $V_{CC}=3.3V$ ,  $V_{CCQ}=1.8V$
- Not 100% tested

### Standby Power Consumption

Capacity	NAND Type	State	Icc		Iccq		Unit
			25°C	85°C	25°C	85°C	
8 GB	64Gb x 1	Standby	50	150	150	600	uA
			50	150	150	600	uA

#### Note:

- Power measurement conditions: Bus configuration =x8, No CLK
- $V_{CC}=3.3V$ ,  $V_{CCQ}=1.8V$
- Not 100% tested

### Sleep Power Consumption

Capacity	NAND Type	State	Icc		Iccq		Unit
			25°C	85°C	25°C	85°C	
8 GB	64Gb x 1	Sleep	0	0	150	600	uA
			0	0	150	600	uA

#### Note:

## MKEV008GCB-SS510

- Power measurement conditions: Bus configuration = x8, No CLK
- Enter sleep state by CMD5,  $V_{CC}$  power is switched off,  $V_{CCQ}=1.8V$
- Not 100% tested

[Top page](#)

MK Confidential

# 10. Package Dimension

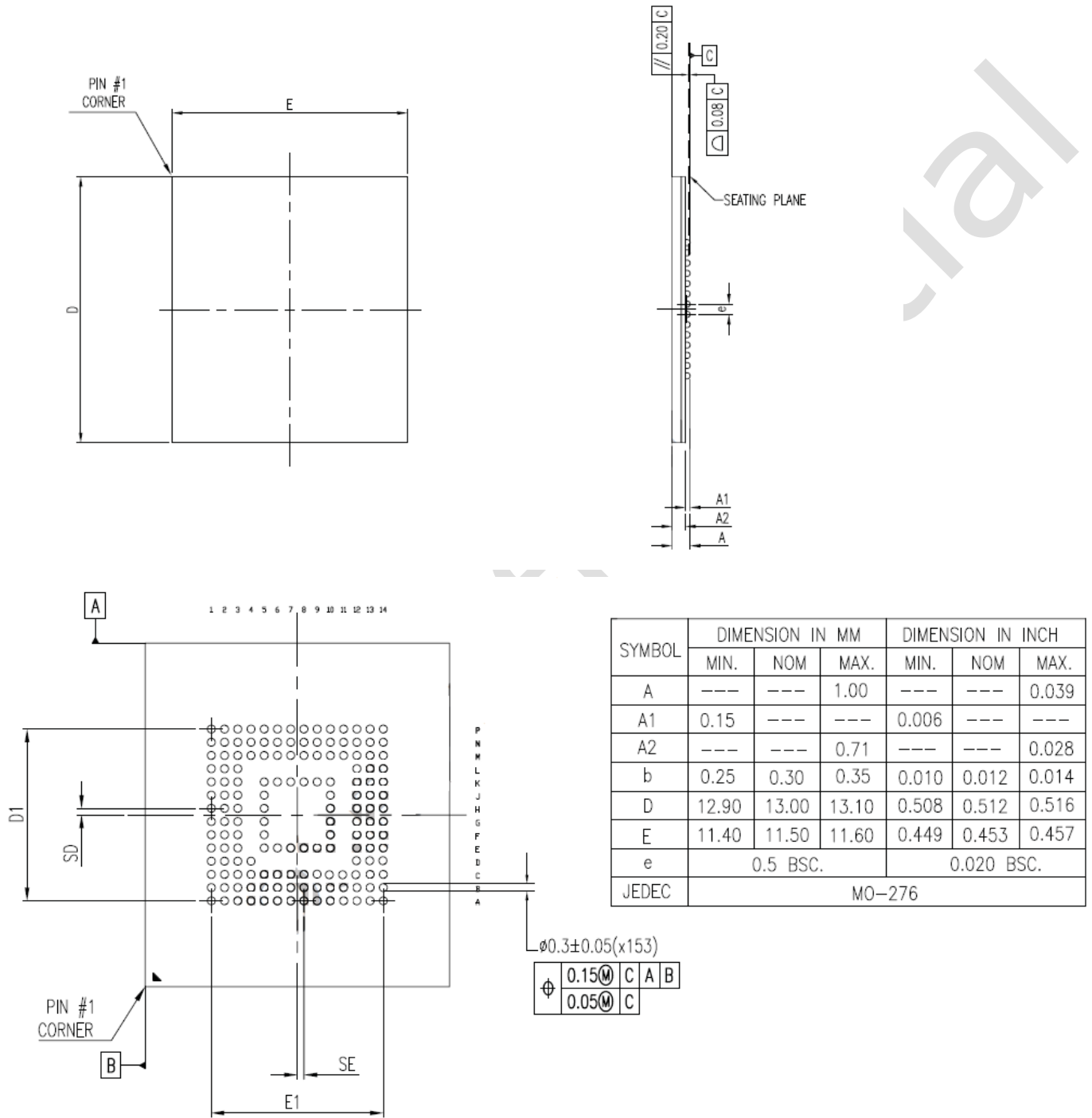

Figure 10-2 Package Outline Dimension Drawing

[Top page](#)



# 11. Partition Configuration

## 11.1 Partition Management

The memory configuration initially consists (before any partitioning operation) of the User Data Area and RPMB Area Partitions and two Boot Area Partitions.

The embedded device also offers the host the possibility to configure additional local memory partitions with independent address spaces, starting from logical address 0x00000000, for different usage models.

Therefore, the memory block areas can be classified as follows:

- Two Boot Area Partitions, whose size is multiple of 128 KB and where booting from eMMC can be performed.
- One RPMB Partition accessed through a trusted mechanism, whose size is defined as multiple of 128 KB.
- Four General Purpose Area Partitions to store sensitive data or for other host usage models, whose sizes are a multiple of a Write Protect Group.

Boot and RPMB Area Partitions' sizes and attributes are defined by the memory manufacturer (read-only), while General Purpose Area Partitions' sizes and attributes can be programmed by the host only once in the device life-cycle (one-time programmable).

Moreover, the host is free to configure one segment in the User Data Area to be implemented as enhanced storage media, and to specify its starting location and size in terms of Write Protect Groups. The attributes of this Enhanced User Data Area can be programmed only once during the device life-cycle (one-time programmable).

A possible final configuration can be the following:

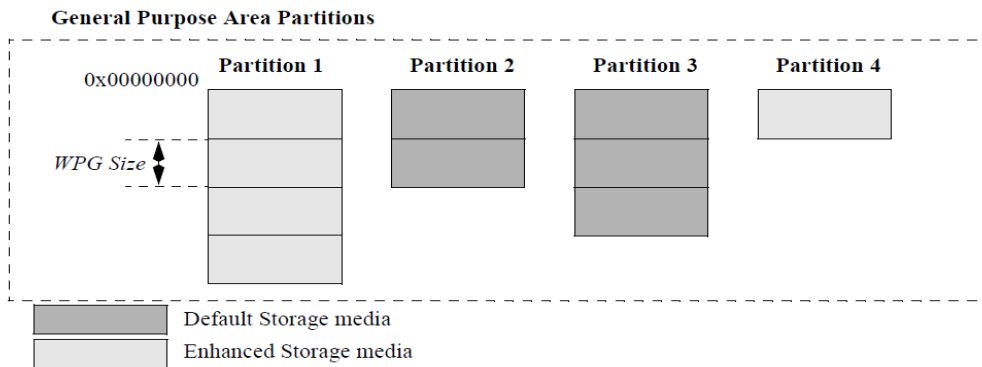
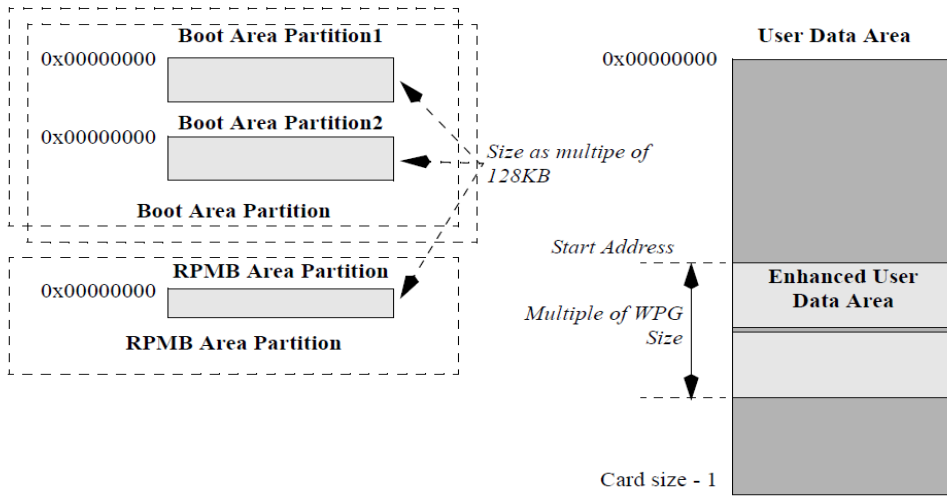

## 11.2 User Density

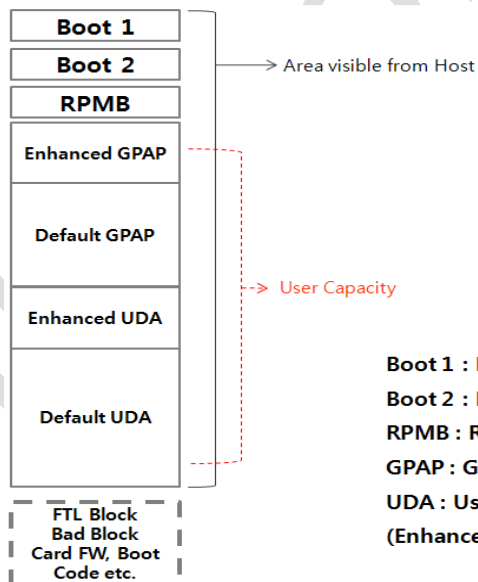

- Boot 1 :** Boot Area Partition 1
- Boot 2 :** Boot Area Partition 2
- RPMB :** Replay Protected Memory Block Area
- GPAP :** General Purpose Area Partitions
- UDA :** User Data Area
- (Enhanced: Enhanced Storage Media, Default: Default Storage Media)**

### ■ Boot and RPMB Size

Capacity	Boot1 Size	Boot2 Size	RPMB Size
8 GB	4096 KB	4096 KB	4096 KB

### ■ User Density Size

Capacity	User Area Capacity	SEC_COUNT in Extended CSD
8 GB	7,738,916,864 Bytes (7.2 GB)	0xE6A340

### ■ Maximum Enhanced Partition Size

Capacity	Max. Enhanced Partition Size	MAX_ENH_SIZE_MULT	HC_WP_GRP_SIZE	HC_ERASE_GRP_SIZE
8 GB	2,575,302,656 Bytes (2450 MB)	0x133h	0x10h	0x1h

Max Enhanced Area = MAX\_ENH\_SIZE\_MULT x HC\_WP\_GRP\_SIZE x HC\_ERASE\_GRP\_SIZE x 512kBytes

### 11.3 Boot Operation Mode

In boot operation mode, the master can read boot data from the slave (device) by keeping CMD line low or sending CMD0 with argument + 0xFFFFFFFF, before issuing CMD1. The data can be read from either boot area or user area depending on register setting.

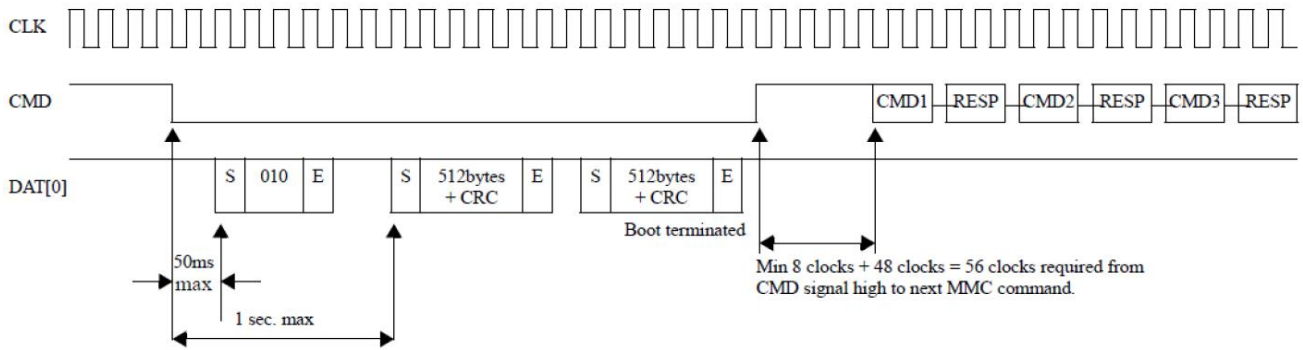

**State diagram (boot mode)**  
**Boot operation complete Clock = 400 kHz**  
**(Compatible with the description which ≤400kHz)**

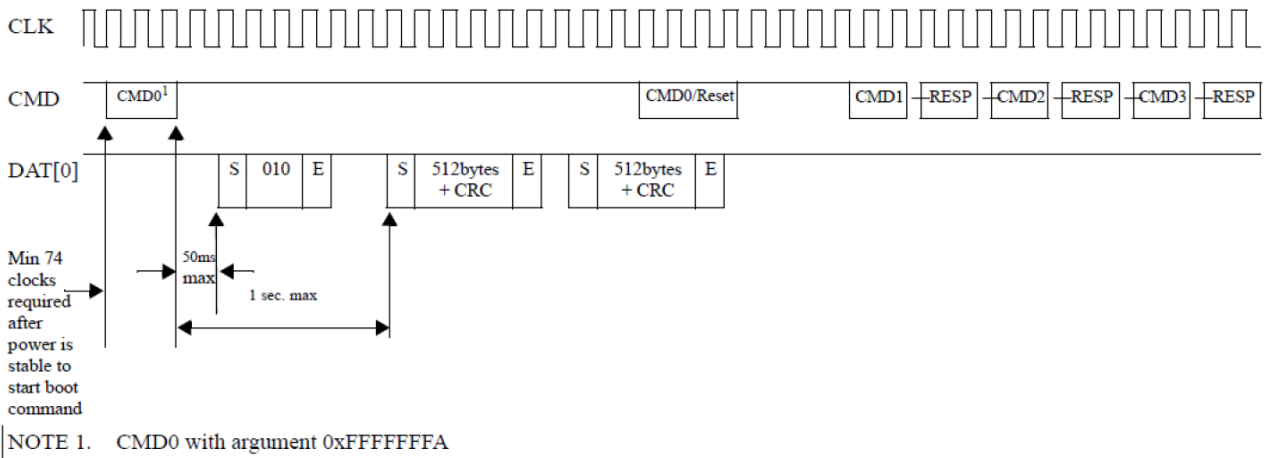

**State diagram (alternative boot mode)**

[Top page](#)