

## Power Choke Coil (Automotive Grade)

Series: **PCC-M0530M (MC) PCC-M0540M (MC)**  
**PCC-M0630M (MC) PCC-M0645M (MC)**  
**PCC-M0754M (MC) PCC-M0750M (MC)**  
**PCC-M0854M (MC) PCC-M0850M (MC)**  
**PCC-M1054M (MC) PCC-M1050M (MC)**  
**PCC-M1050ML (MC) PCC-M1060ML (MC)**

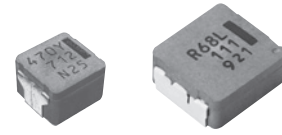

High heat resistance and high reliability  
 Using metal composite core (MC)

Industrial Property : patents 21 (Registered 2/Pending 19)

### Features

- High heat resistance : Operation up to 150 °C including self-heating
- High-reliability : High vibration resistance as result of newly developed integral construction; under severe reliability conditions of automotive and other strenuous applications
- High bias current : Excellent inductance stability using ferrous alloy magnetic material (Fig.1)
- Temp. stability : Excellent inductance stability over broad temp. range (Fig.1)
- Low audible (buzz) noise : New metal composite core technology
- High efficiency : Low  $R_{DC}$  of winding and low eddy-current loss of the core
- Shielded construction
- AEC-Q200 Automotive qualified
- RoHS compliant

● Fig.1 Inductance v.s. DC current, Temp.

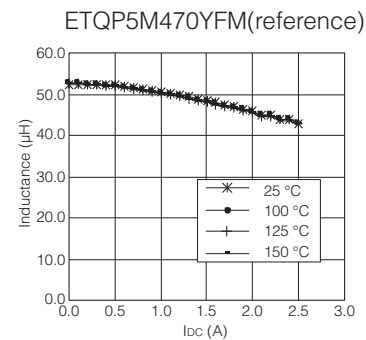

### Recommended Applications

- Noise filter for various drive circuitry requiring high temp. operation and peak current handling capability
- Boost-Converter, Buck-Converter DC/DC

### Standard Packing Quantity (Minimum Quantity/Packing Unit)

- 1,000 pcs./box (2 reel) : PCC-M0645M, M0754M, M0750M, M0854M, M0850M, M1054M, M1050M, M1050ML, M1060ML
- 2,000 pcs./box (2 reel) : PCC-M0530M, M0540M, M0630M

### Explanation of Part Numbers

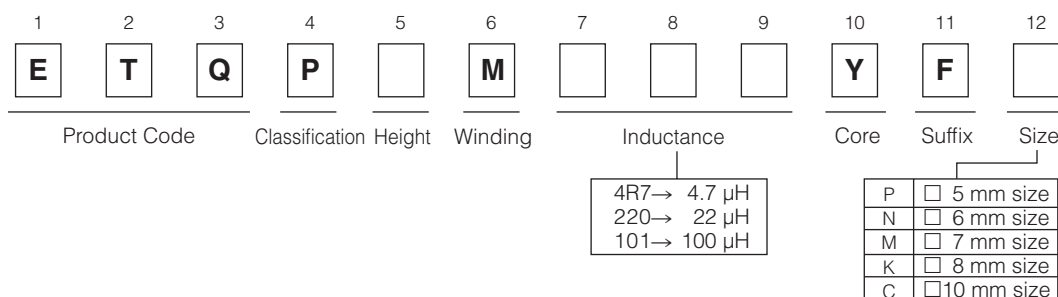

### Temperature rating

|                             |                     |  |
|-----------------------------|---------------------|--|
| Operating temperature range |                     | T <sub>c</sub> : -40 °C to +150 °C (Including self-temperature rise) |
| Storage condition           | After PWB mounting  |  |
|                             | Before PWB mounting | T <sub>a</sub> : -5 °C to +35 °C 85%RH max.                          |

## 1. Series PCC-M0530M/PCC-M0540M (ETQP3M□□□YFP/ETQP4M□□□YFP)

### Standard Parts

| Series                          | Part No.     | Inductance *1 |               | DCR (at 20 °C) (mΩ) |               | Rated Current (Typ. : A) |             |              |
|---------------------------------|--------------|---------------|---------------|---------------------|---------------|--------------------------|-------------|--------------|
|                                 |              | L0 (μH)       | Tolerance (%) | Typ. (max.)         | Tolerance (%) | ΔT=40K (*2)              | ΔT=40K (*3) | ΔL=-30% (*4) |
| PCC-M0530M<br>[5.5×5.0×3.0(mm)] | ETQP3M2R2YFP | 2.2           | ±20           | 22.6 ( 24.8)        | ±10           | 4.8                      | 5.8         | 10.9         |
|                                 | ETQP3M3R3YFP | 3.3           |               | 31.3 ( 34.4)        |               | 4.1                      | 5.0         | 8.6          |
| PCC-M0540M<br>[5.5×5.0×4.0(mm)] | ETQP4M4R7YFP | 4.7           |               | 36.0 ( 39.6)        |               | 4.0                      | 4.8         | 7.7          |
|                                 | ETQP4M220YFP | 22            |               | 163.0 (179.0)       |               | 1.9                      | 2.3         | 3.1          |

(\*1) Measured at 100 kHz.

(\*2) DC current which causes temperature rise of 40 K. Parts are soldered by reflow on four-layer PWB (1.6 mm FR4) and measured at room temperature. See also (\*5)

(\*3) DC current which causes temperature rise of 40 K. Parts are soldered by reflow on multilayer PWB with high heat dissipation performance. Note: Heat radiation constant are approx. 52 K/W measured on 5.5×5.0×3.0 mm case size and approx. 48 K/W measured on 5.5×5.0×4.0 mm case size. See also (\*5)

(\*4) Saturation rated current : DC current which causes L(0) drop -30 %.

(\*5) Within a suitable application, the part's temperature depends on circuit design and certain heat dissipation conditions. This should be double checked in a worst case operation mode.

In normal case, the max.standard operating temperature of +150 °C should not be exceeded.

For higher operating temperature conditions, please contact Panasonic representative in your area.

### Performance Characteristics (Reference)

#### ● Inductance vs DC Current

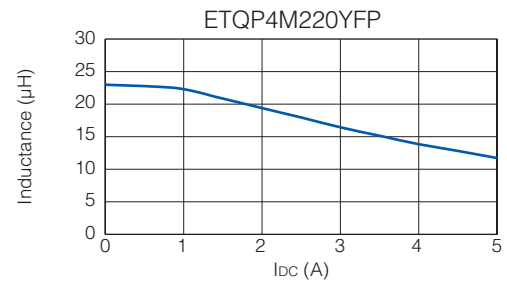
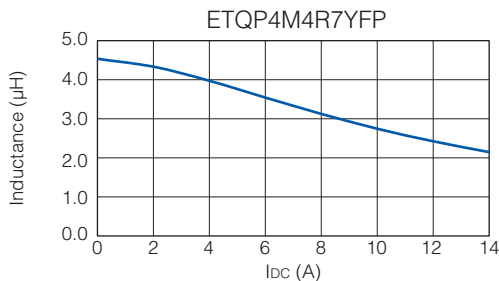
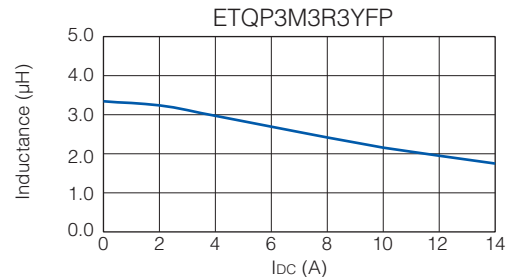
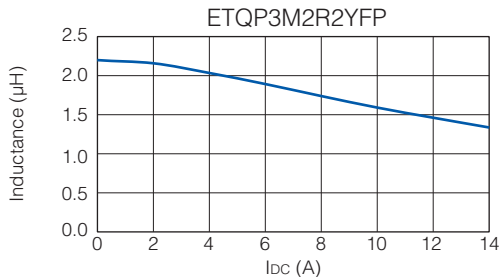

#### ● Case Temperature vs DC Current

PWB condition A : Four-layer PWB (1.6 mm FR4), See also (\*2)

PWB condition B : Multilayer PWB with high heat dissipation performance. See also (\*3)

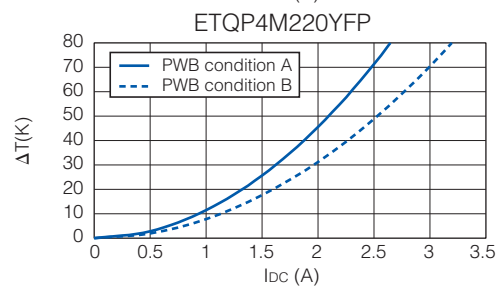
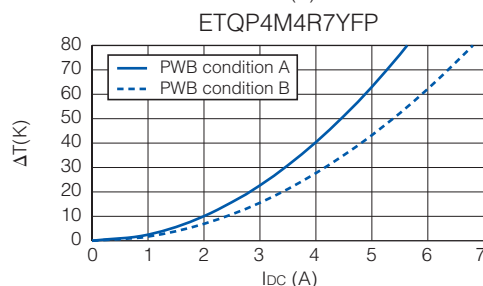
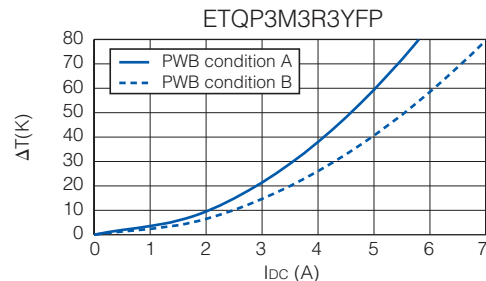
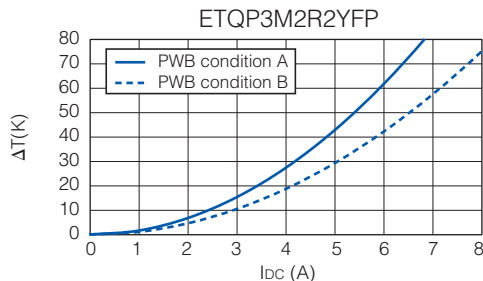

## 2. Series PCC-M0630M/PCC-M0645M (ETQP3M□□□YFN/ETQP4M□□□YFN)

| Standard Parts                                |              |                 |                  |                     |                  |                          |      |         |
|---|--------------|-----------------|------------------|---------------------|------------------|--------------------------|------|---------|
| Series  | Part No.     | Inductance *1   |                  | DCR (at 20 °C) (mΩ) |                  | Rated Current (Typ. : A) |      |         |
|   |              | L0<br>(μH)      | Tolerance<br>(%) | Typ.<br>(max.)      | Tolerance<br>(%) | ΔT=40K                   |      | ΔL=-30% |
|   |              |                 |                  |                     |                  | (*2)                     | (*3) | (*4)    |
| PCC-M0630M<br>[6.5×6.0×3.0(mm)]               | ETQP3MR68YFN | 0.68            | ±20              | 6.30 ( 6.90)        | ±10              | 9.8                      | 12.0 | 24.0    |
|   | ETQP3M1R0YFN | 1.0             |                  | 7.90 ( 8.70)        |                  | 8.8                      | 10.7 | 20.0    |
| <b>NEW</b><br>PCC-M0645M<br>[6.5×6.0×4.5(mm)] | ETQP4M3R3YFN | 3.3             |                  | 16.10 ( 17.71)      |                  | 6.4                      | 8.2  | 13.3    |
|   | ETQP4M6R8YFN | 6.8             |                  | 39.30 ( 43.20)      |                  | 4.1                      | 5.2  | 10.0    |
|   | ETQP4M100YFN | 10              |                  | 54.20 ( 59.60)      |                  | 3.3                      | 4.5  | 8.3     |
|   | ETQP4M220YFN | 22              |                  | 126.00 (138.60)     |                  | 2.3                      | 2.9  | 6.0     |
|   | ETQP4M330YFN | 33              |                  | 172.00 (189.20)     |                  | 2.0                      | 2.5  | 4.1     |
| ETQP4M470YFN                                  | 47           | 210.00 (231.00) |                  | 1.8                 |                  | 2.2                      | 3.8  |         |

(\*1) Measured at 100 kHz.

(\*2) DC current which causes temperature rise of 40 K. Parts are soldered by reflow on four-layer PWB (1.6 mm FR4) and measured at room temperature. See also (\*5)

(\*3) DC current which causes temperature rise of 40 K. Parts are soldered by reflow on multilayer PWB with high heat dissipation performance. Note: Heat radiation constant are approx. 44 K/W measured on 6.5×6.0×3.0 mm case size and approx. 37 K/W measured on 6.5×6.0×4.5 mm case size. See also (\*5)

(\*4) Saturation rated current : DC current which causes L(0) drop -30 %.

(\*5) Within a suitable application, the part's temperature depends on circuit design and certain heat dissipation conditions. This should be double checked in a worst case operation mode.

In normal case, the max. standard operating temperature of +150 °C should not be exceeded.

For higher operating temperature conditions, please contact Panasonic representative in your area.

## Performance Characteristics (Reference)

### ● Inductance vs DC Current

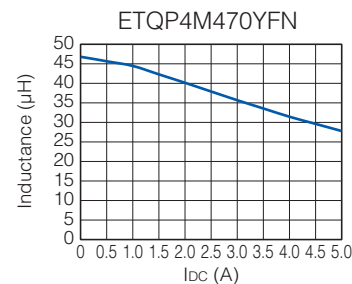
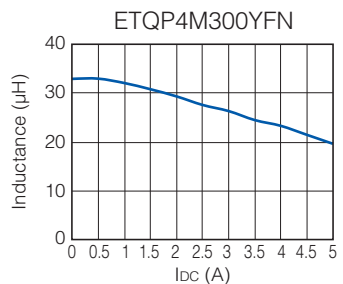
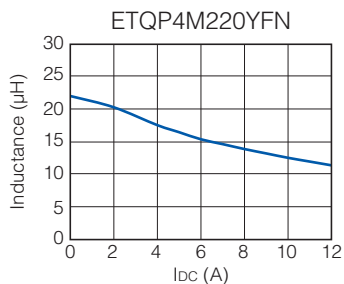
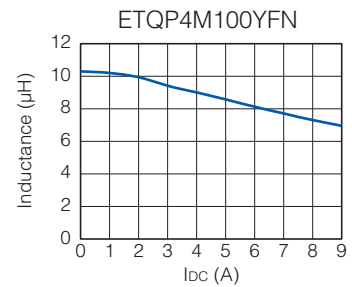
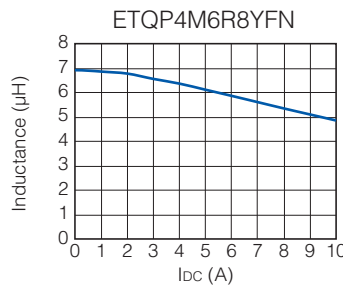
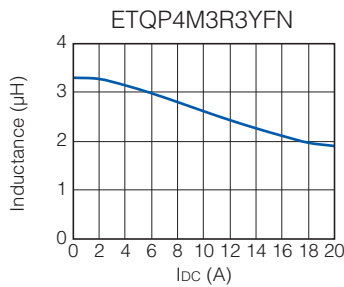
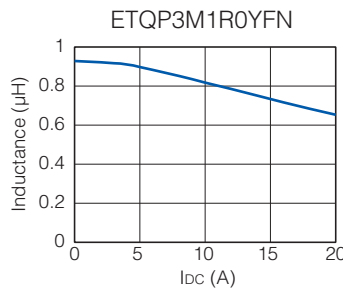
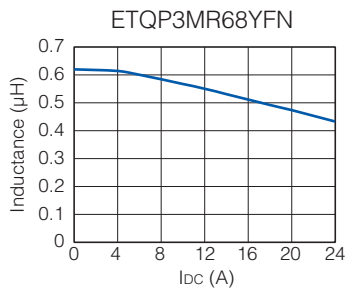

● Case Temperature vs DC Current

PWB condition A : Four-layer PWB (1.6 mm FR4), See also (\*2)

PWB condition B : Multilayer PWB with high heat dissipation performance. See also (\*3)

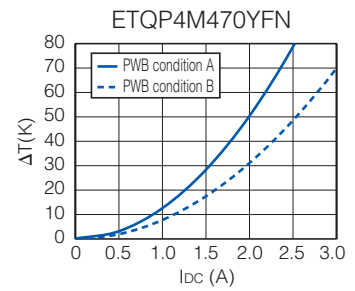
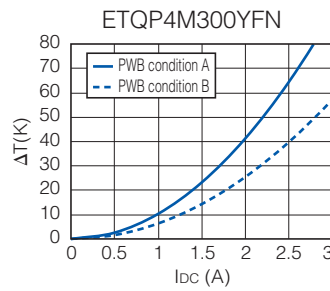
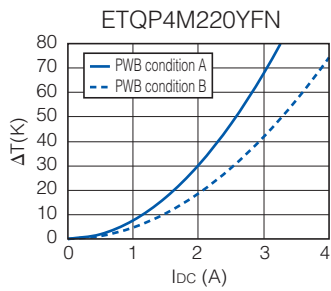
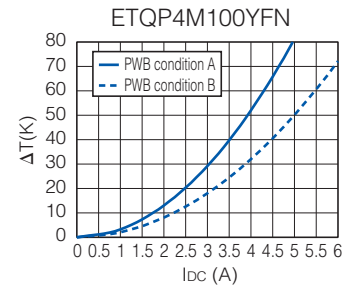
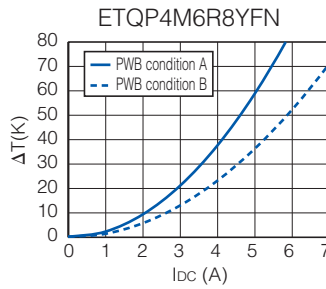
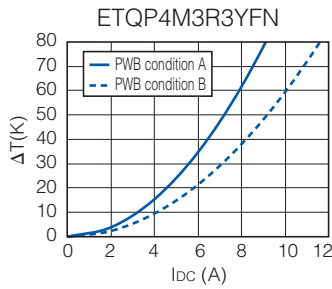
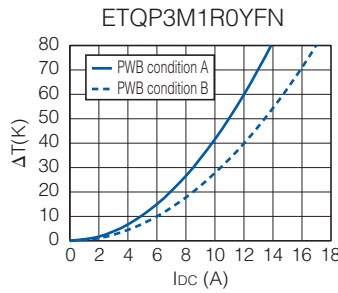
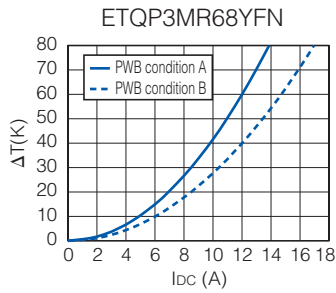

### 3. Series PCC-M0754M/PCC-M0750M (ETQP5M□□□YFM/ETQP5M□□□YGM)

#### Standard Parts

| Series                          | Part No.     | Inductance *1 |               | DCR (at 20 °C) (mΩ) |               | Rated Current (Typ. : A) |      |         |
|---------------------------------|--------------|---------------|---------------|---------------------|---------------|--------------------------|------|---------|
|                                 |              | L0 (μH)       | Tolerance (%) | Typ. (max.)         | Tolerance (%) | ΔT=40K                   |      | ΔL=-30% |
|                                 |              |               |               |                     |               | (*2)                     | (*3) | (*4)    |
| PCC-M0754M<br>[7.5×7.0×5.4(mm)] | ETQP5M4R7YFM | 4.7           | ±20           | 20.00 ( 23.00)      | ±10           | 6.3                      | 8.0  | 13.1    |
|                                 | ETQP5M6R8YFM | 6.8           |               | 26.70 ( 29.40)      |               | 5.5                      | 6.9  | 12.1    |
|                                 | ETQP5M100YFM | 10            |               | 37.60 ( 41.30)      |               | 4.7                      | 5.7  | 10.6    |
|                                 | ETQP5M220YFM | 22            |               | 92.00 (102.00)      |               | 3.0                      | 3.7  | 5.8     |
|                                 | ETQP5M330YFM | 33            |               | 120.00 (132.00)     |               | 2.6                      | 3.3  | 4.8     |
|                                 | ETQP5M470YFM | 48            |               | 156.00 (172.00)     |               | 2.3                      | 2.9  | 4.1     |
| PCC-M0750M<br>[7.5×7.0×5.0(mm)] | ETQP5M101YGM | 95            |               | 348.00 (382.80)     |               | 1.4                      | 1.9  | 3.1     |

(\*1) Measured at 100 kHz.

(\*2) DC current which causes temperature rise of 40 K. Parts are soldered by reflow on four-layer PWB (1.6 mm FR4) and measured at room temperature. See also (\*5)

(\*3) DC current which causes temperature rise of 40 K. Parts are soldered by reflow on multilayer PWB with high heat dissipation performance. Note: Heat radiation constant is approx. 31 K/W measured on 7.5×7.0×5.4 mm case size and approx. 29 K/W measured on 7.5×7.0×5.0 mm case size. See also (\*5)

(\*4) Saturation rated current : DC current which causes L(0) drop -30 %.

(\*5) Within a suitable application, the part's temperature depends on circuit design and certain heat dissipation conditions. This should be double checked in a worst case operation mode.

In normal case, the max.standard operating temperature of +150 °C should not be exceeded.

For higher operating temperature conditions, please contact Panasonic representative in your area.

#### Performance Characteristics (Reference)

##### ● Inductance vs DC Current

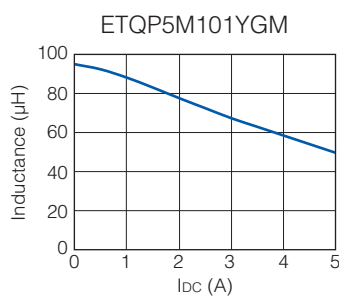
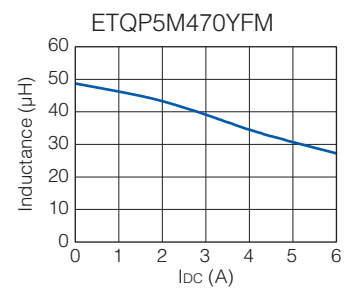
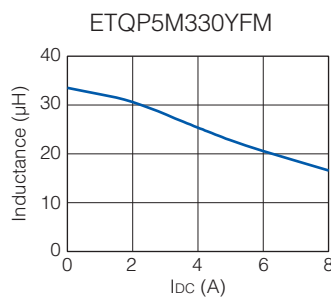
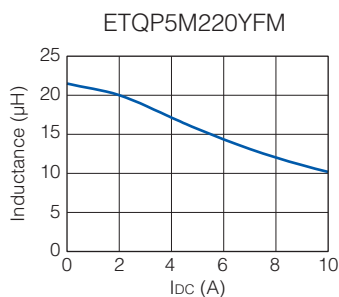
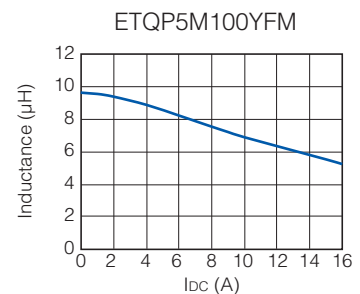
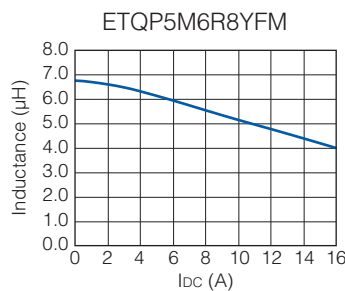
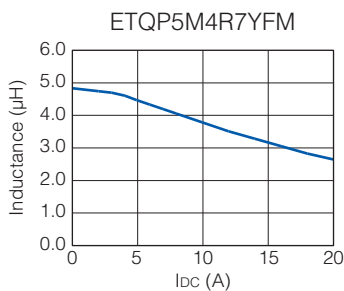

● Case Temperature vs DC Current

PWB condition A : Four-layer PWB (1.6 mm FR4), See also (\*2)

PWB condition B : Multilayer PWB with high heat dissipation performance. See also (\*3)

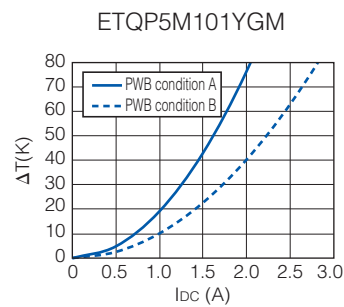
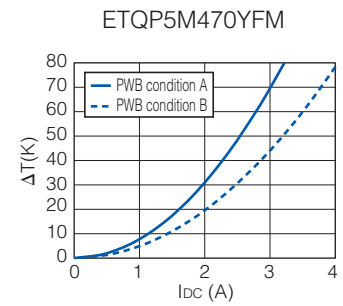
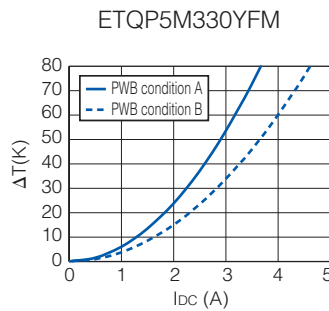
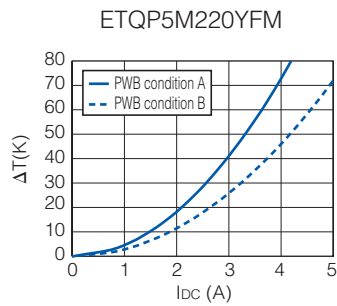
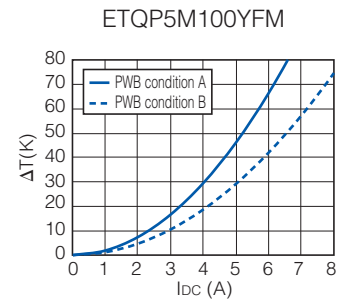
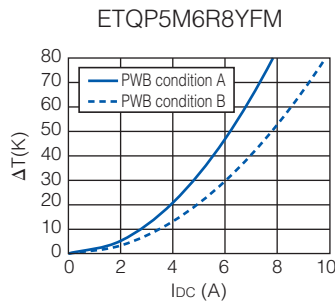
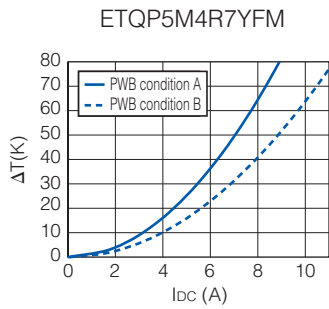

## 4. Series PCC-M0854M/PCC-M0850M (ETQP5M□□□YFK/ETQP5M□□□YGK)

| Standard Parts                  |              | Inductance *1 |               |                 | DCR (at 20 °C) (mΩ) |        | Rated Current (Typ. : A) |              |  |
|---------------------------------|--------------|---------------|---------------|-----------------|---------------------|--------|--------------------------|--------------|--|
| Series                          | Part No.     | L0            | Tolerance (%) | Typ. (max.)     | Tolerance (%)       | ΔT=40K |                          | ΔL=-30% (*4) |  |
|                                 |              | (μH)          |               |                 |                     | (*)2   | (*)3                     |              |  |
| PCC-M0854M<br>[8.5×8.0×5.4(mm)] | ETQP5M2R5YFK | 2.5           | ±20           | 7.60 ( 8.40)    | ±10                 | 11.9   | 14.0                     | 20.1         |  |
|                                 | ETQP5M100YFK | 10            |               | 33.00 ( 37.00)  |                     | 5.7    | 6.7                      | 13.0         |  |
|                                 | ETQP5M150YFK | 15            |               | 48.20 ( 53.10)  |                     | 4.7    | 5.5                      | 7.2          |  |
|                                 | ETQP5M220YFK | 22            |               | 63.00 ( 70.00)  |                     | 4.1    | 4.8                      | 6.9          |  |
|                                 | ETQP5M470YFK | 48            |               | 125.00 (138.00) |                     | 2.9    | 3.4                      | 5.4          |  |
| PCC-M0850M<br>[8.5×8.0×5.0(mm)] | ETQP5M101YGK | 100           |               | 302.00 (333.00) |                     | 1.7    | 2.1                      | 3.0          |  |

(\*1) Measured at 100 kHz.

(\*2) DC current which causes temperature rise of 40 K. Parts are soldered by reflow on four-layer PWB (1.6 mm FR4) and measured at room temperature. See also (\*5)

(\*3) DC current which causes temperature rise of 40 K. Parts are soldered by reflow on multilayer PWB with high heat dissipation performance. Note: Heat radiation constant are approx. 27 K/W measured on 8.5×8.0×5.4 mm case size and approx. 29 K/W measured on 8.5×8.0×5.0 mm case size. See also (\*5)

(\*4) Saturation rated current : DC current which causes L(0) drop -30 %.

(\*5) Within a suitable application, the part's temperature depends on circuit design and certain heat dissipation conditions. This should be double checked in a worst case operation mode.

In normal case, the max.standard operating temperature of + 150 °C should not be exceeded.

For higher operating temperature conditions, please contact Panasonic representative in your area.

## Performance Characteristics (Reference)

### ● Inductance vs DC Current

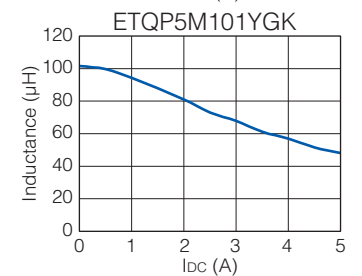
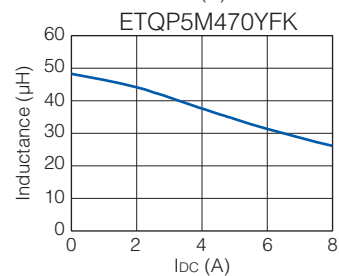
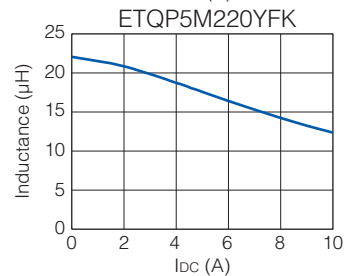
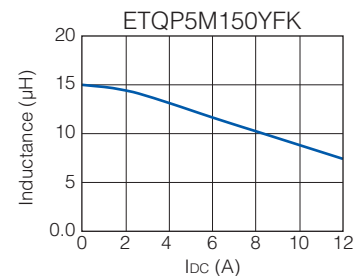
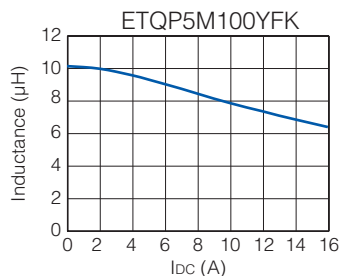
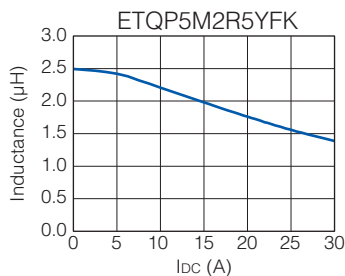

### ● Case Temperature vs DC Current

PWB condition A : Four-layer PWB (1.6 mm FR4), See also (\*2)

PWB condition B : Multilayer PWB with high heat dissipation performance. See also (\*3)

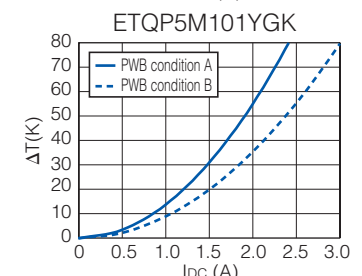
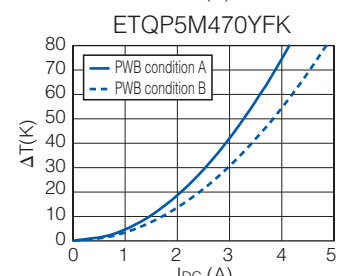
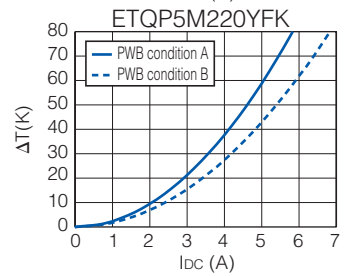
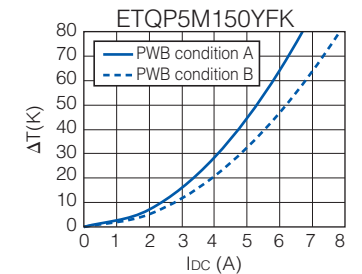
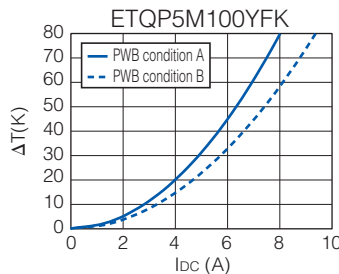
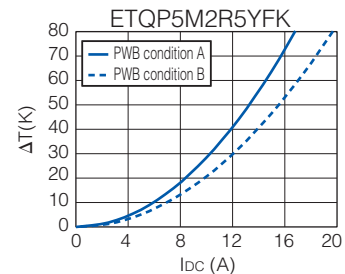

## 5. Series PCC-M1054M/PCC-M1050M (ETQP5M□□□YFC/ETQP5M□□□YGC)

### Standard Parts

| Series                            | Part No.     | Inductance *1 |               | DCR (at 20 °C) (mΩ) |               | Rated Current (Typ. : A) |             |              |
|-----------------------------------|--------------|---------------|---------------|---------------------|---------------|--------------------------|-------------|--------------|
|                                   |              | L0 (μH)       | Tolerance (%) | Typ. (max.)         | Tolerance (%) | ΔT=40K (*2)              | ΔT=40K (*3) | ΔL=-30% (*4) |
| PCC-M1054M<br>[10.7×10.0×5.4(mm)] | ETQP5M1R5YFC | 1.45          | ±20           | 3.80 ( 4.20)        | ±10           | 17.9                     | 21.4        | 35.1         |
|                                   | ETQP5M2R5YFC | 2.5           |               | 5.30 ( 5.90)        |               | 15.1                     | 18.1        | 27.2         |
|                                   | ETQP5M3R3YFC | 3.3           |               | 7.10 ( 7.90)        |               | 13.1                     | 15.7        | 22.7         |
|                                   | ETQP5M4R7YFC | 4.7           |               | 10.20 ( 11.30)      |               | 10.9                     | 13.1        | 20.0         |
|                                   | ETQP5M100YFC | 10            |               | 23.80 ( 26.20)      |               | 7.1                      | 8.5         | 10.7         |
|                                   | ETQP5M150YFC | 15            |               | 35.60 ( 39.16)      |               | 5.8                      | 7.0         | 12.0         |
|                                   | ETQP5M220YFC | 22            |               | 45.00 ( 50.00)      |               | 5.2                      | 6.2         | 8.8          |
|                                   | ETQP5M330YFC | 32.5          |               | 68.50 ( 75.40)      |               | 4.2                      | 5.0         | 7.6          |
|                                   | ETQP5M470YFC | 47            |               | 99.00 (108.90)      |               | 3.5                      | 4.2         | 6.8          |
| PCC-M1050M<br>[10.7×10.0×5.0(mm)] | ETQP5M680YFC | 66            |               | 136.00 (149.60)     |               | 3.0                      | 3.6         | 4.9          |
|                                   | ETQP5M101YGC | 97            |               | 208.00 (229.00)     |               | 2.2                      | 2.7         | 3.0          |

(\*1) Measured at 100 kHz.

(\*2) DC current which causes temperature rise of 40 K. Parts are soldered by reflow on four-layer PWB (1.6 mm FR4) and measured at room temperature. See also (\*5)

(\*3) DC current which causes temperature rise of 40 K. Parts are soldered by reflow on multilayer PWB with high heat dissipation performance. Note: Heat radiation constant are approx. 23 K/W measured on 10.7×10.0×5.4 mm case size and approx. 26 K/W measured on 10.7×10.0×5.0 mm case size. See also (\*5)

(\*4) Saturation rated current : Dc current which causes L(0) drop -30 %.

(\*5) Within a suitable application, the part's temperature depends on circuit design and certain heat dissipation conditions. This should be double checked in a worst case operation mode.

In normal case, the max.standard operating temperature of +150 °C should not be exceeded.

For higher operating temperature conditions, please contact Panasonic representative in your area.

### Performance Characteristics (Reference)

#### ● Inductance vs DC Current

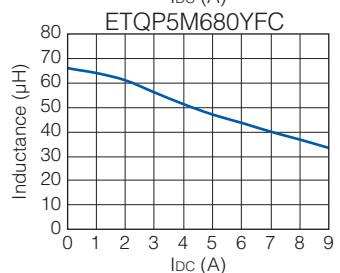
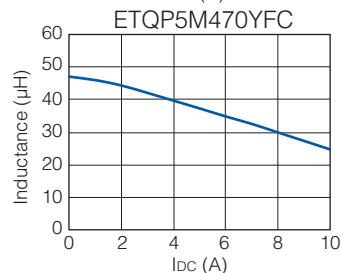
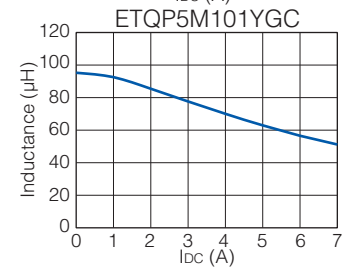
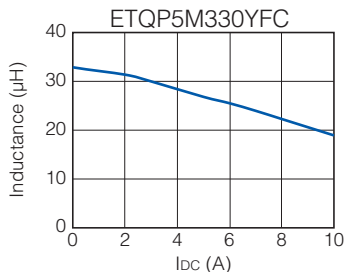
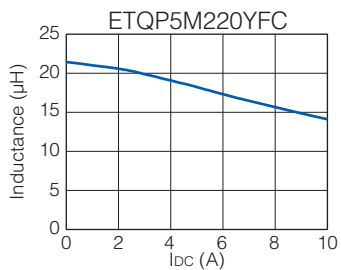
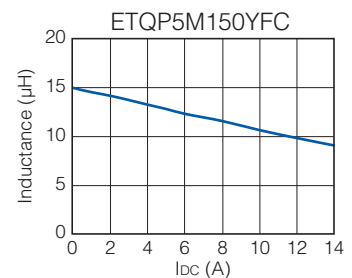
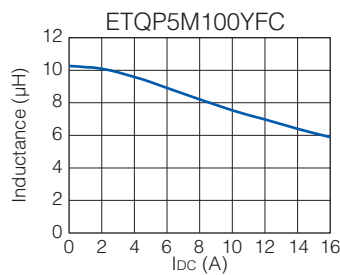
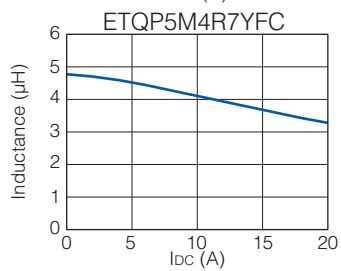
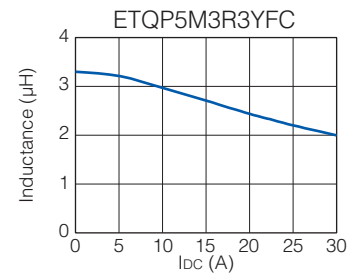
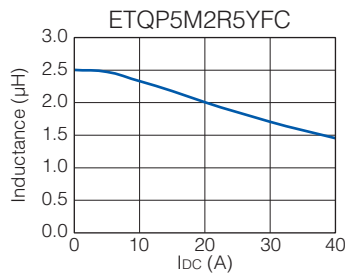
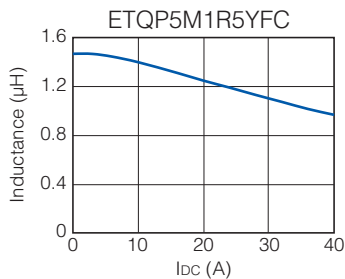



● Case Temperature vs DC Current

PWB condition A : Four-layer PWB (1.6 mm FR4), See also (\*2)

PWB condition B : Multilayer PWB with high heat dissipation performance. See also (\*3)

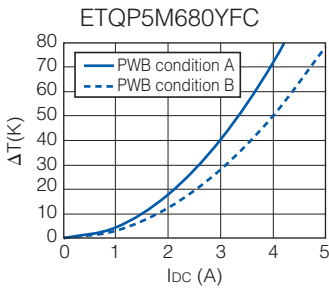
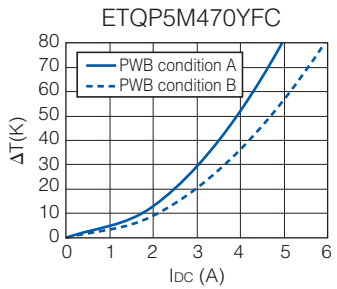
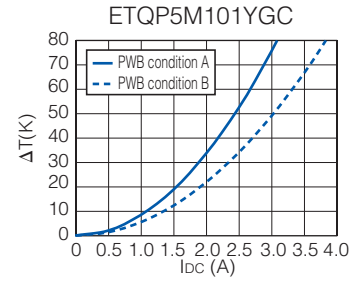
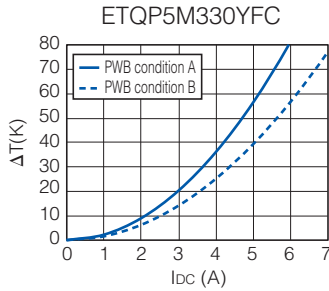
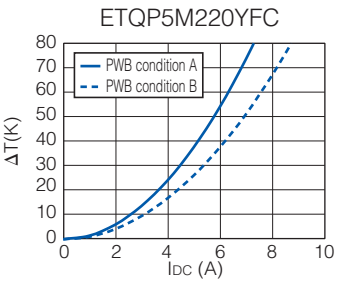
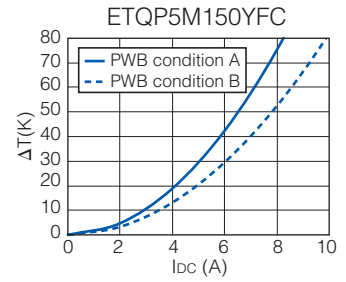
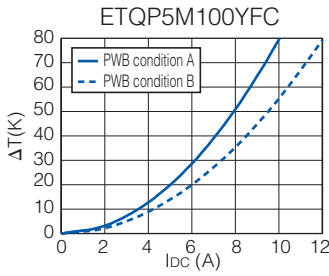
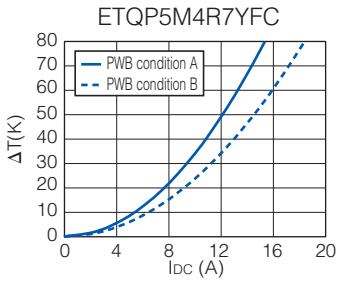
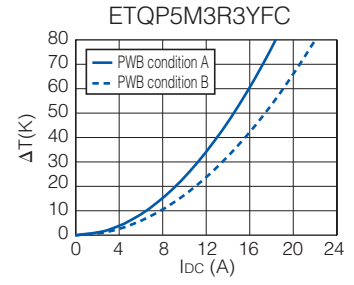
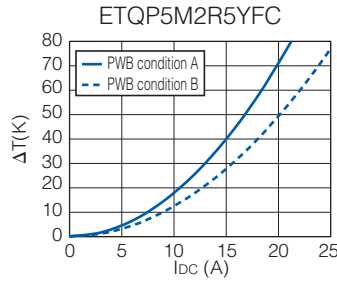
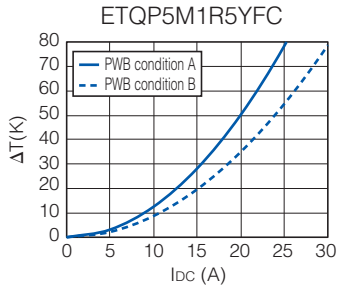

## 6. Series PCC-M1050ML/PCC-M1060ML (ETQP5M□□□YLC/ETQP6M□□□YLC)

### Standard Parts

| Series                             | Part No.     | Inductance *1 |                  | DCR (at 20 °C) (mΩ) |                  | Rated Current (Typ. : A) |      |                 |
|------------------------------------|--------------|---------------|------------------|---------------------|------------------|--------------------------|------|-----------------|
|                                    |              | L0<br>(μH)    | Tolerance<br>(%) | Typ.<br>(max.)      | Tolerance<br>(%) | ΔT=40K                   |      |                 |
|                                    |              |               |                  |                     |                  | (*2)                     | (*3) | ΔL=-30%<br>(*4) |
| PCC-M1050ML<br>[10.9×10.0×5.0(mm)] | ETQP5MR33YLC | 0.33          | ±20              | 1.10 (1.21)         | ±10              | 33.2                     | 39.7 | 56.7            |
|                                    | ETQP5MR68YLC | 0.68          |                  | 1.75 (1.93)         |                  | 26.3                     | 31.5 | 40.0            |
|                                    | ETQP5M1R0YLC | 1.0           |                  | 2.30 (2.53)         |                  | 23.0                     | 27.5 | 37.8            |
|                                    | ETQP5M2R0YLC | 2.0           |                  | 4.60 (5.06)         |                  | 16.2                     | 19.4 | 31.3            |
| PCC-M1060ML<br>[10.9×10.0×6.0(mm)] | ETQP6M1R5YLC | 1.5           | ±20              | 3.20 (3.52)         | ±10              | 19.5                     | 23.3 | 32.0            |
|                                    | ETQP6M2R5YLC | 2.5           |                  | 4.55 (5.00)         |                  | 16.3                     | 19.6 | 25.8            |
|                                    | ETQP6M3R3YLC | 3.3           |                  | 6.00 (6.60)         |                  | 14.2                     | 17.0 | 26.3            |
|                                    | ETQP6M4R7YLC | 4.7           |                  | 8.70 (9.57)         |                  | 11.8                     | 14.1 | 22.5            |

(\*1) Measured at 100 kHz.

(\*2) DC current which causes temperature rise of 40 K. Parts are soldered by reflow on four-layer PWB (1.6 mm FR4) and measured at room temperature. See also (\*5)

(\*3) DC current which causes temperature rise of 40 K. Parts are soldered by reflow on multilayer PWB with high heat dissipation performance. Note: Heat radiation constant are approx. 23 K/W measured on 10.9×10.0×5.0 mm case size and approx. 23 K/W measured on 10.9×10.0×6.0 mm case size. See also (\*5)

(\*4) Saturation rated current : Dc current which causes L(0) drop -30 %.

(\*5) Within a suitable application, the part's temperature depends on circuit design and certain heat dissipation conditions. This should be double checked in a worst case operation mode.

In normal case, the max.standard operating temperature of +150 °C should not be exceeded.

For higher operating temperature conditions, please contact Panasonic representative in your area.

### Performance Characteristics (Reference)

#### ● Inductance vs DC Current

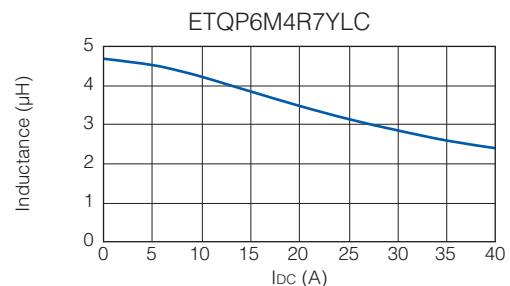
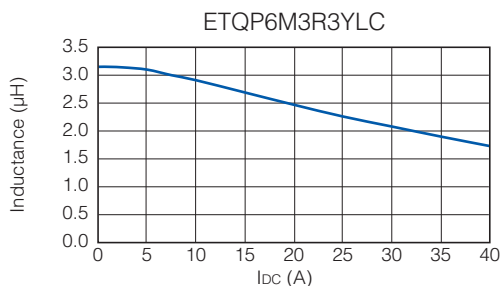
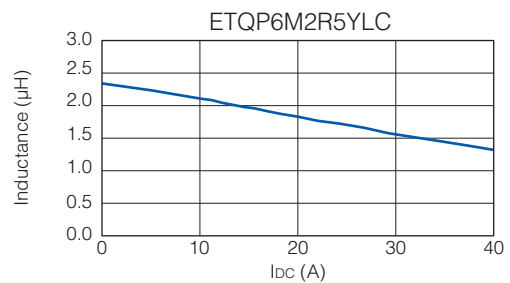
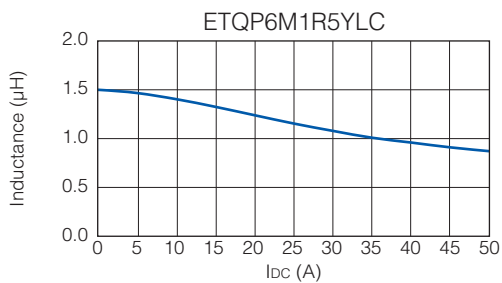
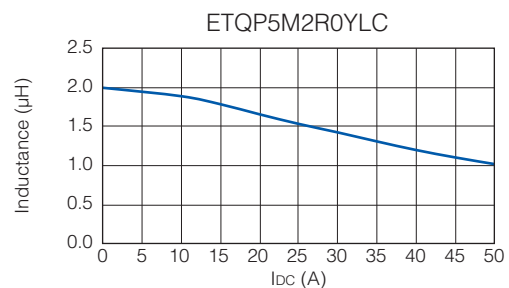
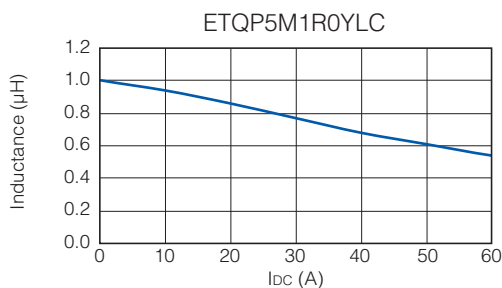
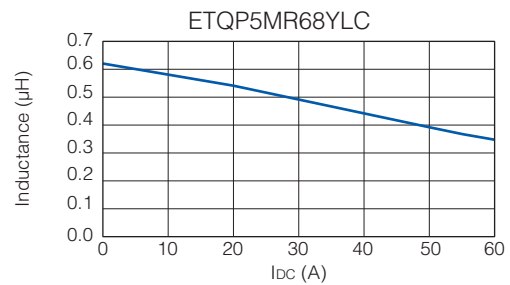
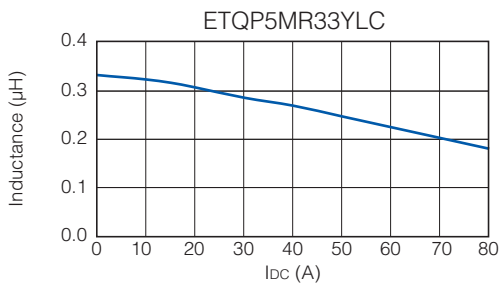

## ● Case Temperature vs DC Current

PWB condition A : Four-layer PWB (1.6 mm FR4), See also (\*2)

PWB condition B : Multilayer PWB with high heat dissipation performance. See also (\*3)

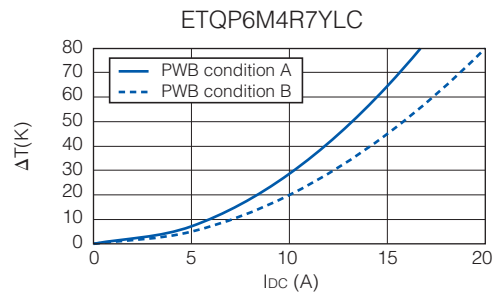
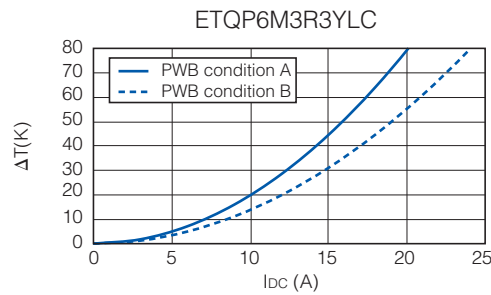
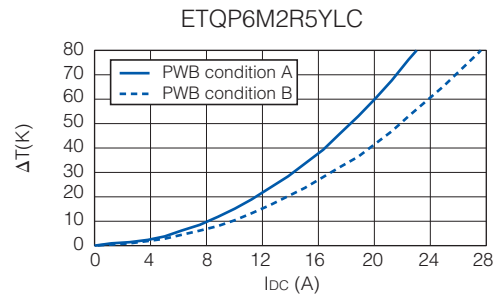
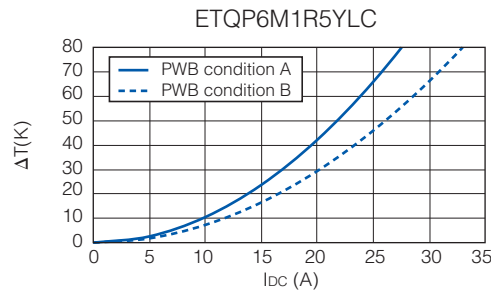
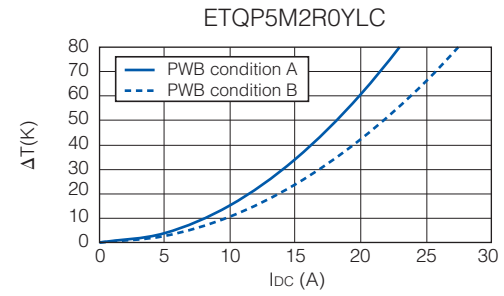
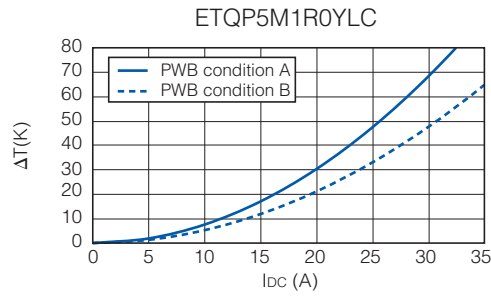
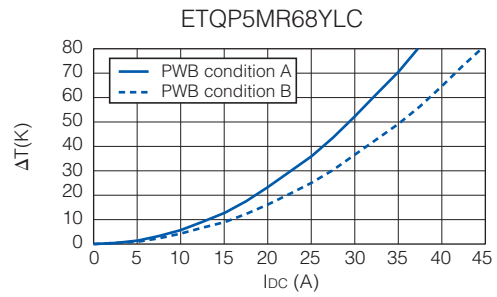
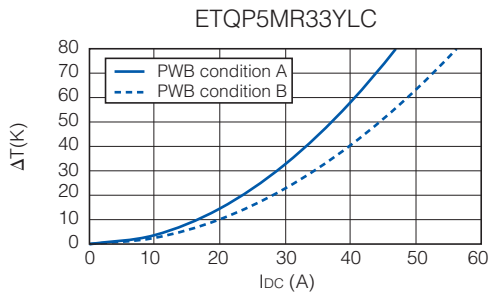

## Dimensions in mm (not to scale)

Dimensional tolerance unless noted :  $\pm 0.5$

Series PCC-M0530M  
Series PCC-M0540M  
(ETQP3M□□□YFP/ETQP4M□□□YFP)

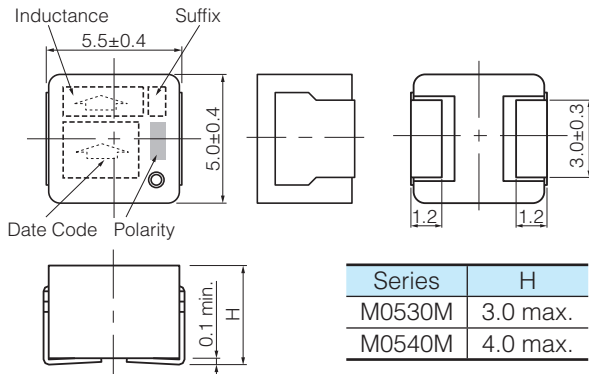

Series PCC-M0630M  
Series PCC-M0645M  
(ETQP3M□□□YFN/ETQP4M□□□YFN)

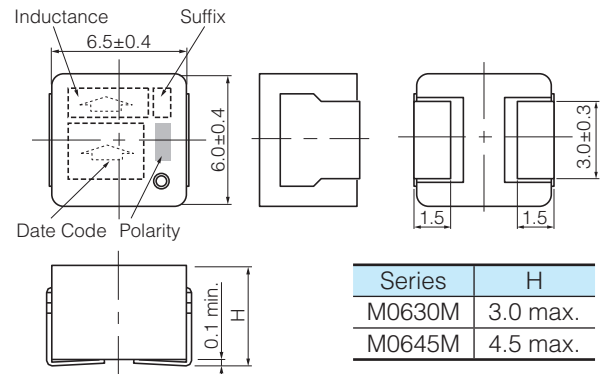

Series PCC-M0754M  
Series PCC-M0750M  
(ETQP5M□□□YFM/YGM)

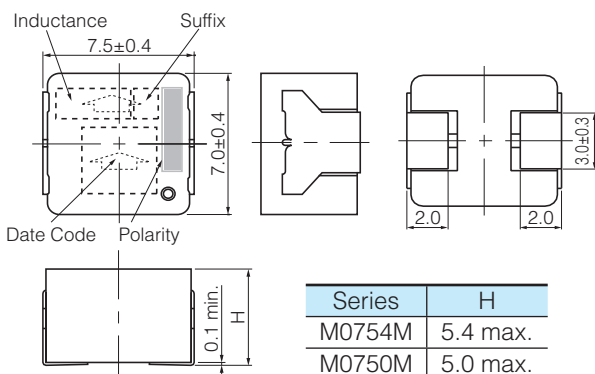

Series PCC-M0854M  
Series PCC-M0850M  
(ETQP5M□□□YFK/YGK)

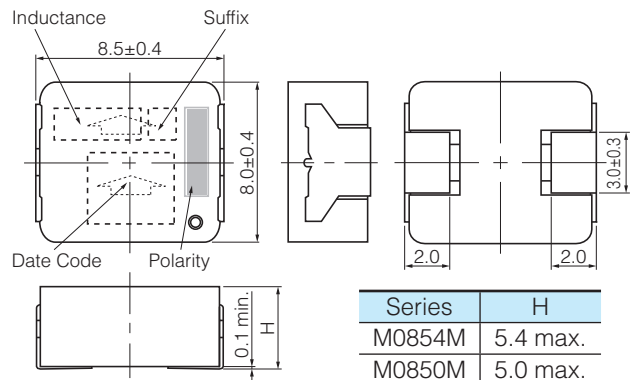

Series PCC-M1054M  
Series PCC-M1050M  
(ETQP5M□□□YFC/YGC)

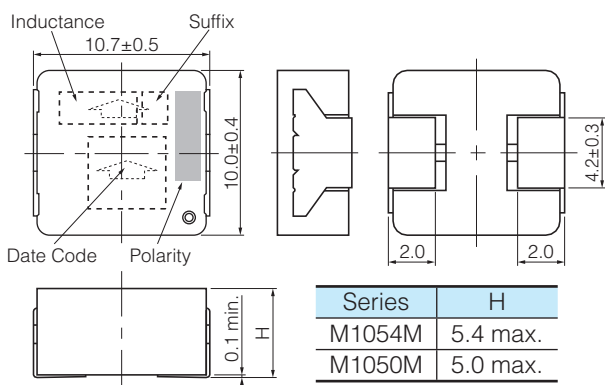

Series PCC-M1050ML  
Series PCC-M1060ML  
(ETQP5M□□□YLC/ETQP6M□□□YLC)

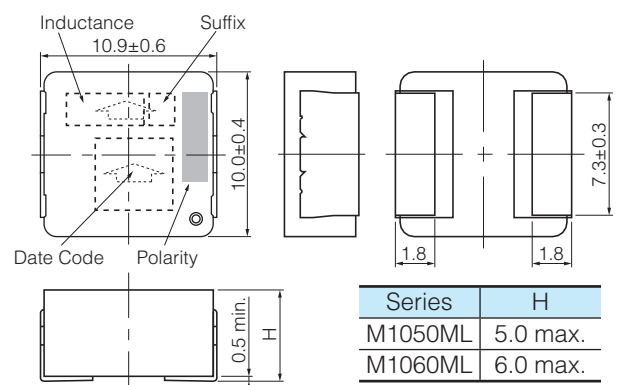

## Recommended Land Pattern in mm (not to scale)

Dimensional tolerance unless noted :  $\pm 0.5$

Series PCC-M0530M  
Series PCC-M0540M  
(ETQP3M□□□YFP/ETQP4M□□□YFP)

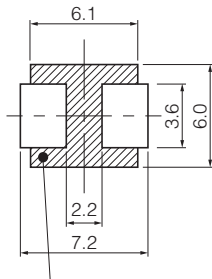

Don't wire on the pattern on shaded portion the PWB.

Series PCC-M0630M  
Series PCC-M0645M  
(ETQP3M□□□YFN/ETQP4M□□□YFN)

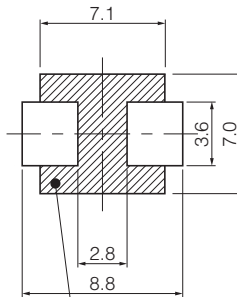

The same as the left.

Series PCC-M0754M  
Series PCC-M0750M  
(ETQP5M□□□YFM/YGM)

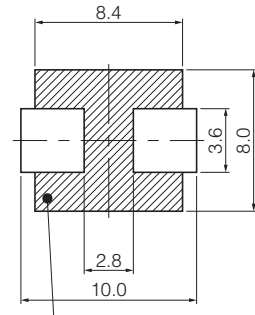

The same as the left.

Series PCC-M0854M  
Series PCC-M0850M  
(ETQP5M□□□YFK/YGK)

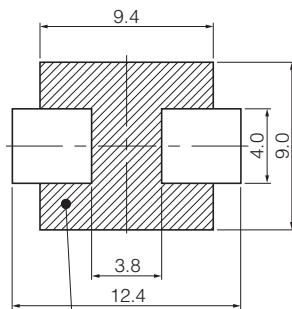

Don't wire on the pattern on shaded portion the PWB.

Series PCC-M1054M  
Series PCC-M1050M  
(ETQP5M□□□YFC/YGC)

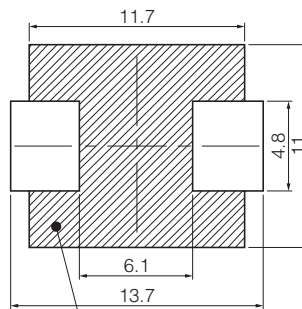

The same as the left.

Series PCC-M1050ML  
Series PCC-M1060ML  
(ETQP5M□□□YLC/ETQP6M□□□YLC)

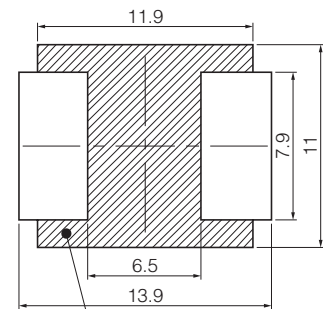

The same as the left.

## ■ As for Soldering Conditions and Safety Precautions (Power Choke Coils (Automotive Grade)),

Please see Data Files

## Packaging Methods (Taping)

- Embossed Carrier Tape Dimensions in mm (not to scale)

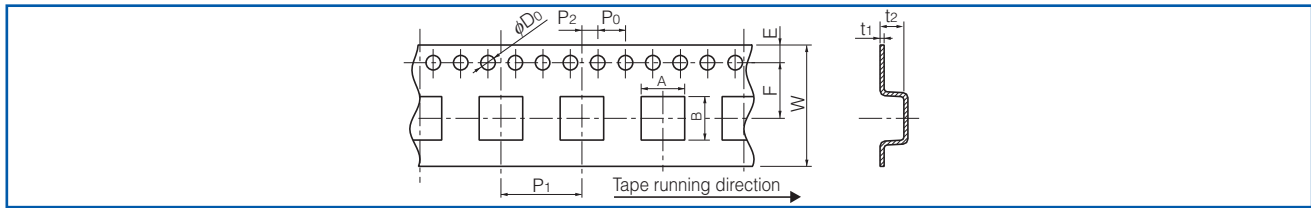

| Series                                   | A    | B    | W    | E    | F    | P <sub>1</sub> | P <sub>2</sub> | P <sub>0</sub> | φD <sub>0</sub> | t <sub>1</sub> | t <sub>2</sub> |
|--|------|------|------|------|------|----------------|----------------|----------------|-----------------|----------------|----------------|
| PCC-M0530M                               | 5.6  | 6.1  | 16.0 | 1.75 | 7.5  | 12.0           | 2.0            | 4.0            | 1.5             | 0.4            | 3.3            |
| PCC-M0540M                               |      |      |      |      |      |                |                |                |                 |                | 4.3            |
| PCC-M0630M                               | 7.1  | 6.6  |      |      |      |                |                |                |                 |                | 3.3            |
| PCC-M0645M                               |      |      |      |      |      |                |                |                |                 |                | 5.0            |
| PCC-M0754M/M0750M                        | 8.1  | 7.6  |      |      |      |                |                |                |                 |                | 6.0            |
| PCC-M0854M/M0850M                        | 9.1  | 8.6  |      |      |      |                |                |                |                 |                | 6.0            |
| PCC-M1054M/M1050M<br>PCC-M1050ML/M1060ML | 10.7 | 11.9 | 24.0 | 11.5 | 16.0 | 0.5            | 6.3            |                |                 |                |                |

- Taping Reel Dimensions in mm (not to scale)

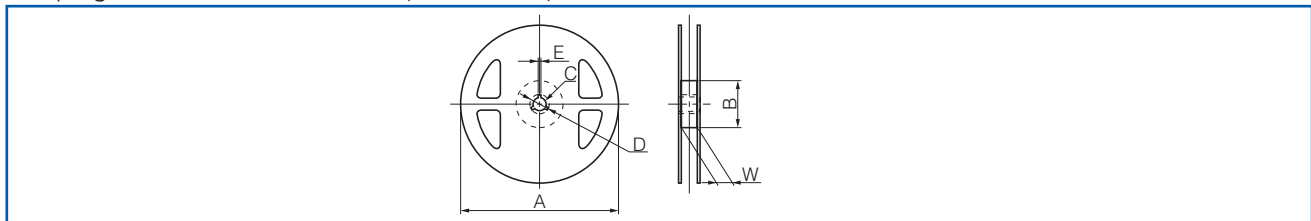

### Standard Reel Dimensions

| Series   | A   | B   | C  | D  | E | W    |
|--|-----|-----|----|----|---|------|
| PCC-M0530M/M0540M<br>PCC-M0630M/M0645M<br>PCC-M0754M/M0750M<br>PCC-M0854M/M0850M | 330 | 100 | 13 | 21 | 2 | 17.5 |
| PCC-M1054M/M1050M<br>PCC-M1050ML/M1060ML   |     |     |    |    |   | 25.5 |

## Component Placement (Taping)

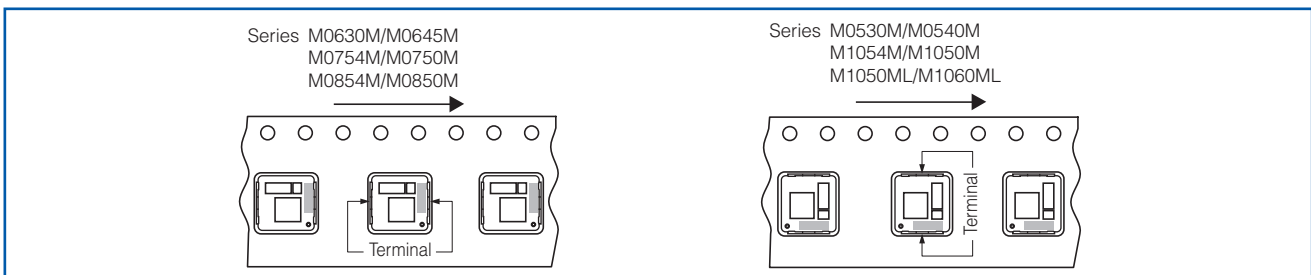

## Standard Packing Quantity/Reel

| Series      | Part No.     | Minimum Quantity / Packing Unit | Quantity per reel |
|-------------|--------------|---------------------------------|-------------------|
| PCC-M0530M  | ETQP3M□□□YFP | 2,000 pcs. / box (2 reel)       | 1,000 pcs.        |
| PCC-M0540M  | ETQP4M□□□YFP |                                 |                   |
| PCC-M0630M  | ETQP3M□□□YFN |                                 |                   |
| PCC-M0645M  | ETQP4M□□□YFN | 1,000 pcs. / box (2 reel)       | 500 pcs.          |
| PCC-M0754M  | ETQP5M□□□YFM |                                 |                   |
| PCC-M0750M  | ETQP5M□□□YGM |                                 |                   |
| PCC-M0854M  | ETQP5M□□□YFK |                                 |                   |
| PCC-M0850M  | ETQP5M□□□YGK |                                 |                   |
| PCC-M1054M  | ETQP5M□□□YFC |                                 |                   |
| PCC-M1050M  | ETQP5M□□□YGC |                                 |                   |
| PCC-M1050ML | ETQP5M□□□YLC |                                 |                   |
| PCC-M1060ML | ETQP6M□□□YLC |                                 |                   |