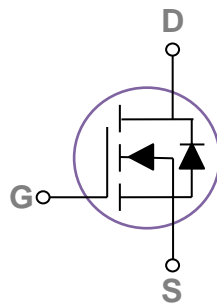
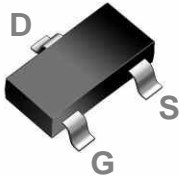


### General Description

These N-Channel enhancement mode power field effect transistors are using trench DMOS technology. This advanced technology has been especially tailored to minimize on-state resistance, provide superior switching performance, and withstand high energy pulse in the avalanche and commutation mode. These devices are well suited for high efficiency fast switching applications.

BVDSS	RDSON	ID
30V	24mΩ	6.5A

### SOT23-3S Pin Configuration



### Features

- 30V, 6.5A,  $R_{DS(ON)} = 24m\Omega$  @  $V_{GS} = 10V$
- Improved  $dv/dt$  capability
- Fast switching
- 100% EAS Guaranteed
- Green Device Available

### Applications

- MB / VGA / Vcore
- Load Switch
- Hand-Held Instrument

### Absolute Maximum Ratings $T_c=25^\circ C$ unless otherwise noted

Symbol	Parameter	Rating	Units
$V_{DS}$	Drain-Source Voltage	30	V
$V_{GS}$	Gate-Source Voltage	$\pm 20$	V
$I_D$	Drain Current – Continuous ( $T_c=25^\circ C$ )	6.5	A
	Drain Current – Continuous ( $T_c=100^\circ C$ )	4.1	A
$I_{DM}$	Drain Current – Pulsed <sup>1</sup>	26	A
EAS	Single Pulse Avalanche Energy <sup>2</sup>	32	mJ
IAS	Single Pulse Avalanche Current <sup>2</sup>	8	A
$P_D$	Power Dissipation ( $T_c=25^\circ C$ )	1.56	W
	Power Dissipation – Derate above $25^\circ C$	0.012	W/ $^\circ C$
$T_{STG}$	Storage Temperature Range	-55 to 150	$^\circ C$
$T_J$	Operating Junction Temperature Range	-55 to 150	$^\circ C$

### Thermal Characteristics

Symbol	Parameter	Typ.	Max.	Unit
$R_{\theta JA}$	Thermal Resistance Junction to ambient	---	80	$^\circ C/W$

**Electrical Characteristics (T<sub>J</sub>=25 °C, unless otherwise noted)**
**Off Characteristics**

Symbol	Parameter	Conditions	Min.	Typ.	Max.	Unit
BV <sub>DSS</sub>	Drain-Source Breakdown Voltage	V <sub>GS</sub> =0V, I <sub>D</sub> =250uA	30	---	---	V
ΔBV <sub>DSS</sub> /ΔT <sub>J</sub>	BV <sub>DSS</sub> Temperature Coefficient	Reference to 25°C, I <sub>D</sub> =1mA	---	0.04	---	V/°C
I <sub>DSS</sub>	Drain-Source Leakage Current	V <sub>DS</sub> =30V, V <sub>GS</sub> =0V, T <sub>J</sub> =25°C	---	---	1	uA
		V <sub>DS</sub> =24V, V <sub>GS</sub> =0V, T <sub>J</sub> =125°C	---	---	10	uA
I <sub>GSS</sub>	Gate-Source Leakage Current	V <sub>GS</sub> =±20V, V <sub>DS</sub> =0V	---	---	±100	nA

**On Characteristics**

R <sub>DS(ON)</sub>	Static Drain-Source On-Resistance <sup>3</sup>	V <sub>GS</sub> =10V, I <sub>D</sub> =6A	---	20	24	mΩ
		V <sub>GS</sub> =4.5V, I <sub>D</sub> =4A	---	27	34	mΩ
V <sub>GS(th)</sub>	Gate Threshold Voltage	V <sub>GS</sub> =V <sub>DS</sub> , I <sub>D</sub> =250uA	1.2	1.6	2.5	V
ΔV <sub>GS(th)</sub>	V <sub>GS(th)</sub> Temperature Coefficient		---	-4	---	mV/°C
g <sub>fs</sub>	Forward Transconductance	V <sub>DS</sub> =10V, I <sub>D</sub> =4A	---	6.5	---	S

**Dynamic and switching Characteristics**

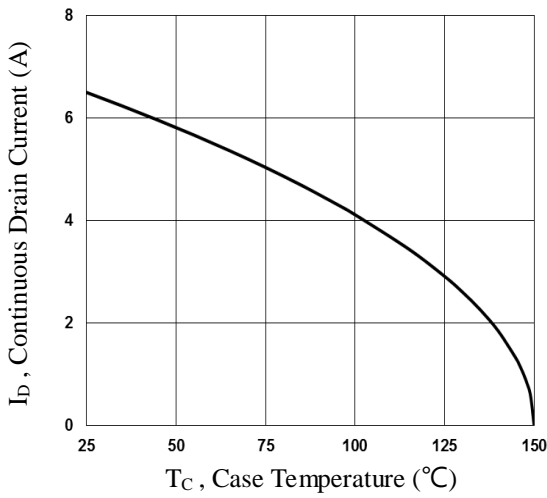
Q <sub>g</sub>	Total Gate Charge <sup>3,4</sup>	V <sub>DS</sub> =15V, V <sub>GS</sub> =4.5V, I <sub>D</sub> =6A	---	4.1	8	nC
Q <sub>gs</sub>	Gate-Source Charge <sup>3,4</sup>		---	1	2	
Q <sub>gd</sub>	Gate-Drain Charge <sup>3,4</sup>		---	2.1	4	
T <sub>d(on)</sub>	Turn-On Delay Time <sup>3,4</sup>	V <sub>DD</sub> =15V, V <sub>GS</sub> =10V, R <sub>G</sub> =6Ω I <sub>D</sub> =1A	---	2.8	5	ns
T <sub>r</sub>	Rise Time <sup>3,4</sup>		---	7.2	14	
T <sub>d(off)</sub>	Turn-Off Delay Time <sup>3,4</sup>		---	15.8	30	
T <sub>f</sub>	Fall Time <sup>3,4</sup>		---	4.6	9	
C <sub>iss</sub>	Input Capacitance	V <sub>DS</sub> =25V, V <sub>GS</sub> =0V, F=1MHz	---	345	500	pF
C <sub>oss</sub>	Output Capacitance		---	55	80	
C <sub>riss</sub>	Reverse Transfer Capacitance		---	32	45	
R <sub>g</sub>	Gate resistance		V <sub>GS</sub> =0V, V <sub>DS</sub> =0V, F=1MHz	---	3.2	

**Drain-Source Diode Characteristics and Maximum Ratings**

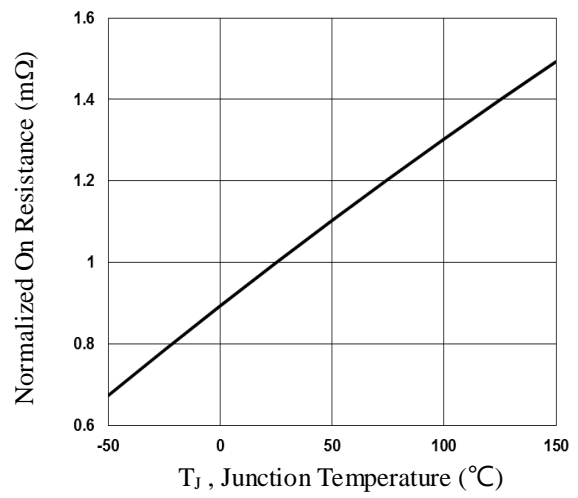
Symbol	Parameter	Conditions	Min.	Typ.	Max.	Unit
I <sub>S</sub>	Continuous Source Current	V <sub>G</sub> =V <sub>D</sub> =0V, Force Current	---	---	6.5	A
I <sub>SM</sub>	Pulsed Source Current <sup>3</sup>		---	---	26	A
V <sub>SD</sub>	Diode Forward Voltage <sup>3</sup>	V <sub>GS</sub> =0V, I <sub>S</sub> =1A, T <sub>J</sub> =25°C	---	---	1	V
t <sub>rr</sub>	Reverse Recovery Time	V <sub>GS</sub> =0V, I <sub>S</sub> =1A, di/dt=100A/μs	---	---	---	ns
Q <sub>rr</sub>	Reverse Recovery Charge	T <sub>J</sub> =25°C	---	---	---	nC

Note :

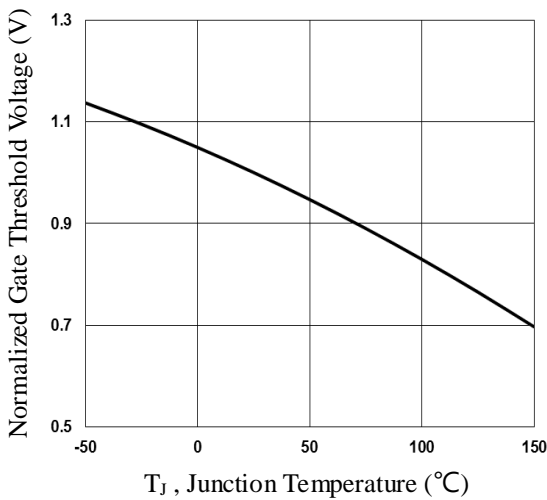
1. Repetitive Rating : Pulsed width limited by maximum junction temperature.
2. V<sub>DD</sub>=25V, V<sub>GS</sub>=10V, L=1mH, I<sub>AS</sub>=8A., R<sub>G</sub>=25Ω, Starting T<sub>J</sub>=25°C.
3. The data tested by pulsed, pulse width ≤ 300us, duty cycle ≤ 2%.
4. Essentially independent of operating temperature.



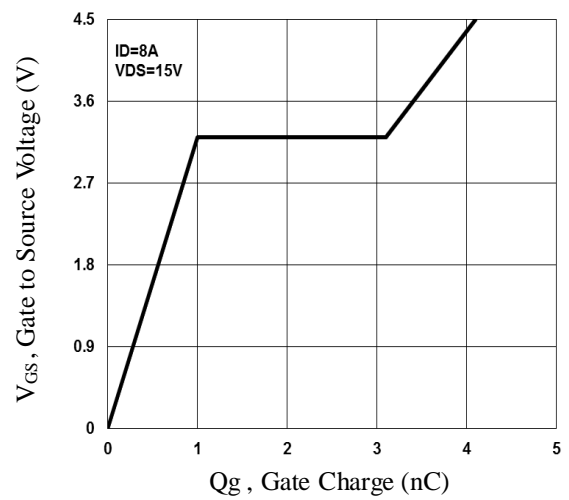
**Fig.1 Continuous Drain Current vs.  $T_c$**



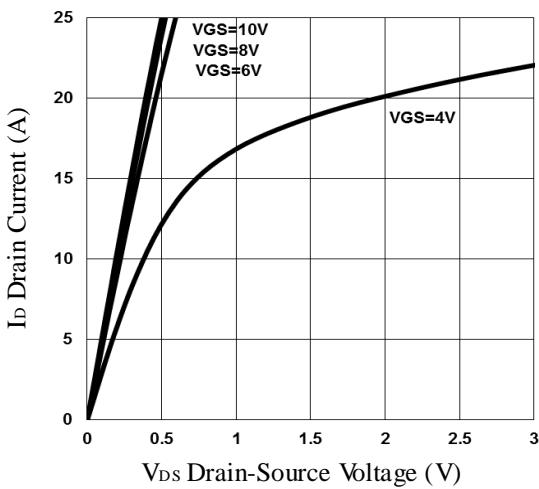
**Fig.2 Normalized  $R_{DSon}$  vs.  $T_j$**



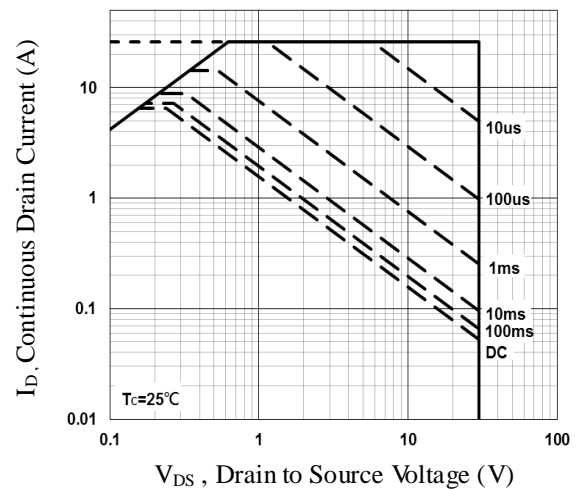
**Fig.3 Normalized  $V_{th}$  vs.  $T_j$**



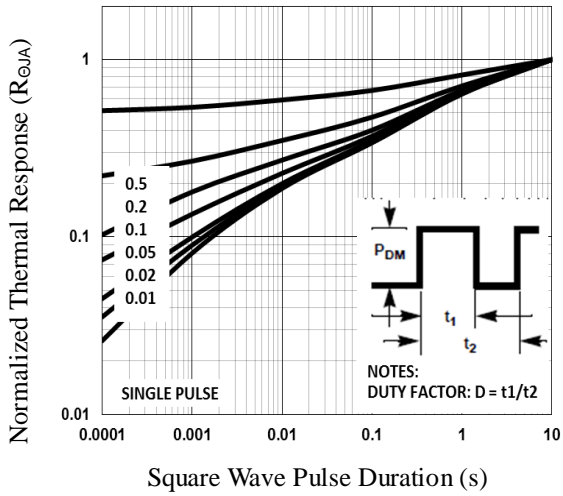
**Fig.4 Gate Charge Waveform**



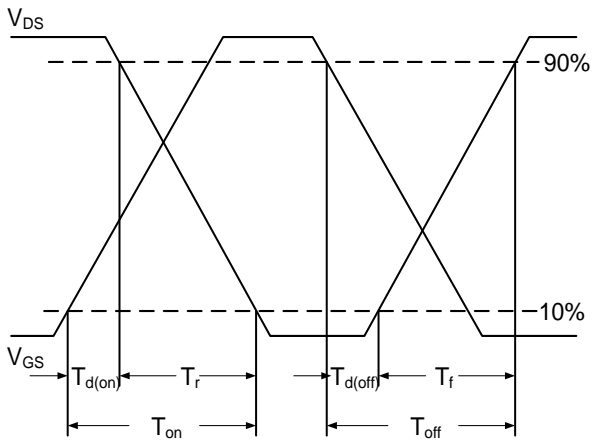
**Fig.5 On Region Characteristics**



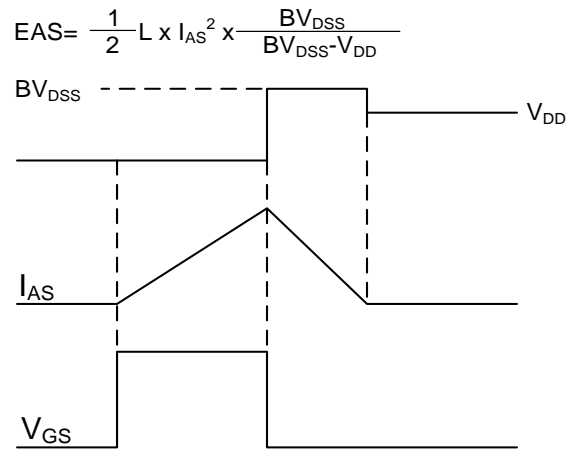
**Fig.6 Maximum Safe Operation Area**



**Fig.7 Normalized Transient Response**

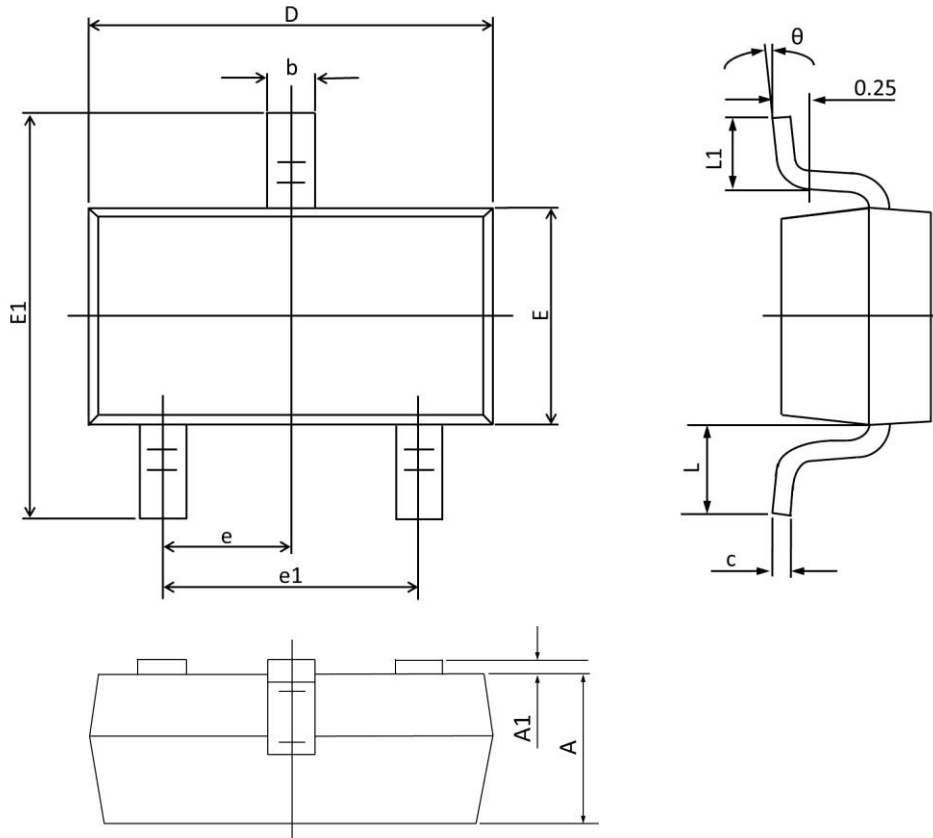


**Fig.8 Switching Time Waveform**



**Fig.9 EAS Waveform**

**SOT23-3S PACKAGE INFORMATION**



Symbol	Dimensions In Millimeters		Dimensions In Inches	
	Min	Max	Min	Max
A	0.900	1.000	0.035	0.039
A1	0.000	0.100	0.000	0.004
b	0.300	0.500	0.012	0.020
c	0.090	0.110	0.003	0.004
D	2.800	3.000	0.110	0.118
E	1.200	1.400	0.047	0.055
E1	2.250	2.550	0.089	0.100
e	0.950 TYP.		0.037 TYP.	
e1	1.800	2.000	0.071	0.079
L	0.550 REF.		0.022 REF.	
L1	0.300	0.500	0.012	0.020
$\theta$	1°	7°	1°	7°