

Applications

- WiFi bandpass filter that enables the coexistence of 3G/4G/LTE/TD-LTE & WiFi signals
- High-power WLAN Access Points and Small Cells
- Band-edge filtering of WiFi signal emissions
- Smart Meters and 2.4GHz ISM Applications
- Set Top Box, Gateways and WiFi Routers

Product Features

- Low Loss in WLAN band with extended upper corner for inclusion of Bluetooth
- High Rejection in B38/B40 bands
- Industry leading small size: 1.4 x 1.2 x 0.46 mm
- Performance over -40 to +95 °C
- Ceramic chip-scale Package (CSP)
- Hermetically sealed
- RoHS compliant, Pb-free 

General Description

The 885062 is a high-performance, high power Bulk Acoustic Wave (BAW) band-pass filter with extremely steep skirts, simultaneously exhibiting low loss in the WiFi band and high band-edge & near-in rejection.

The 885062 enables coexistence of WiFi and LTE signals within the same device or in close proximity to one another. Its unique power handling capability allows for implementation into access points, small cell base stations, and other high power ISM band applications.

The 885062 uses common module packaging techniques to achieve the industry standard 1.4 x 1.2 x 0.46 mm footprint. The filter exhibits excellent power handling capabilities.

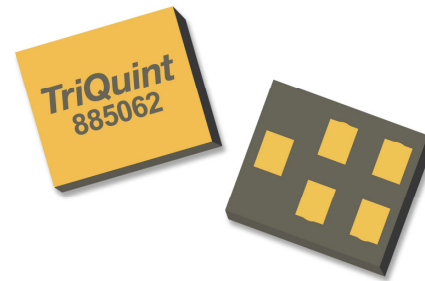

CSP-5CT package: 1.4 x 1.2 x 0.46 mm

Functional Block Diagram

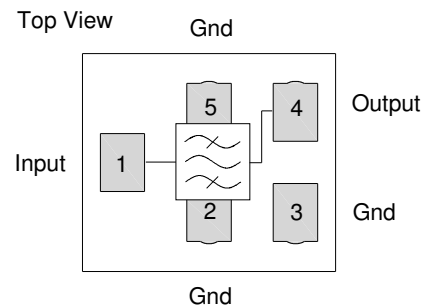

Pin Configuration

Pin No.	Label
1	Input
4	Output
2,3,5	Ground

Ordering Information

Part No.	Description
885062	Packaged part
885062-EVB	Evaluation board

Standard T/R size = 15,000 units/reel

Absolute Maximum Ratings

Parameter	Rating	MTTF			
		Input Power ⁽³⁾	+ 70 °C	+ 85 °C	+ 95 °C
Storage Temperature ⁽¹⁾	-55 to +125 °C				
Operable Temperature ⁽²⁾	-40 to +95 °C	+ 28 dBm	> 14M hours	> 5M hours	> 2M hours

1. Operation of this device outside the parameter ranges given may cause permanent damage.
2. Specifications are not guaranteed over all operable conditions.
3. Input Power with WLAN OFDM signal applied.

Electrical Specifications ⁽¹⁾

Conditions unless otherwise noted: Device Temperature = -30°C to +85°C.

Parameter ⁽²⁾	Conditions	Min	Typ (+25°C)	Max	Units
Insertion Loss ⁽³⁾	2402.5 – 2421.5 MHz (WiFi Ch.1)		1.7	2.2	dB
	2407.5 – 2426.5 MHz (WiFi Ch.2)		1.5	2.0	
	2412.5 – 2471.5 MHz (WiFi Ch.3-11)	-	1.5	1.9	
	2457.5 – 2476.5 MHz (WiFi Ch.12)		1.6	2.1	
	2462.5 – 2481.5 MHz (WiFi Ch.13)		1.7	2.2	
Amplitude Variation	2402.5 – 2421.5 MHz (WiFi Ch.1)		0.8	1.5	dB
	2407.5 – 2426.5 MHz (WiFi Ch.2)		0.8	1.1	
	2412.5 – 2471.5 MHz (WiFi Ch.3-11)	-	0.9	1.1	
	2457.5 – 2476.5 MHz (WiFi Ch.12)		0.4	1.0	
	2462.5 – 2481.5 MHz (WiFi Ch.13)		0.6	1.8	
Input/Output VSWR	2402.5 – 2481.5 MHz (WiFi Ch.1-13)	-	1.9	2.2	-
Impulse Response Length ⁽⁴⁾	2401 – 2483 MHz	-	160	200	ns
	100 – 2300 MHz	35	37	-	dB
Attenuation	2300 – 2365 MHz ⁽⁵⁾	48	53	-	dB
	2365 – 2370 MHz ⁽⁵⁾	54	58	-	dB
	2370 – 2375 MHz (+25 to +85°C) ⁽⁵⁾	45	61	-	dB
	2370 – 2375 MHz (-30 to +25°C) ⁽⁵⁾	56	61	-	dB
	2375 – 2380 MHz (+25 to +85°C) ⁽⁵⁾	25	49	-	dB
	2375 – 2380 MHz (-30 to +25°C) ⁽⁵⁾	34	49	-	dB
	2500 – 2505 MHz (+25 to +85°C) ⁽⁵⁾	29	41	-	dB
	2500 – 2505 MHz (-30 to +25°C) ⁽⁵⁾	20	41	-	dB
	2505 – 2570 MHz (+25 to +85°C) ⁽⁵⁾	49	55	-	dB
	2505 – 2570 MHz (-30 to +25°C) ⁽⁵⁾	38	55	-	dB
	2570 – 2620 MHz ⁽⁵⁾	45	48	-	dB
2620 – 2690 MHz ⁽⁵⁾	44	46	-	dB	
4800 – 5000 MHz	38	43	-	dB	
7200 – 7500 MHz	36	40	-	dB	
2 nd Harmonics	CW Tone = 2442 MHz @ 22.5 dBm	-	60	-	dBc
3 rd Harmonics	CW Tone = 2442 MHz @ 22.5 dBm	-	138	-	dBc

Notes:

1. In production, devices will be tested at room temperature to a guard-banded specification to ensure electrical compliance over temperature.
2. Electrical margin has been built into the design to account for the variations due to temperature drift and manufacturing tolerances.
3. Data is the integrated value of the linear s-parameter over the indicated band at the specified temperature.
4. Duration in ns between the maxima and the point 40 dB below the maxima.
5. Data is the integrated value of the linear s-parameter over 5 MHz range at the specified temperature.
6. An external impedance matching network with $\pm 2\%$ tolerance will be necessary to achieve the stated specifications.
7. This is the optimum impedance in order to achieve the performance shown.

Electrical Specifications ⁽¹⁾

Conditions unless otherwise noted: Device Temperature = -40°C to +95°C.

Parameter ⁽²⁾	Conditions	Min	Typ (+25°C)	Max	Units
Insertion Loss ⁽³⁾	2402.5 – 2421.5 MHz (WiFi Ch.1)	-	1.7	2.2	dB
	2407.5 – 2426.5 MHz (WiFi Ch.2)		1.5	2.0	
	2412.5 – 2471.5 MHz (WiFi Ch.3-11)		1.5	2.1	
	2457.5 – 2476.5 MHz (WiFi Ch.12)		1.6	2.2	
	2462.5 – 2481.5 MHz (WiFi Ch.13)		1.7	2.4	
Amplitude Variation	2402.5 – 2421.5 MHz (WiFi Ch.1)	-	0.8	1.8	dB
	2407.5 – 2426.5 MHz (WiFi Ch.2)		0.8	1.1	
	2412.5 – 2471.5 MHz (WiFi Ch.3-11)		0.9	1.1	
	2457.5 – 2476.5 MHz (WiFi Ch.12)		0.4	1.0	
	2462.5 – 2481.5 MHz (WiFi Ch.13)		0.6	1.8	
Input/Output VSWR	2402.5 – 2481.5 MHz (WiFi Ch.1-13)	-	1.9	2.2	-
Impulse Response Length ⁽⁴⁾	2401 – 2483 MHz	-	160	200	ns
Attenuation	100 – 2300 MHz	35	37	-	dB
	2300 – 2365 MHz ⁽⁵⁾	48	53	-	dB
	2365 – 2370 MHz ⁽⁵⁾	54	58	-	dB
	2370 – 2375 MHz (+25 to +95°C) ⁽⁵⁾	43	61	-	dB
	2370 – 2375 MHz (-40 to +25°C) ⁽⁵⁾	56	61	-	dB
	2375 – 2380 MHz (+25 to +95°C) ⁽⁵⁾	23	49	-	dB
	2375 – 2380 MHz (-40 to +25°C) ⁽⁵⁾	34	49	-	dB
	2500 – 2505 MHz (+25 to +95°C) ⁽⁵⁾	29	41	-	dB
	2500 – 2505 MHz (-40 to +25°C) ⁽⁵⁾	18	41	-	dB
	2505 – 2570 MHz (+25 to +95°C) ⁽⁵⁾	49	55	-	dB
	2505 – 2570 MHz (-40 to +25°C) ⁽⁵⁾	35	55	-	dB
	2570 – 2620 MHz ⁽⁵⁾	45	48	-	dB
2620 – 2690 MHz ⁽⁵⁾	44	46	-	dB	
4800 – 5000 MHz	38	43	-	dB	
7200 – 7500 MHz	36	40	-	dB	
2 nd Harmonics	CW Tone = 2442 MHz @ 22.5 dBm	-	60	-	dBc
3 rd Harmonics	CW Tone = 2442 MHz @ 22.5 dBm	-	138	-	dBc

Notes:

1. In production, devices will be tested at room temperature to a guard-banded specification to ensure electrical compliance over temperature.
2. Electrical margin has been built into the design to account for the variations due to temperature drift and manufacturing tolerances.
3. Data is the integrated value of the linear s-parameter over the indicated band at the specified temperature.
4. Duration in ns between the maxima and the point 40 dB below the maxima.
5. Data is the integrated value of the linear s-parameter over 5 MHz range at the specified temperature.
6. An external impedance matching network with $\pm 2\%$ tolerance will be necessary to achieve the stated specifications.
7. This is the optimum impedance in order to achieve the performance shown.

Electrical Specifications ⁽¹⁾

Conditions unless otherwise noted: Device Temperature = 0°C to +70°C.

Parameter ⁽²⁾	Conditions	Min	Typ (+25°C)	Max	Units
Insertion Loss ⁽³⁾	2402.5 – 2421.5 MHz (WiFi Ch.1)	-	1.7	2.2	dB
	2407.5 – 2426.5 MHz (WiFi Ch.2)		1.5	2.0	
	2412.5 – 2471.5 MHz (WiFi Ch.3-11)		1.5	1.9	
	2457.5 – 2476.5 MHz (WiFi Ch.12)		1.6	2.1	
	2462.5 – 2481.5 MHz (WiFi Ch.13)		1.7	2.2	
Amplitude Variation	2402.5 – 2421.5 MHz (WiFi Ch.1)	-	0.8	1.5	dB
	2407.5 – 2426.5 MHz (WiFi Ch.2)		0.8	1.1	
	2412.5 – 2471.5 MHz (WiFi Ch.3-11)		0.9	1.1	
	2457.5 – 2476.5 MHz (WiFi Ch.12)		0.4	1.0	
	2462.5 – 2481.5 MHz (WiFi Ch.13)		0.6	1.6	
Input/Output VSWR	2402.5 – 2481.5 MHz (WiFi Ch.1-13)	-	1.9	2.2	-
Impulse Response Length ⁽⁴⁾	2401 – 2483 MHz	-	160	200	ns
Attenuation	100 – 2300 MHz	35	37	-	dB
	2300 – 2365 MHz ⁽⁵⁾	48	53	-	dB
	2365 – 2370 MHz ⁽⁵⁾	54	58	-	dB
	2370 – 2375 MHz (+25 to +70°C) ⁽⁵⁾	46	61	-	dB
	2370 – 2375 MHz (0 to +25°C) ⁽⁵⁾	56	61	-	dB
	2375 – 2380 MHz (+25 to +70°C) ⁽⁵⁾	27	49	-	dB
	2375 – 2380 MHz (0 to +25°C) ⁽⁵⁾	34	49	-	dB
	2500 – 2505 MHz (+25 to +70°C) ⁽⁵⁾	29	41	-	dB
	2500 – 2505 MHz (0 to +25°C) ⁽⁵⁾	26	41	-	dB
	2505 – 2570 MHz (+25 to +70°C) ⁽⁵⁾	49	55	-	dB
	2505 – 2570 MHz (0 to +25°C) ⁽⁵⁾	40	55	-	dB
	2570 – 2620 MHz ⁽⁵⁾	45	48	-	dB
	2620 – 2690 MHz ⁽⁵⁾	44	46	-	dB
4800 – 5000 MHz	38	43	-	dB	
7200 – 7500 MHz	36	40	-	dB	
2 nd Harmonics	CW Tone = 2442 MHz @ 22.5 dBm	-	60	-	dBc
3 rd Harmonics	CW Tone = 2442 MHz @ 22.5 dBm	-	138	-	dBc

Notes:

- In production, devices will be tested at room temperature to a guard-banded specification to ensure electrical compliance over temperature.
- Electrical margin has been built into the design to account for the variations due to temperature drift and manufacturing tolerances.
- Data is the integrated value of the linear s-parameter over the indicated band at the specified temperature.
- Duration in ns between the maxima and the point 40 dB below the maxima.
- Data is the integrated value of the linear s-parameter over 5 MHz range at the specified temperature.
- An external impedance matching network with $\pm 2\%$ tolerance will be necessary to achieve the stated specifications.
- This is the optimum impedance in order to achieve the performance shown.

Evaluation Board

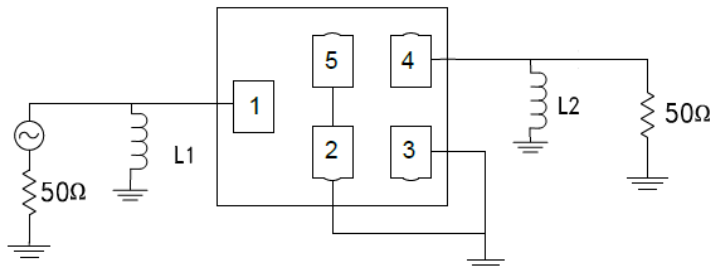
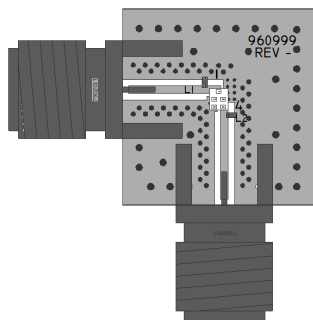

Notes:

1. Matching component values shown are for the specified TriQuint evaluation board. Value adjustment may be required in end user product circuits depending on component manufacturer and PCB material.
2. PCB: .500 x.500 x .062; Construction: ½ oz Cu Top Layer; TLY-5A (.0075) ½ oz Cu Middle Layer, FR4; ½ oz Cu Bottom Layer. (dimensions are in inches)

Bill of Material

Reference Des.	Value	Description	Manuf.	Part Number
L1	9.1 nH	Chip Inductor, 0201, +/- 2 %	Murata	LQP03TN9N1J02
L2	6.8 nH	Chip Inductor, 0201, +/- 2 %	Murata	LQP03TN6N8J02
SMA	N/A	SMA connector	Radiall USA	9602-1111-018
PCB	N/A	3-layer	Multiple	960999

Performance Plots

Test conditions unless otherwise noted: Temp= +25°C

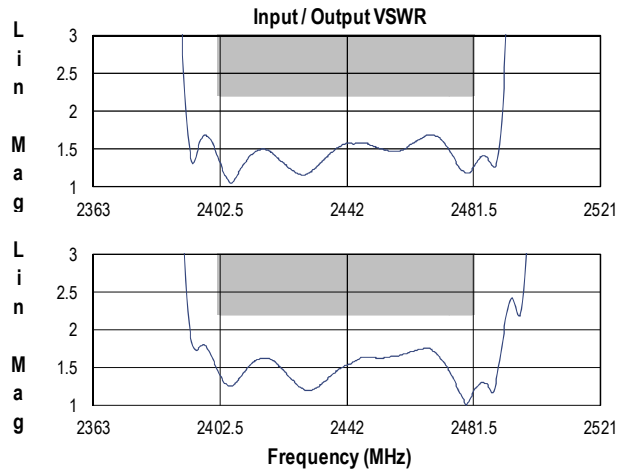
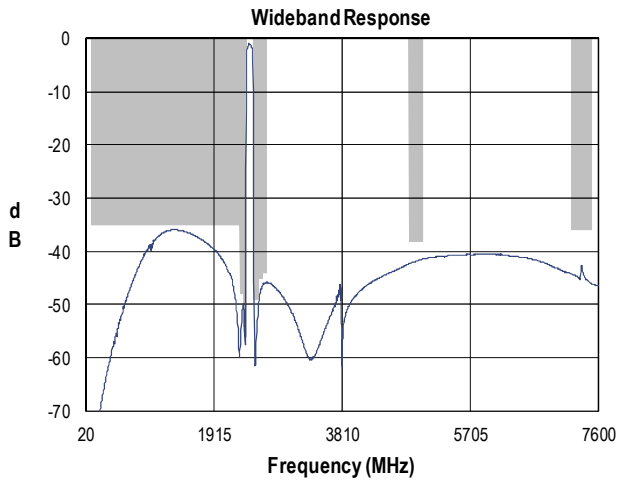
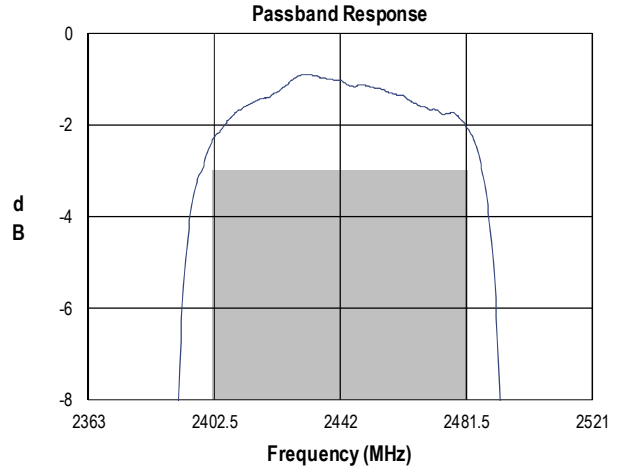
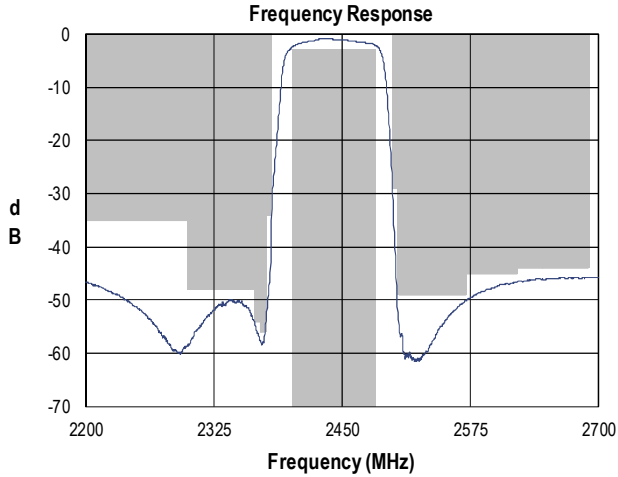

Input Smith Chart

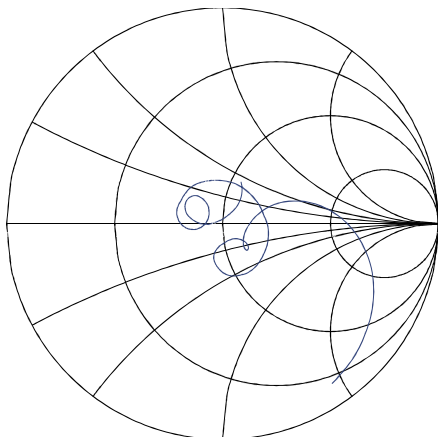

Output Smith Chart

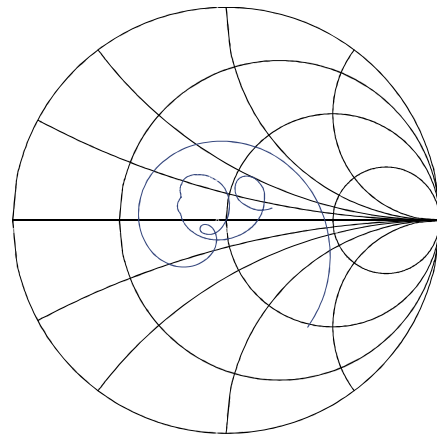

Package Information, Marking and Dimensions

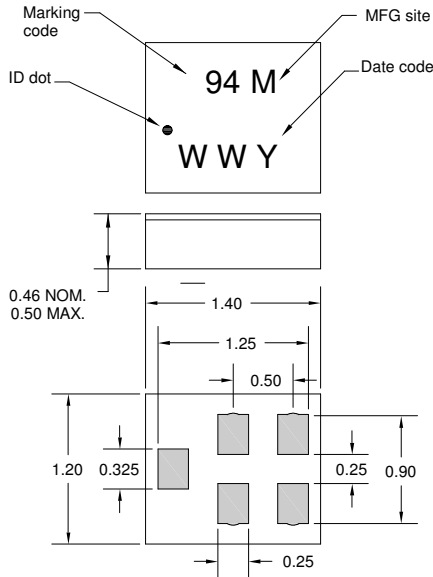

Package Style: CSP-5CT
 Dimensions: 1.4 x 1.2 x 0.46 mm

Body: Al_2O_3 ceramic
 Lid: Kovar or Alloy 42, Au over Ni plated
 Terminations: Au plating 0.5 - 1.0 μ m, over a 2-6 μ m Ni plating.

All tolerances are ± 0.15 mm except overall length and width ± 0.10 mm.

The date code consists of: WW = 2 digit week, Y = last digit of year, M = manufacturing site code.

Notes:

1. All dimensions shown are typical in millimeters.
2. An asterisk (*) in front of the marking code indicates prototype.

PCB Mounting Pattern

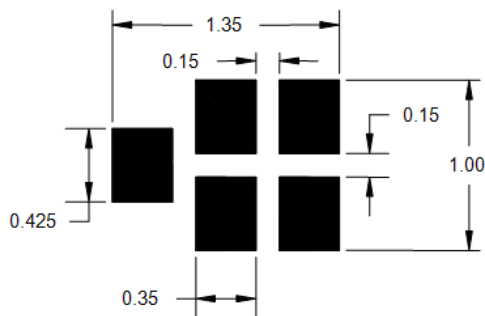

Notes:

1. All dimensions are in millimeters. Angles are in degrees.
2. This drawing specifies the mounting pattern used on the TriQuint evaluation board for this product. Some modification may be necessary to suit end user assembly materials and processes.

Tape and Reel information

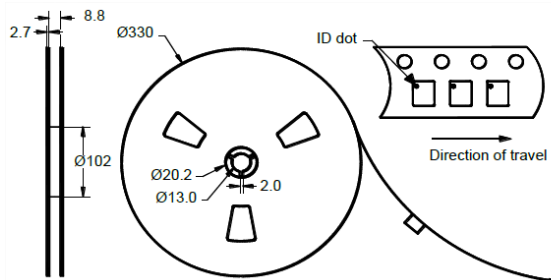

Standard T/R size=10,000 units/reel.
 All dimensions are in millimeters.

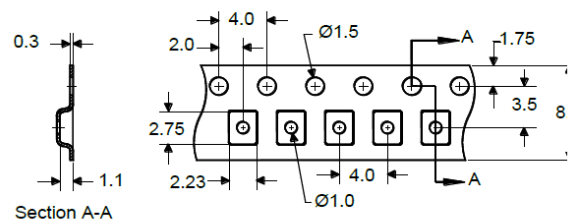

Product Compliance Information

ESD Sensitivity Ratings



Caution! ESD-Sensitive Device

ESD Rating: Class 1B
Value: 800 V
Test: Human Body Model (HBM)
Standard: ESDA/JEDEC JS-001-2012

ESD Rating: 350 V
Value: 350 V
Test: Machine Model (MM)
Standard: JEDEC Standard JESD22-A115

MSL Rating

Not applicable. Hermetic package.

Solderability

Compatible with the latest version of J-STD-020, lead free solder, 260 °C

Refer to [Soldering Profile](#) for recommended guidelines.

RoHs Compliance

This part is compliant with EU 2002/95/EC RoHS directive (Restrictions on the Use of Certain Hazardous Substances in Electrical and Electronic Equipment).

This product also has the following attributes:

- Halogen Free (Chlorine, Bromine)
- Antimony Free
- TBBP-A (C₁₅H₁₂Br₄O₂) Free
- PFOS Free
- SVHC Free

Contact Information

For the latest specifications, additional product information, worldwide sales and distribution locations, and information about TriQuint:

Web: www.triquint.com
Email: info-sales@tqs.com

Tel: +1.407.886.8860
Fax: +1.407.886.7061

For technical questions and application information: **Email:** flapplication.engineering@tqs.com

Important Notice

The information contained herein is believed to be reliable. TriQuint makes no warranties regarding the information contained herein. TriQuint assumes no responsibility or liability whatsoever for any of the information contained herein. TriQuint assumes no responsibility or liability whatsoever for the use of the information contained herein. The information contained herein is provided "AS IS, WHERE IS" and with all faults, and the entire risk associated with such information is entirely with the user. All information contained herein is subject to change without notice. Customers should obtain and verify the latest relevant information before placing orders for TriQuint products. The information contained herein or any use of such information does not grant, explicitly or implicitly, to any party any patent rights, licenses, or any other intellectual property rights, whether with regard to such information itself or anything described by such information.

TriQuint products are not warranted or authorized for use as critical components in medical, life-saving, or life-sustaining applications, or other applications where a failure would reasonably be expected to cause severe personal injury or death.