

RFFM6204

2.0V to 4.0V, 2.4GHz Front End Module

The RFFM6204 is a complete integrated solution in a single Front End Module (FEM) for ZigBee® applications in the 2.4GHz to 2.5GHz band. The ultra-small factor and integrated matching minimizes layout area in the customer's application and greatly reduces the number of external components. This simplifies the total front end solution by reducing the bill of materials, system footprint, and manufacturing cost.

The FEM integrates a power amplifier (PA) plus harmonic filter in the transmit (TX) path, a low noise amplifier (LNA) in the receive (RX) path, and a low loss bidirectional through mode path. The RFFM6204 incorporates two single-pole triple-throw (SP3T) switches to provide a single balanced TDD access and a single antenna port for TX, RX, and through mode paths. The device is provided in a 2.5mm x 2.5mm x 0.5mm, 16-pin QFN package.

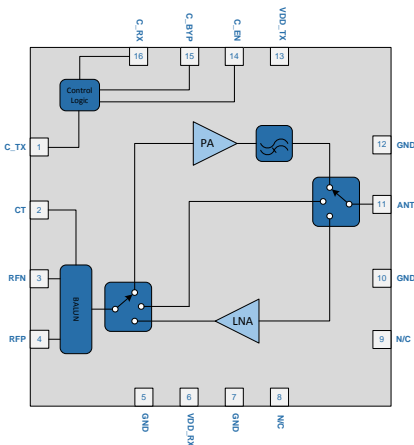

Functional Block Diagram

Ordering Information

RFFM6204SB	Standard 5 piece bag
RFFM6204SQ	Standard 25 piece bag
RFFM6204SR	Standard 100 piece reel
RFFM6204TR7	Standard 2500 piece reel
RFFM6204PCK-410	Fully assembled evaluation board w/5 pc bag



Package: QFN, 16-pin,
2.5mm x 2.5mm x 0.5mm

Features

- Tx Output Power = 13dBm
- Integrated RF Front End Module with Rx/Tx Balun, PA, Filter, LNA, Bidirectional Thru path and 2-SP3T Switches
- Single Bidirectional Differential Transceiver Interface.
- Voltage Range = 2.0V to 4.0V
- Rx Noise Figure = 2.5dB

Applications

- ZigBee® 802.15.4 Based Systems for Remote Monitoring and Control
- AA Battery Operation
- 2.4GHz ISM Band Applications
- Smart Meters for Energy Management

Absolute Maximum Ratings

Parameter	Rating	Unit
Voltage	4.5	V
Operating Temperature	-40 to +125	°C
Storage Temperature	-40 to +150	°C
Maximum Input Power to PA	+20	dBm
Maximum Input Power to LNA	+5	dBm
ESD, HBM	1000	V
ESD, CDM	1000	V
Moisture Sensitivity	MSL 2	



Caution! ESD sensitive device.



RFMD Green: RoHS status based on EU Directive 2011/65/EU (at time of this document revision), halogen free per IEC 61249-2-21, < 1000ppm each of antimony trioxide in polymeric materials and red phosphorus as a flame retardant, and <2% antimony in solder.

Exceeding any one or a combination of the Absolute Maximum Rating conditions may cause permanent damage to the device. Extended application of Absolute Maximum Rating conditions to the device may reduce device reliability. Specified typical performance or functional operation of the device under Absolute Maximum Rating conditions is not implied.

Nominal Operating Parameters

Parameter	Specification			Unit	Condition
	Min	Typ	Max		
					Specifications must be met across supply voltage, control voltage, and temperature ranges unless otherwise specified
TX Frequency	2405		2485	MHz	
RX Frequency	2405		2485	MHz	
Bypass Frequency	2405		2485	MHz	
ANT RF Port Impedance		50		Ω	
Balanced RF Port Impedance		100		Ω	
V _{BAT}	2.0	3.0	4.0	V	
Current Source through CT pin			24.0	mA	
CT pin resistance to RFP/RFN		30		Ω	
Off Mode Current - Leakage					V_{DD_TX} = 3.0V, C_EN = Low, V_{DD_RX} = 3.0V, C_TX = Low, C_RX = Low, C_BYP = Low, Temp = 25°C
Supply Current - IDDTX		50		nA	
Supply Current – IDDRX		50		nA	
C_RX Current			1.0	nA	
C_TX Current			1.0	nA	
C_BYP Current			1.0	nA	
Transmit Mode - Power Amplifier					V_{DD_TX} = 3.0V, C_EN = High, V_{DD_RX} = 3.0V, C_TX = High, C_RX = Low, C_BYP = Low, Temp = 25°C unless otherwise specified
Input Return Loss			10.0	dB	Pins 3, 4 (RFN, RFP) 100 Ω differential
Output Return Loss			8.0	dB	
Gain		13.0		dB	
Gain Flatness	-0.3		0.3	dB	

Parameter	Specification			Unit	Condition
	Min	Typ	Max		
Transmit Mode - Power Amplifier					$V_{DD_TX} = 3.0V$, $C_{EN} = \text{High}$, $V_{DD_RX} = 3.0V$, $C_{TX} = \text{High}$, $C_{RX} = \text{Low}$, $C_{BYP} = \text{Low}$, Temp = 25°C unless otherwise specified
Rated Output Power		15.0		dBm	$V_{DD_TX} = 4.0V$
	13.3			dBm	$V_{DD_TX} = 3.3V$
	13.0			dBm	$V_{DD_TX} = 3.0V$
	10.0			dBm	$V_{DD_TX} = 2.0V$
Supply Current		15	18	mA	$V_{DD_TX} = 2.0V$; $P_{OUT} = 10\text{dBm}$
		19	23	mA	$V_{DD_TX} = 3.0V$; $P_{OUT} = 13\text{dBm}$
		21	27	mA	$V_{DD_TX} = 4.0V$; $P_{OUT} = 15\text{dBm}$
Second Harmonic ($2f_0$)		-20.0	-15.0	dBm/MHz	$P_{OUT} = 13\text{dBm}$
		-45.0	-42.0	dBm/MHz	$P_{OUT} = 13\text{dBm}$, with external filter
Third Harmonic ($3f_0$)		-35.0	-30.0	dBm/MHz	$P_{OUT} = 13\text{dBm}$
		-45.0	-42.0	dBm/MHz	$P_{OUT} = 13\text{dBm}$, with external filter
VSWR			4:1		Stability (ruggedness)
			8:1		No Damage
Gain Settling Time		230	300	ns	
Receive Mode – LNA					$V_{DD_TX} = 3.0V$, $C_{EN} = \text{High}$, $V_{DD_RX} = 3.0V$, $C_{TX} = \text{Low}$, $C_{RX} = \text{High}$, $C_{BYP} = \text{Low}$, Temp = 25°C
Input Return Loss			10.0	dB	
Output Return Loss			10.0	dB	Pins 3, 4 (RFN, RFP) 100 Ω differential
Gain	10.5	12.0	13.5	dB	
Gain Flatness	-0.5		0.5	dB	
Noise Figure		2.5	3.0	dB	
Supply Current		4.0		mA	
IIP3		4.0		dBm	
IP1dB		-5.0		dBm	
Amplitude Imbalance	-0.5		0.5	dB	
Phase Imbalance	-5.0		5.0	°	
Bidirectional Thru Mode					$V_{DD_TX} = 3.0V$, $C_{EN} = \text{High}$, $V_{DD_RX} = 3.0V$, $C_{TX} = \text{Low}$, $C_{RX} = \text{Low}$, $C_{BYP} = \text{High}$, Temp = 25°C
Input Return Loss			12.0	dB	
Output Return Loss			10.0	dB	Pins 3, 4 (RFN, RFP) 100 Ω differential
Insertion Loss		3.0	3.5	dB	
Gain flatness	-0.1		0.1	dB	
Supply Current		100		nA	
IIP3	35.0			dBm	
Amplitude Imbalance	-0.1		0.1	dB	
Phase Imbalance	-5.0		5.0	°	
Maximum Input Power			25	dBm	

Parameter	Specification			Unit	Condition
	Min	Typ	Max		
Logic					
Logic Level "High"	1.6	1.8	V _{BAT}	V	
Logic Level "Low"	0.0		0.2	V	
C_TX Input source current at Logic "High"		100	800	uA	
C_RX Input source current at Logic "High"		100	800	uA	
C_BYP Input source current at Logic "High"			0.1	uA	
C_EN Input source current at Logic "High"			2	uA	
Input source current Logic Level "Low", All Logic pins			0.001	μA	

Switch Control Logic Table

Mode	C_EN	C_TX	C_RX	C_BYP
TX Mode	High	High	Low	Low
RX Mode	High	Low	High	Low
Bypass Mode	High	Low	Low	High
Power Down	Low	Low	Low	Low

Evaluation PCB Schematic

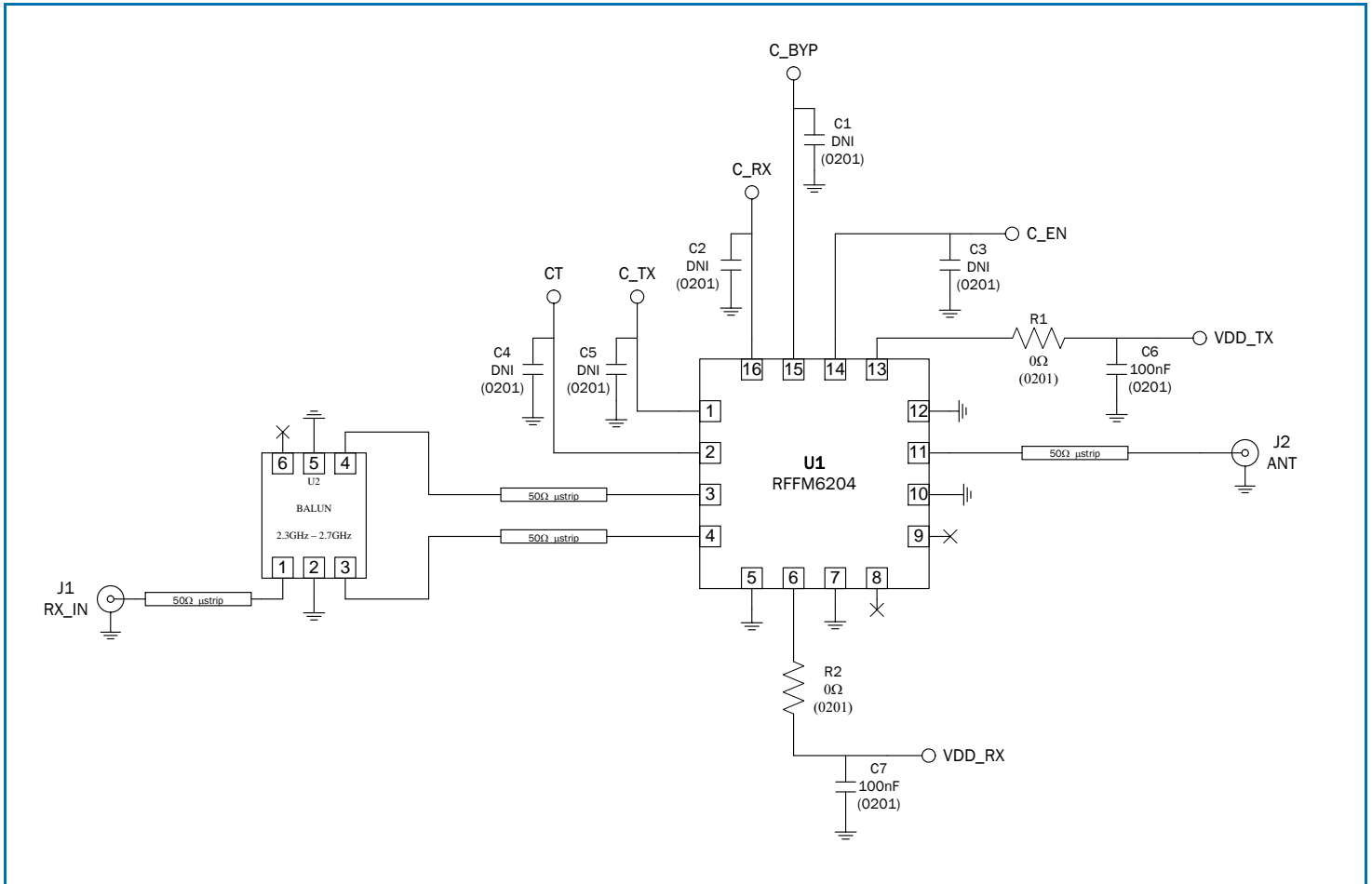

Application Schematic

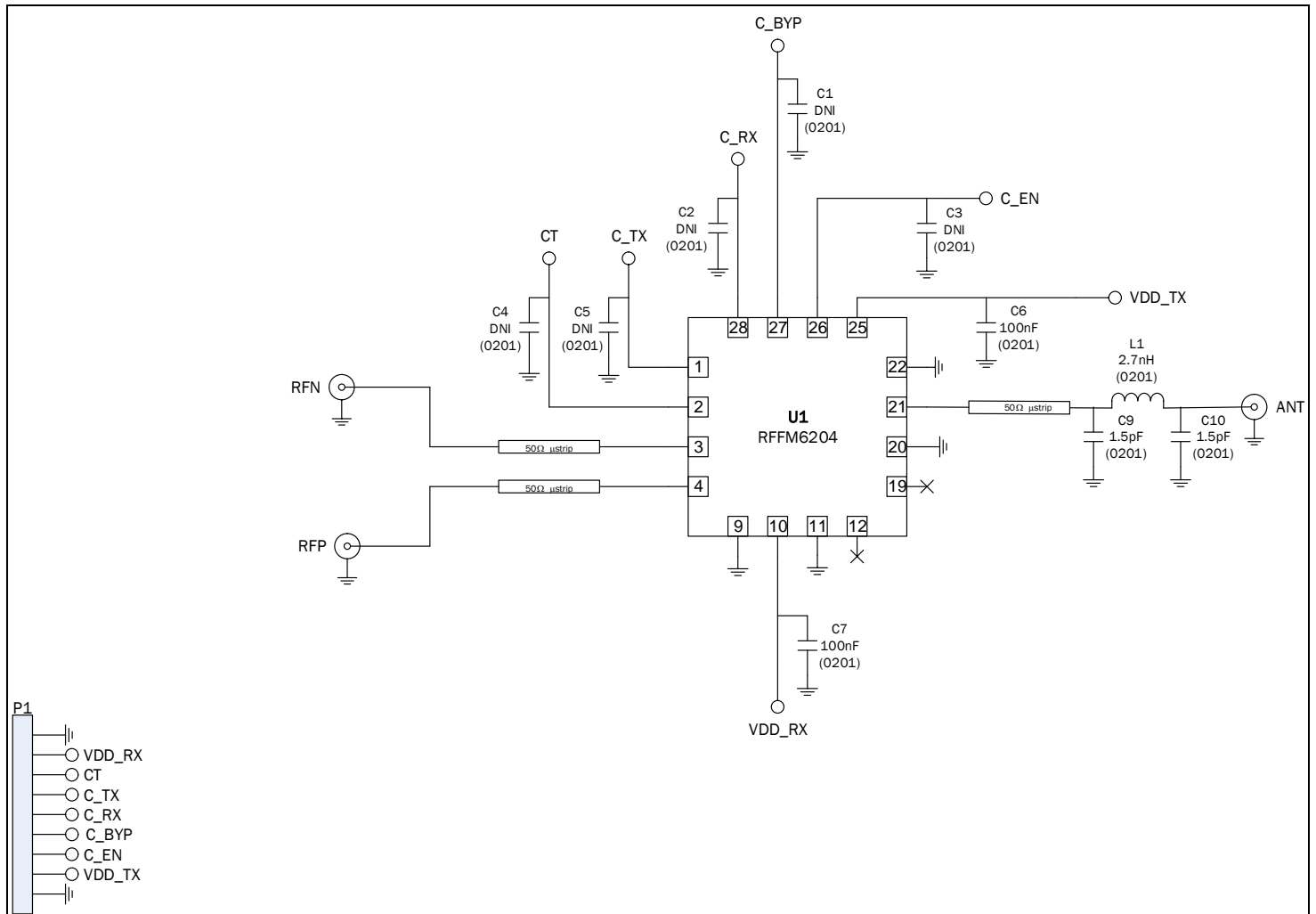

Pin Out

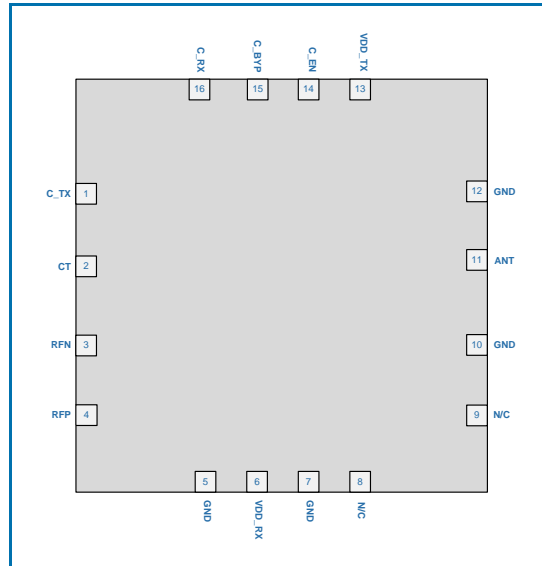

Package Outline and Branding Drawing (Dimensions in millimeters)

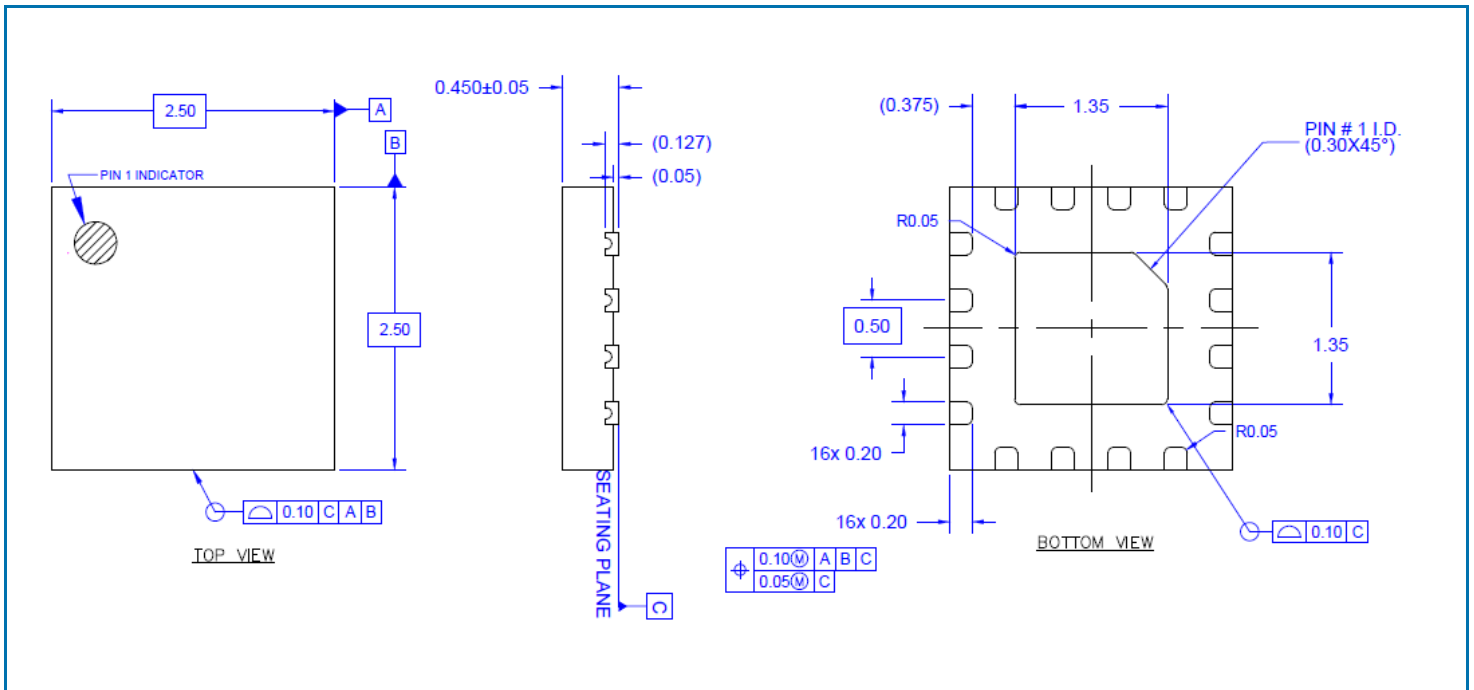

Recommended PCB Patterns

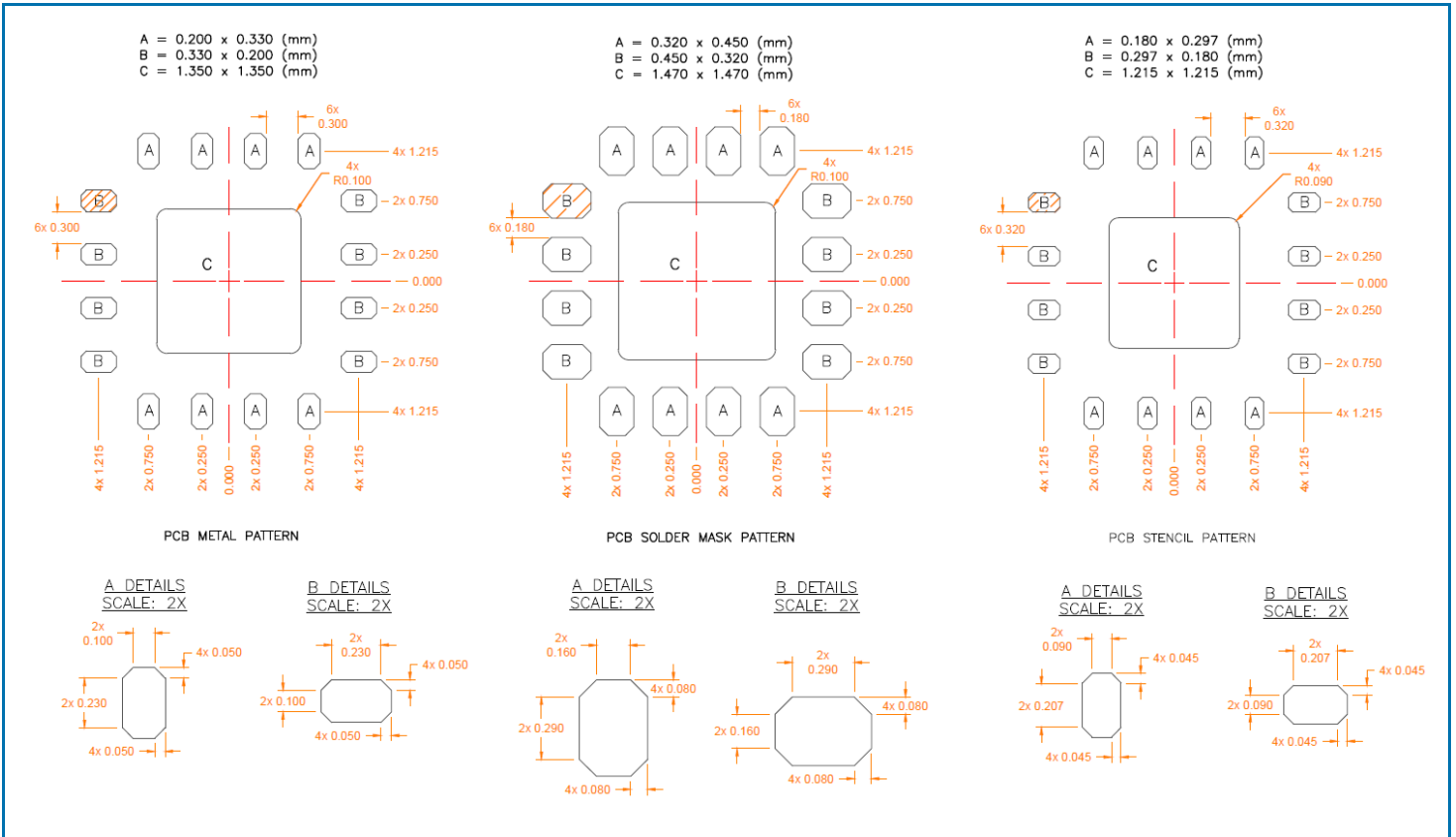

Pin Names and Descriptions

Pin	Name	Description
1	C_TX	Control Pin: Transmit Enable/Disable, view logic table for operation
2	CT	Balun Center Tap: DC bias voltage to RFN and RFP pins
3	RFN	Negative Differential RF Input/Output signal: 100ohm differential
4	RFP	Positive Differential RF Input/Output signal: 100ohm differential
5	GND	No Internal Connection; Ground on PCB
6	VDD_RX	Receive Low Noise Amplifier Voltage Supply
7	GND	No Internal Connection; Ground on PCB
8	N/C	No Internal Connection; No Connect on PCB
9	N/C	No Internal Connection; No Connect on PCB
10	GND	No Internal Connection; Ground on PCB
11	ANT	Antenna Switch Common Port, internally matched to 50 ohms, DC Blocked
12	GND	No Internal Connection; Ground on PCB
13	VDD_TX	Transmit Power Amplifier Voltage Supply
14	C_EN	Control Pin: Enable FEM, view logic table for operation
15	C_BYP	Control Pin: Bypass Enable/Disable, view logic table for operation
16	C_RX	Control Pin: Receive Enable/Disable, view logic table for operation