

N-Channel 30-V (D-S) MOSFET

PRODUCT SUMMARY			
V _{DS} (V)	R _{DS(on)} (Ω)	I _D (A) ^{a, e}	Q _g (Typ)
30	0.0038 at V _{GS} = 10 V	98	82 nC
	0.0044 at V _{GS} = 4.5 V	98	

FEATURES

- TrenchFET® Power MOSFET
- 100 % R_g and UIS Tested
- Compliant to RoHS Directive 2011/65/EU



APPLICATIONS

- OR-ing
- Server
- DC/DC

I²PAK
(TO-262)

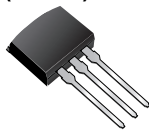

VBNC1303

D²PAK
(TO-263)



VBL1303

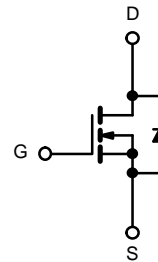

N-Channel MOSFET

ABSOLUTE MAXIMUM RATINGS (T _A = 25 °C, unless otherwise noted)				
Parameter	Symbol	Limit	Unit	
Drain-Source Voltage	V _{DS}	30	V	
Gate-Source Voltage	V _{GS}	± 20		
Continuous Drain Current (T _J = 175 °C)	I _D	T _C = 25 °C	98 ^{a, e}	A
		T _C = 70 °C	98 ^e	
		T _A = 25 °C	28.8 ^{b, c}	
		T _A = 70 °C	27 ^{b, c}	
Pulsed Drain Current	I _{DM}	300		
Avalanche Current Pulse	I _{AS}	36	L = 0.1 mH	V
Single Pulse Avalanche Energy				
Continuous Source-Drain Diode Current	I _S	T _C = 25 °C	90 ^{a, e}	A
		T _A = 25 °C	3.13 ^{b, c}	
Maximum Power Dissipation	P _D	T _C = 25 °C	250 ^a	W
		T _C = 70 °C	175	
		T _A = 25 °C	3.75 ^{b, c}	
		T _A = 70 °C	2.63 ^{b, c}	
Operating Junction and Storage Temperature Range	T _J , T _{stg}	- 55 to 175	°C	

THERMAL RESISTANCE RATINGS					
Parameter	Symbol	Typ.	Max.	Unit	
Maximum Junction-to-Ambient ^{b, d}	R _{thJA}	32	40	°C/W	
Maximum Junction-to-Case	R _{thJC}	0.5	0.6		

Notes:

a. Based on T_C = 25 °C.

b. Surface mounted on 1" x 1" FR4 board.

c. t = 10 sec.

d. Maximum under steady state conditions is 90 °C/W.

e. Calculated based on maximum junction temperature. Package limitation current is 90 A.

SPECIFICATIONS ($T_J = 25\text{ }^\circ\text{C}$, unless otherwise noted)						
Parameter	Symbol	Test Conditions	Min.	Typ.	Max.	Unit
Static						
Drain-Source Breakdown Voltage	V_{DS}	$V_{GS} = 0\text{ V}, I_D = 250\text{ }\mu\text{A}$	30			V
V_{DS} Temperature Coefficient	$\Delta V_{DS}/T_J$	$I_D = 250\text{ }\mu\text{A}$		35		mV/ $^\circ\text{C}$
$V_{GS(th)}$ Temperature Coefficient	$\Delta V_{GS(th)}/T_J$			-7.5		
Gate-Source Threshold Voltage	$V_{GS(th)}$	$V_{DS} = V_{GS}, I_D = 250\text{ }\mu\text{A}$	1.5		2.5	V
Gate-Source Leakage	I_{GSS}	$V_{DS} = 0\text{ V}, V_{GS} = \pm 20\text{ V}$			± 100	nA
Zero Gate Voltage Drain Current	I_{DSS}	$V_{DS} = 30\text{ V}, V_{GS} = 0\text{ V}$			1	μA
		$V_{DS} = 30\text{ V}, V_{GS} = 0\text{ V}, T_J = 55\text{ }^\circ\text{C}$			10	
On-State Drain Current ^a	$I_{D(on)}$	$V_{DS} \geq 5\text{ V}, V_{GS} = 10\text{ V}$	90			A
Drain-Source On-State Resistance ^a	$R_{DS(on)}$	$V_{GS} = 10\text{ V}, I_D = 28.8\text{ A}$		0.0024	0.0038	Ω
		$V_{GS} = 4.5\text{ V}, I_D = 27\text{ A}$		0.0027	0.0044	
Forward Transconductance ^a	g_{fs}	$V_{DS} = 15\text{ V}, I_D = 28.8\text{ A}$		160		S
Dynamic^b						
Input Capacitance	C_{iss}	$V_{DS} = 15\text{ V}, V_{GS} = 0\text{ V}, f = 1\text{ MHz}$		12065		pF
Output Capacitance	C_{oss}			1725		
Reverse Transfer Capacitance	C_{rss}			970		
Total Gate Charge	Q_g	$V_{DS} = 15\text{ V}, V_{GS} = 10\text{ V}, I_D = 28.8\text{ A}$		171	257	nC
		$V_{DS} = 15\text{ V}, V_{GS} = 4.5\text{ V}, I_D = 28.8\text{ A}$		81.5	123	
Gate-Source Charge	Q_{gs}			34		
Gate-Drain Charge	Q_{gd}		29			
Gate Resistance	R_g	$f = 1\text{ MHz}$		1.4	2.1	Ω
Turn-On Delay Time	$t_{d(on)}$	$V_{DD} = 15\text{ V}, R_L = 0.625\text{ }\Omega$ $I_D \cong 24\text{ A}, V_{GEN} = 10\text{ V}, R_g = 1\text{ }\Omega$		18	27	ns
Rise Time	t_r			11	17	
Turn-Off Delay Time	$t_{d(off)}$			70	105	
Fall Time	t_f			10	15	
Turn-On Delay Time	$t_{d(on)}$	$V_{DD} = 15\text{ V}, R_L = 0.67\text{ }\Omega$ $I_D \cong 22.5\text{ A}, V_{GEN} = 4.5\text{ V}, R_g = 1\text{ }\Omega$		55	83	
Rise Time	t_r			180	270	
Turn-Off Delay Time	$t_{d(off)}$			55	83	
Fall Time	t_f			12	18	
Drain-Source Body Diode Characteristics						
Continuous Source-Drain Diode Current	I_S	$T_C = 25\text{ }^\circ\text{C}$			90	A
Pulse Diode Forward Current ^a	I_{SM}				90	
Body Diode Voltage	V_{SD}	$I_S = 22\text{ A}$		0.8	1.2	V
Body Diode Reverse Recovery Time	t_{rr}	$I_F = 20\text{ A}, di/dt = 100\text{ A}/\mu\text{s}, T_J = 25\text{ }^\circ\text{C}$		52	78	ns
Body Diode Reverse Recovery Charge	Q_{rr}			70.2	105	nC
Reverse Recovery Fall Time	t_a			27		ns
Reverse Recovery Rise Time	t_b			25		

Notes:

- a. Pulse test; pulse width $\leq 300\text{ }\mu\text{s}$, duty cycle $\leq 2\%$.
- b. Guaranteed by design, not subject to production testing.

Stresses beyond those listed under "Absolute Maximum Ratings" may cause permanent damage to the device. These are stress ratings only, and functional operation of the device at these or any other conditions beyond those indicated in the operational sections of the specifications is not implied. Exposure to absolute maximum rating conditions for extended periods may affect device reliability.

TYPICAL CHARACTERISTICS (25 °C, unless otherwise noted)

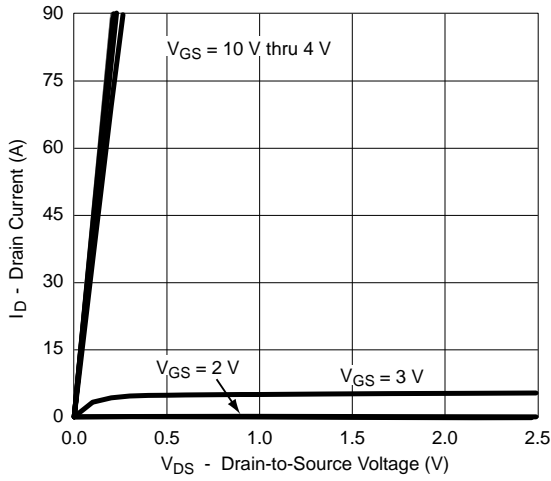

Output Characteristics



Transfer Characteristics



Transconductance

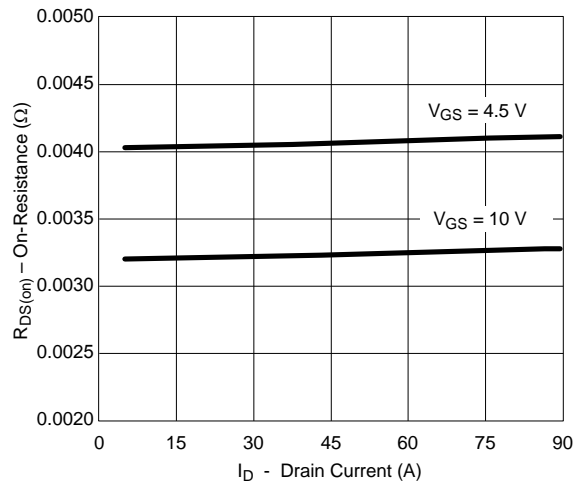

$R_{DS(on)}$ vs. Drain Current

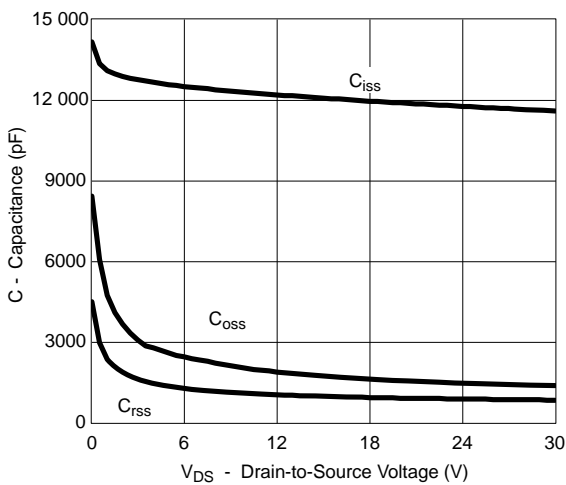

Capacitance

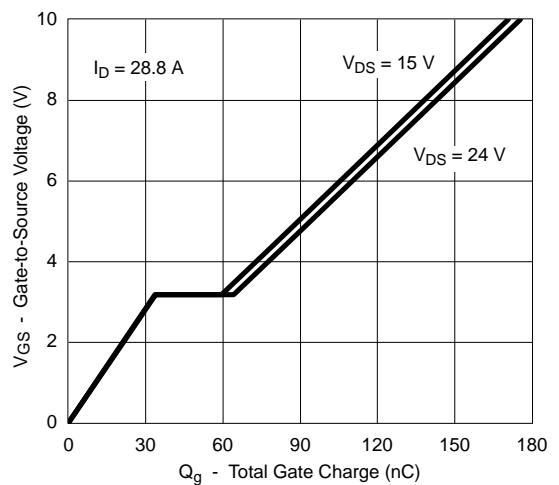

Gate Charge

TYPICAL CHARACTERISTICS (25 °C, unless otherwise noted)



On-Resistance vs. Junction Temperature



Forward Diode Voltage vs. Temperature

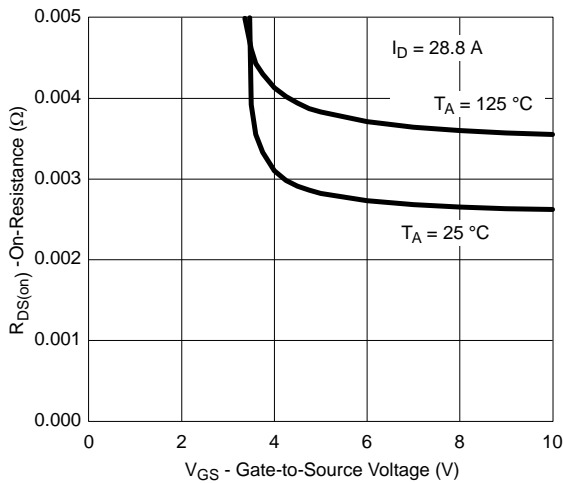

R_{DS(on)} vs. V_{GS} vs. Temperature



Threshold Voltage

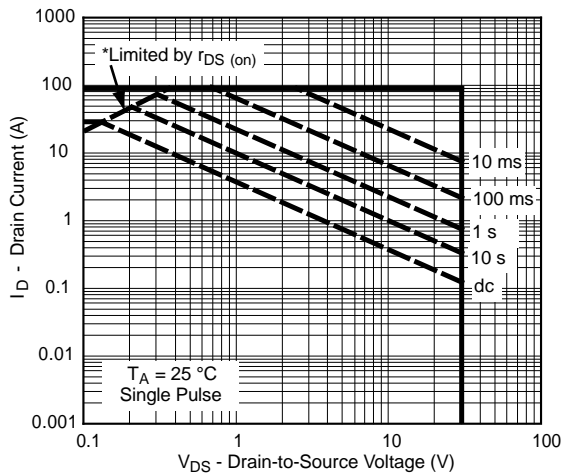

Safe Operating Area, Junction-to-Ambient
*V_{GS} > minimum V_{GS} at which r_{DS(on)} is specified

TYPICAL CHARACTERISTICS (25 °C, unless otherwise noted)

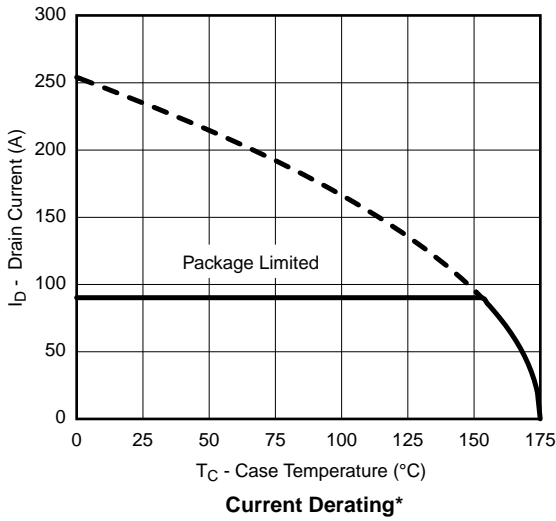

*The power dissipation P_D is based on T_{J(max)} = 175 °C, using junction-to-case thermal resistance, and is more useful in settling the upper dissipation limit for cases where additional heatsinking is used. It is used to determine the current rating, when this rating falls below the package limit.



TO-263AB (HIGH VOLTAGE)

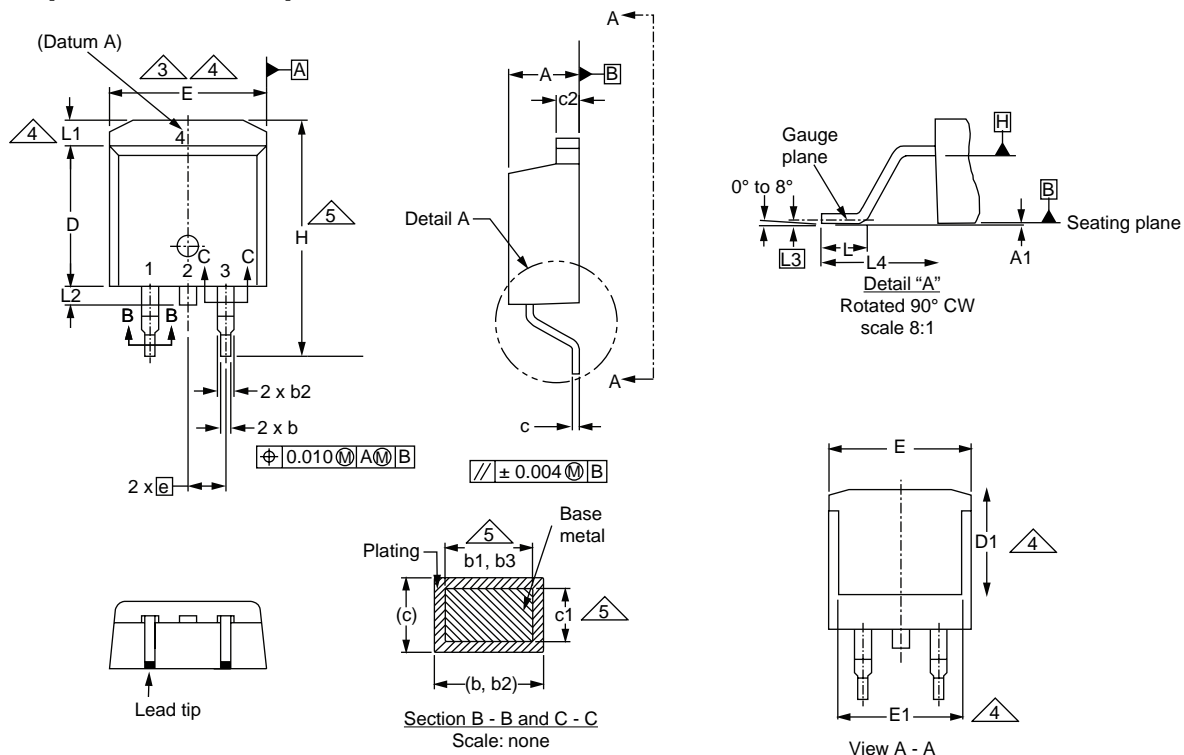

DIM.	MILLIMETERS		INCHES	
	MIN.	MAX.	MIN.	MAX.
A	4.06	4.83	0.160	0.190
A1	0.00	0.25	0.000	0.010
b	0.51	0.99	0.020	0.039
b1	0.51	0.89	0.020	0.035
b2	1.14	1.78	0.045	0.070
b3	1.14	1.73	0.045	0.068
c	0.38	0.74	0.015	0.029
c1	0.38	0.58	0.015	0.023
c2	1.14	1.65	0.045	0.065
D	8.38	9.65	0.330	0.380

DIM.	MILLIMETERS		INCHES	
	MIN.	MAX.	MIN.	MAX.
D1	6.86	-	0.270	-
E	9.65	10.67	0.380	0.420
E1	6.22	-	0.245	-
e	2.54 BSC		0.100 BSC	
H	14.61	15.88	0.575	0.625
L	1.78	2.79	0.070	0.110
L1	-	1.65	-	0.066
L2	-	1.78	-	0.070
L3	0.25 BSC		0.010 BSC	
L4	4.78	5.28	0.188	0.208

ECN: S-82110-Rev. A, 15-Sep-08
DWG: 5970

Notes

1. Dimensioning and tolerancing per ASME Y14.5M-1994.
2. Dimensions are shown in millimeters (inches).
3. Dimension D and E do not include mold flash. Mold flash shall not exceed 0.127 mm (0.005") per side. These dimensions are measured at the outmost extremes of the plastic body at datum A.
4. Thermal PAD contour optional within dimension E, L1, D1 and E1.
5. Dimension b1 and c1 apply to base metal only.
6. Datum A and B to be determined at datum plane H.
7. Outline conforms to JEDEC outline to TO-263AB.

RECOMMENDED MINIMUM PADS FOR D²PAK: 3-Lead

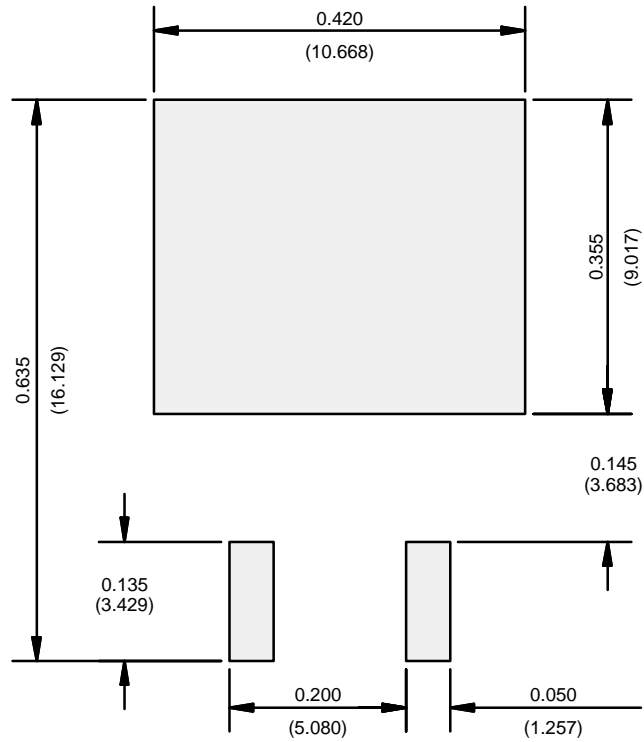

Recommended Minimum Pads
Dimensions in Inches/(mm)

Disclaimer

All products due to improve reliability, function or design or for other reasons, product specifications and data are subject to change without notice.

Taiwan VBsemi Electronics Co., Ltd., branches, agents, employees, and all persons acting on its or their representatives (collectively, the "Taiwan VBsemi"), assumes no responsibility for any errors, inaccuracies or incomplete data contained in the table or any other any disclosure of any information related to the product.(www.VBsemi.com)

Taiwan VBsemi makes no guarantee, representation or warranty on the product for any particular purpose of any goods or continuous production. To the maximum extent permitted by applicable law on Taiwan VBsemi relinquished: (1) any application and all liability arising out of or use of any products; (2) any and all liability, including but not limited to special, consequential damages or incidental ; (3) any and all implied warranties, including a particular purpose, non-infringement and merchantability guarantee.

Statement on certain types of applications are based on knowledge of the product is often used in a typical application of the general product VBsemi Taiwan demand that the Taiwan VBsemi of. Statement on whether the product is suitable for a particular application is non-binding. It is the customer's responsibility to verify specific product features in the products described in the specification is appropriate for use in a particular application. Parameter data sheets and technical specifications can be provided may vary depending on the application and performance over time. All operating parameters, including typical parameters must be made by customer's technical experts validated for each customer application. Product specifications do not expand or modify Taiwan VBsemi purchasing terms and conditions, including but not limited to warranty herein.

Unless expressly stated in writing, Taiwan VBsemi products are not intended for use in medical, life saving, or life sustaining applications or any other application. Wherein VBsemi product failure could lead to personal injury or death, use or sale of products used in Taiwan VBsemi such applications using client did not express their own risk. Contact your authorized Taiwan VBsemi people who are related to product design applications and other terms and conditions in writing.

The information provided in this document and the company's products without a license, express or implied, by estoppel or otherwise, to any intellectual property rights granted to the VBsemi act or document. Product names and trademarks referred to herein are trademarks of their respective representatives will be all.

Material Category Policy

Taiwan VBsemi Electronics Co., Ltd., hereby certify that all of the products are determined to be RoHS compliant and meets the definition of restrictions under Directive of the European Parliament 2011/65 / EU, 2011 Nian. 6. 8 Ri Yue restrict the use of certain hazardous substances in electrical and electronic equipment (EEE) - modification, unless otherwise specified as inconsistent.(www.VBsemi.com)

Please note that some documents may still refer to Taiwan VBsemi RoHS Directive 2002/95 / EC. We confirm that all products identified as consistent with the Directive 2002/95 / EC European Directive 2011/65 /.

Taiwan VBsemi Electronics Co., Ltd. hereby certify that all of its products comply identified as halogen-free halogen-free standards required by the JEDEC JS709A. Please note that some Taiwanese VBsemi documents still refer to the definition of IEC 61249-2-21, and we are sure that all products conform to confirm compliance with IEC 61249-2-21 standard level JS709A.