



TAI-SAW TECHNOLOGY CO., LTD.

No. 3, Industrial 2nd Rd., Ping-Chen Industrial District,
Taoyuan, 324, Taiwan, R.O.C.

TEL: 886-3-4690038 FAX: 886-3-4697532

E-mail: tstsales@mail.taisaw.com Web: www.taisaw.com

Product Specifications Approval Sheet

Product Name: SAW Rx Filter 1842.5 MHz LTE Band 3 SMD 1.1x0.9mm (BW=75 MHz)

TST Parts No.: TA1843D

Customer Parts No.: _____

Customer signature required
Company: _____
Division: _____
Approved by : _____
Date: _____

Checked by: _____ David Chang *David*

Approval by: _____ Andy Yu *Andy Yu*

Date: _____ 2019/01/16

1. Customer signed back is required before TST can proceed with sample build and receive orders.
2. Orders received without customer signed back will be regarded as agreement on the specifications.
3. Any specifications changes must be approved upon by both parties and a new revision of specifications shall be released to reflect the changes.



TAI-SAW TECHNOLOGY CO., LTD.

No. 3, Industrial 2nd Rd., Ping-Chen Industrial District,
Taoyuan, 324, Taiwan, R.O.C.

TEL: 886-3-4690038 FAX: 886-3-4697532

E-mail: tstsales@mail.taisaw.com Web: www.taisaw.com

SAW Filter 1842.5 MHz

MODEL NO.:TA1843D

REV.3.0

A. MAXIMUM RATING:

1. Maximum Input Power: 10 dBm
2. DC Voltage: 0 V
3. Operating Temperature: -20 °C to +85 °C
4. Storage Temperature Range: -40 °C to +85 °C
5. Moisture Sensitive Level: Level 3 (MSL 3)
6. ESD: 50 V(MM), 100 V(HBM)

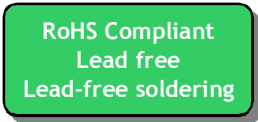

Electrostatic Sensitive Device (ESD)

B. ELECTRICAL CHARACTERISTICS:

Terminating source impedance: $Z_s = 50//33nH \Omega$ (Single-ended)

Terminating load impedance: $Z_L = 50//12nH \Omega$ (Single-ended)

Item		Unit	Min.	Typ.	Max.
Center Frequency		MHz	-	1842.5	-
Insertion Loss (*1)	1805 ~ 1880 MHz	dB	-	2.0	4.0
Amplitude Ripple	1805 ~ 1880 MHz	dB _{p-p}	-	1.0	3.3
VSWR	Input	1805 ~ 1880 MHz	-	1.7	2.3
	Output	1805 ~ 1880 MHz	-	1.6	2.2
Attenuation (Reference level from 0 dB)					
DC ~ 960 MHz		dB	32	35	-
1558 ~ 1608 MHz		dB	32	36	-
1710 ~ 1785 MHz		dB	34	38	-
1920 ~ 2400 MHz		dB	25	37	-
2400 ~ 2500 MHz		dB	33	39	-
2500 ~ 3610 MHz		dB	25	35	-
3610 ~ 3760 MHz		dB	25	38	-
3760 ~ 5415 MHz		dB	20	35	-
5415 ~ 5640 MHz		dB	20	36	-
5640 ~ 7220 MHz		dB	18	27	-
7220 ~ 7520 MHz		dB	16	25	-
7520 ~ 8000 MHz		dB	14	23	-

(*1) Specification of insertion loss excludes loss that comes from the test board.

C. EFREQUENCY CHARACTERISTICS:

Frequency Response

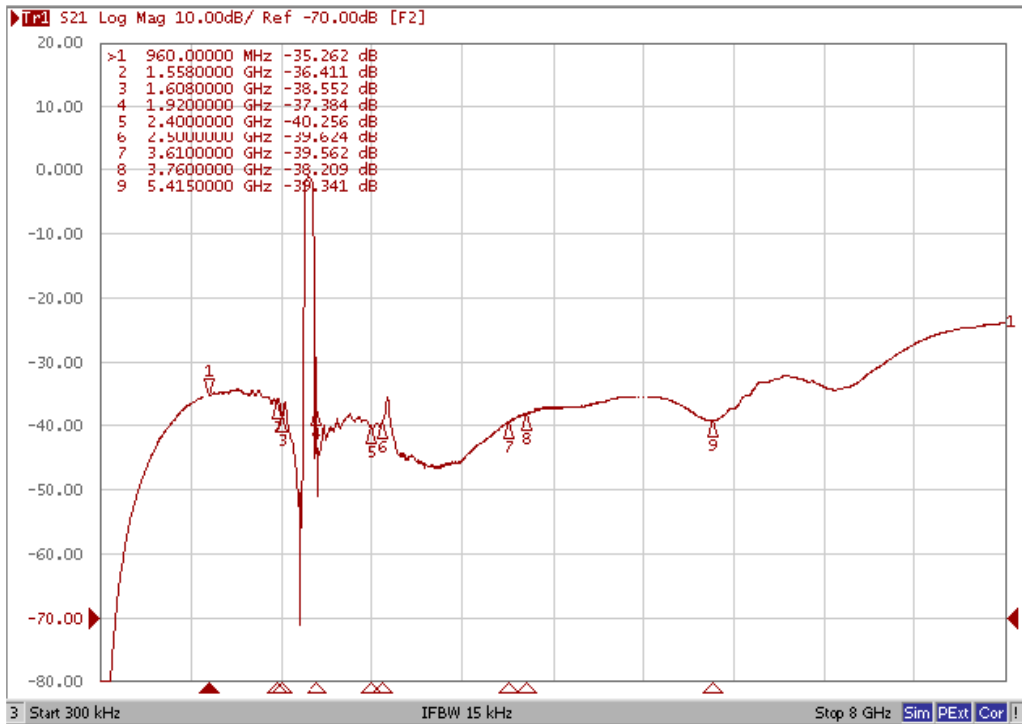
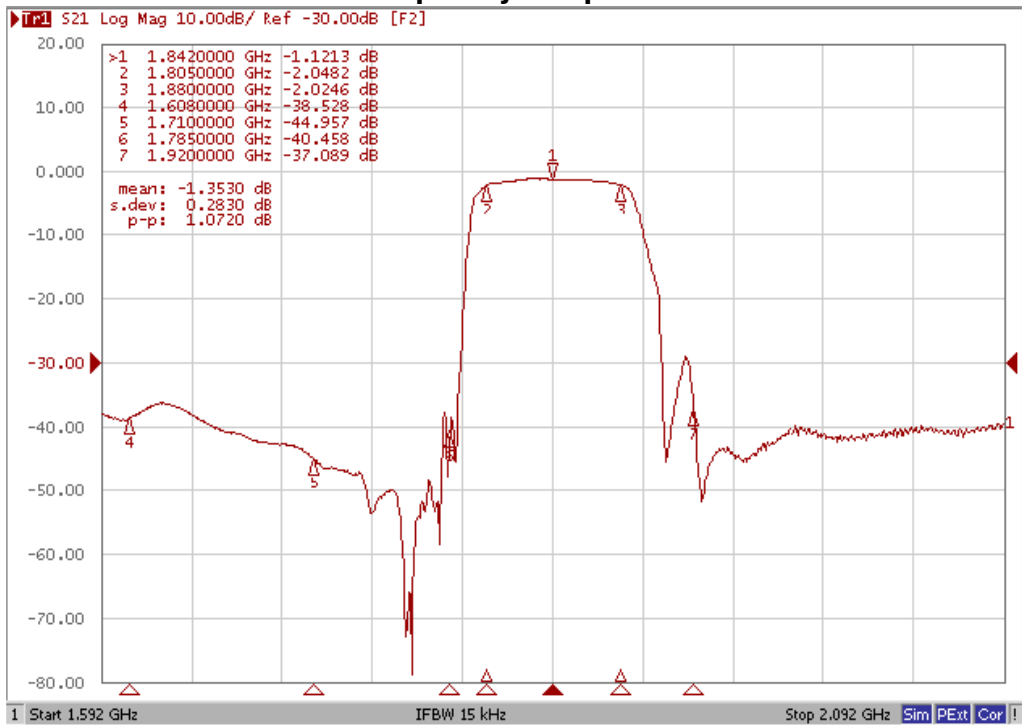

VSWR

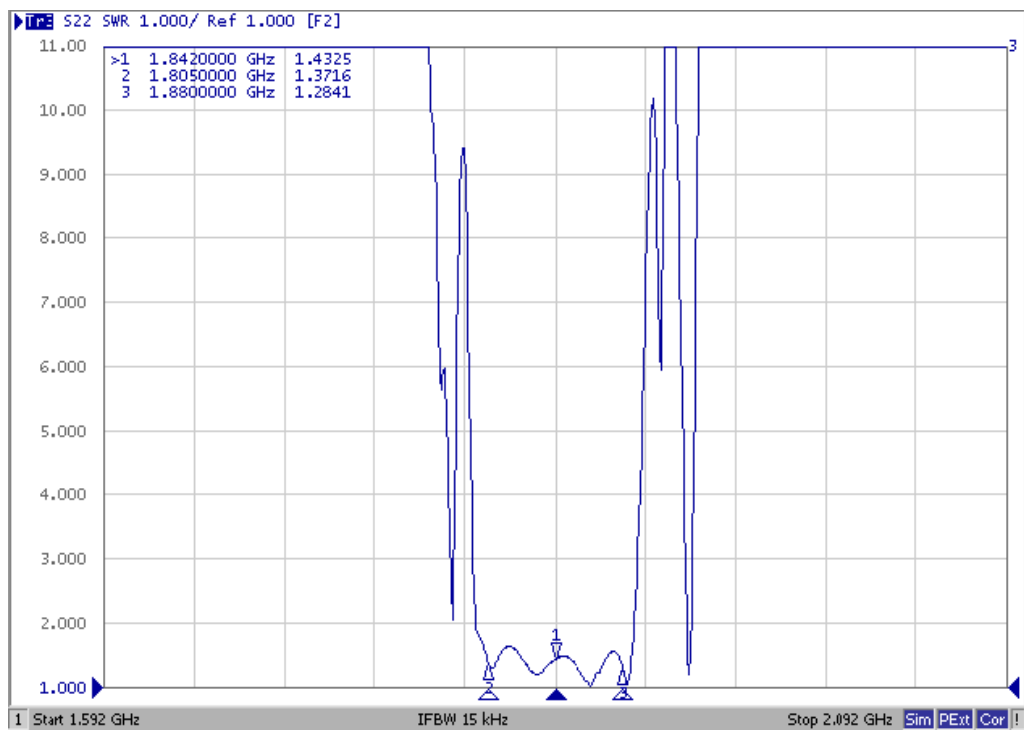
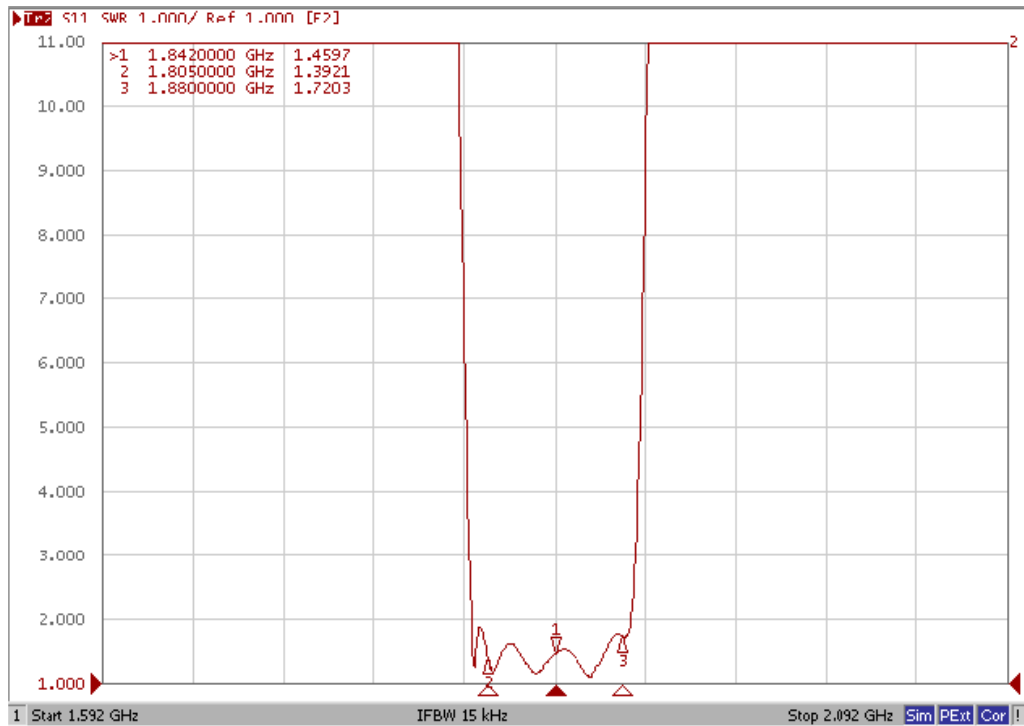

Smith Chart

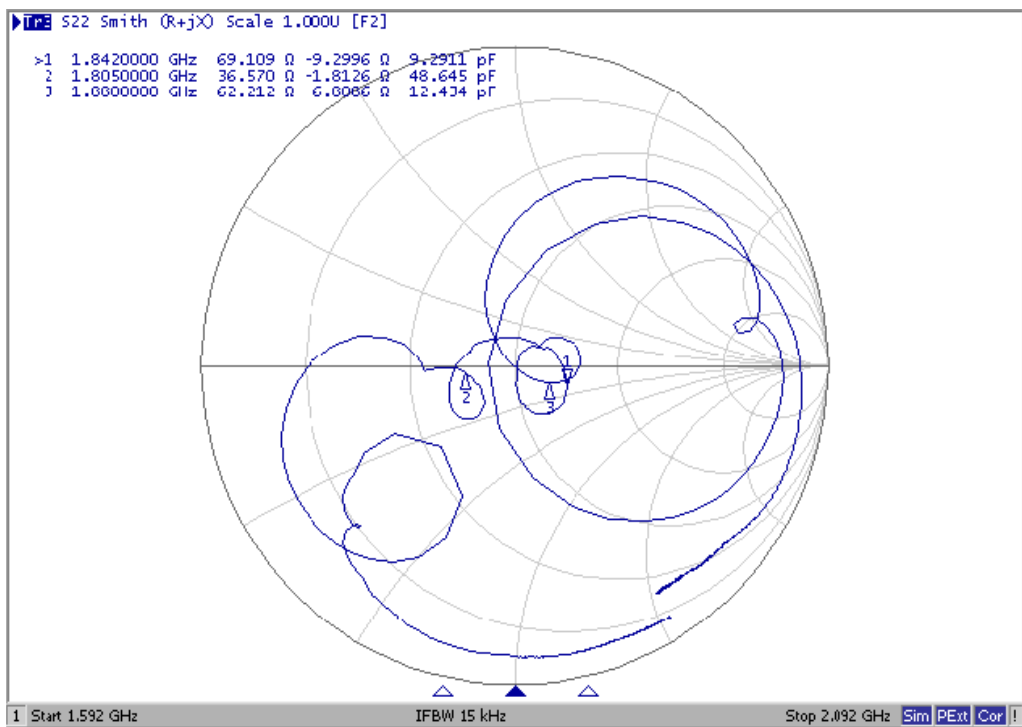
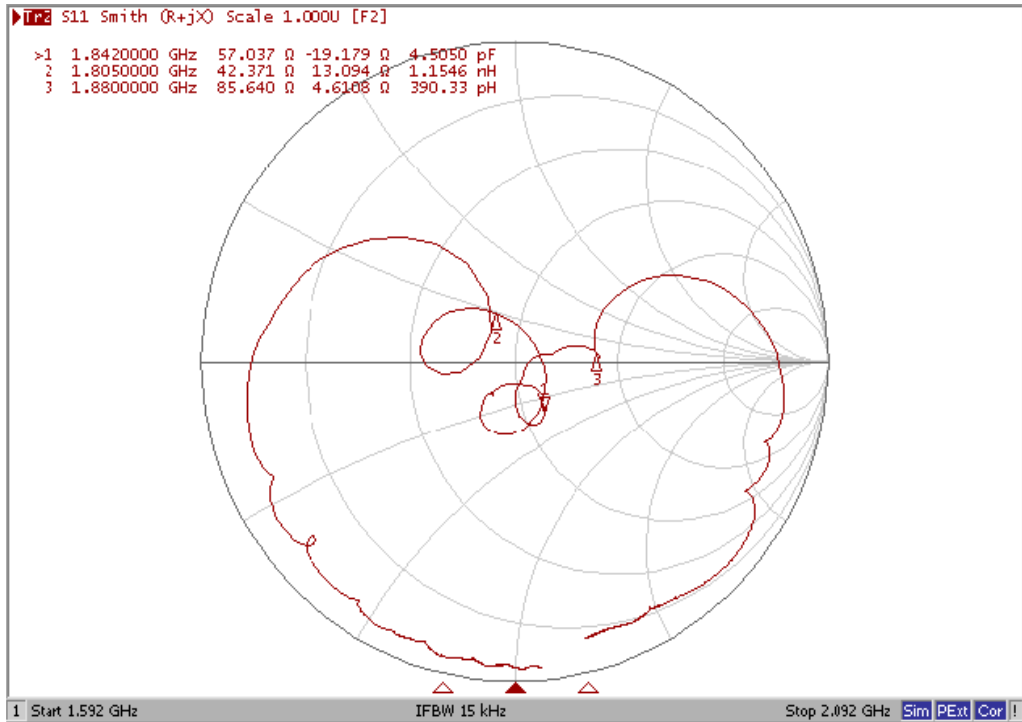

D. OUTLINE DRAWING:

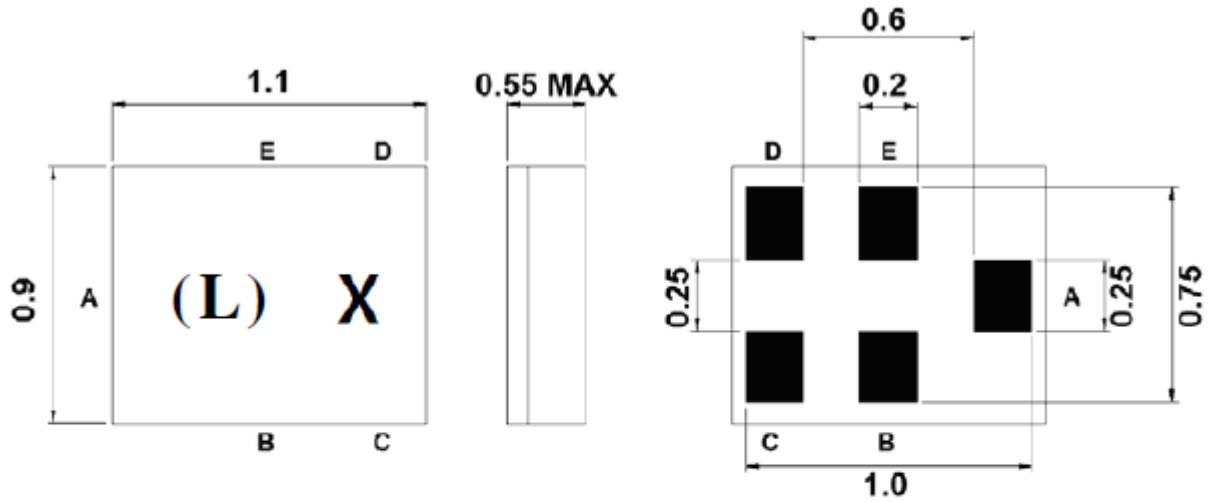

Pin Description	
B, C, E	Ground
A	Input
D	Output

Marking Descriptions:

(L): Series Number

X : Year/Month Code (Follow the table)

Date Code (Year/Month Code)

YEAR/Month	1	2	3	4	5	6	7	8	9	10	11	12
2013	A	B	C	D	E	F	G	H	J	K	L	M
2014	N	P	Q	R	S	T	U	V	W	X	Y	Z
2015	a	b	c	d	e	f	g	h	j	k	l	m
2016	n	p	q	r	s	t	u	v	w	x	y	z
2017	<u>A</u>	<u>B</u>	<u>C</u>	<u>D</u>	<u>E</u>	<u>F</u>	<u>G</u>	<u>H</u>	<u>J</u>	<u>K</u>	<u>L</u>	<u>M</u>
2018	<u>N</u>	<u>P</u>	<u>Q</u>	<u>R</u>	<u>S</u>	<u>T</u>	<u>U</u>	<u>V</u>	<u>W</u>	<u>X</u>	<u>Y</u>	<u>Z</u>
2019	<u>a</u>	<u>b</u>	<u>c</u>	<u>d</u>	<u>e</u>	<u>f</u>	<u>g</u>	<u>h</u>	<u>j</u>	<u>k</u>	<u>l</u>	<u>m</u>
2020	<u>n</u>	<u>p</u>	<u>q</u>	<u>r</u>	<u>s</u>	<u>t</u>	<u>u</u>	<u>v</u>	<u>w</u>	<u>x</u>	<u>y</u>	<u>z</u>

E. MEASUREMENT CIRCUIT:

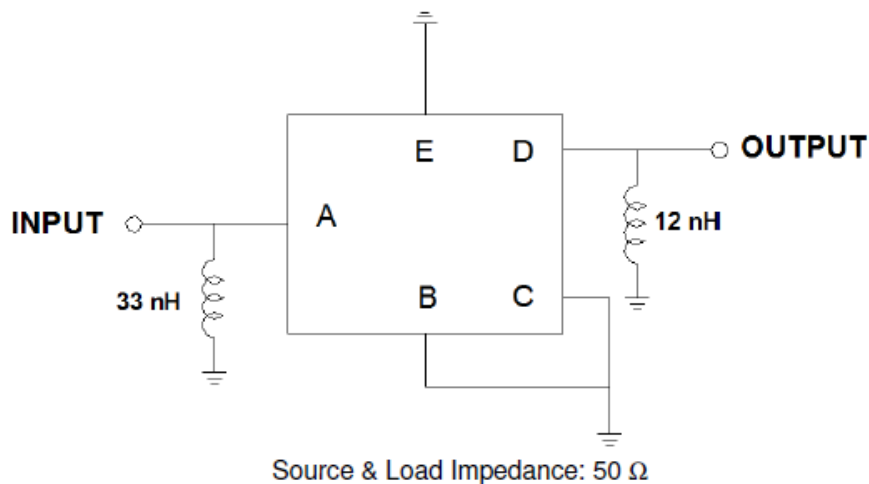

F. PCB Footprint:

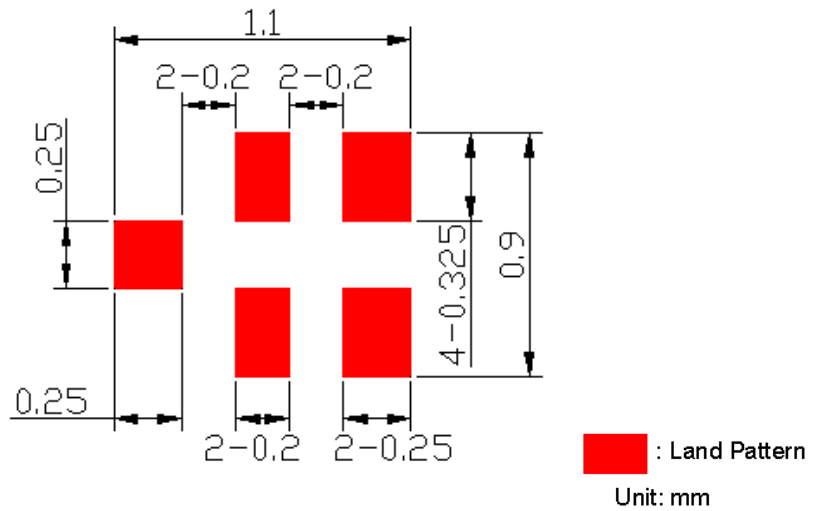

G. PACKING: (Ref: WI-75M03)

1. REEL DIMENSION

(Please refer to FR-75D10 for packing quantity)

