

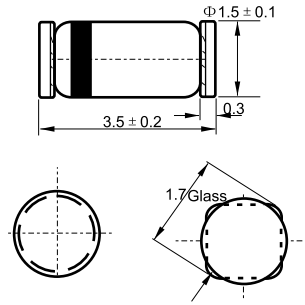

MINI-MELF

Features

- ✧ Zener voltage range 2.0 to 75 volts
- ✧ LL-34(Mini-MELF) package
- ✧ Surface device type mounting
- ✧ Hermetically sealed glass
- ✧ Compression Bonded Construction
- ✧ All external surfaces are corrosion resistant and terminals are readily solderable
- ✧ RoHS compliant
- ✧ Matte Tin(Sn) lead finish
- ✧ Blue color band indicates negative polarity



Dimension in millimeters

Maximum Ratings and Electrical Characteristics

Rating at 25 °C ambient temperature unless otherwise specified.

Type Number	Symbol	Value	Units
Power Dissipation	P _{tot}	500	mW
Operating and Storage Temperature Range	T _J , T _{STG}	-65 to + 200	°C

Notes: These ratings are limiting values above which the serviceability of the diode may be impaired

RATINGS AND CHARACTERISTIC CURVES (BZV55B SERIES)

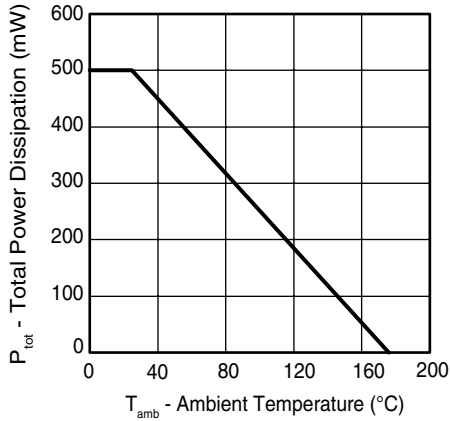

Figure 1. Total Power Dissipation vs. Ambient Temperature

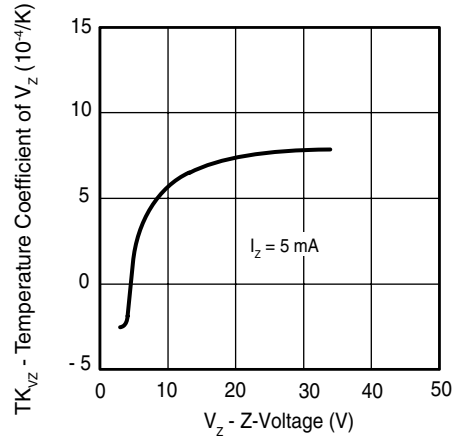

Figure 4. Temperature Coefficient of Vz vs. Z-Voltage

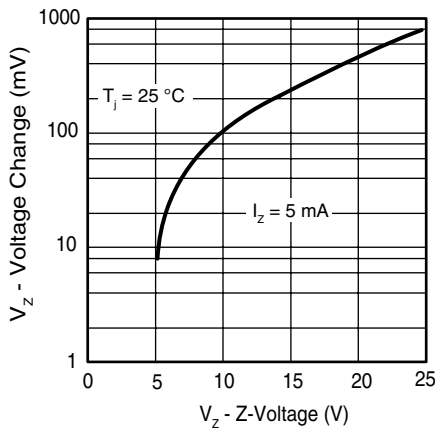

Figure 2. Typical Change of Working Voltage under Operating Conditions at $T_{amb}=25^{\circ}C$

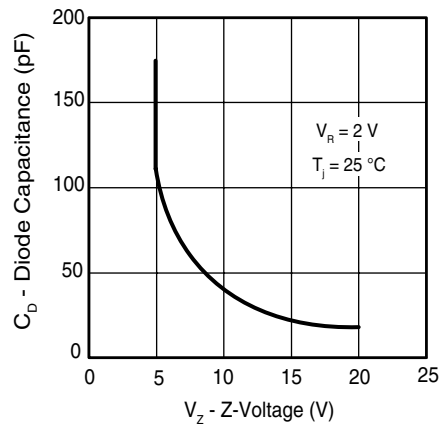

Figure 5. Diode Capacitance vs. Z-Voltage

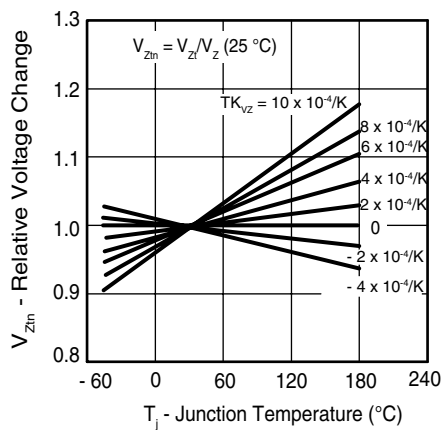

Figure 3. Typical Change of Working Voltage vs. Junction Temperature

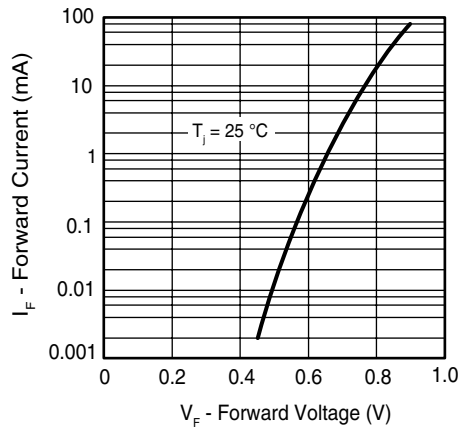

Figure 6. Forward Current vs. Forward Voltage

RATINGS AND CHARACTERISTIC CURVES (BZV55B SERIES)

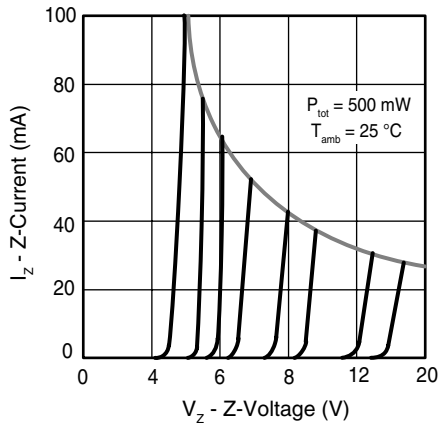

Figure 7. Z-Current vs. Z-Voltage

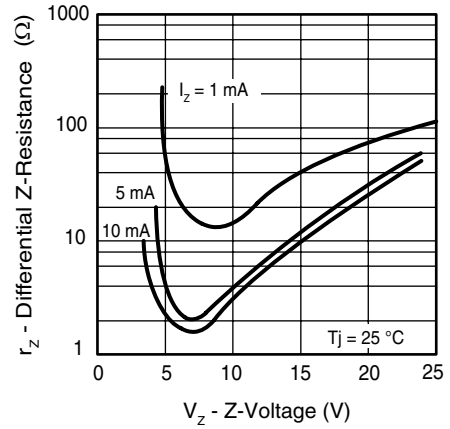

Figure 9. Differential Z-Resistance vs. Z-Voltage

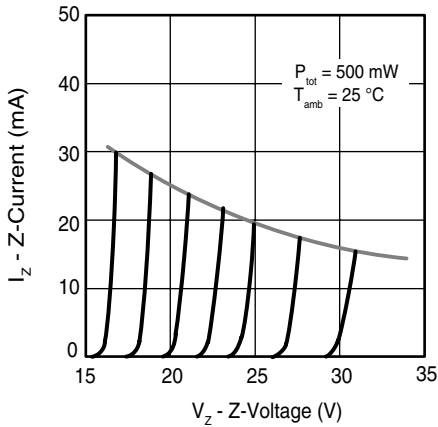

Figure 8. Z-Current vs. Z-Voltage

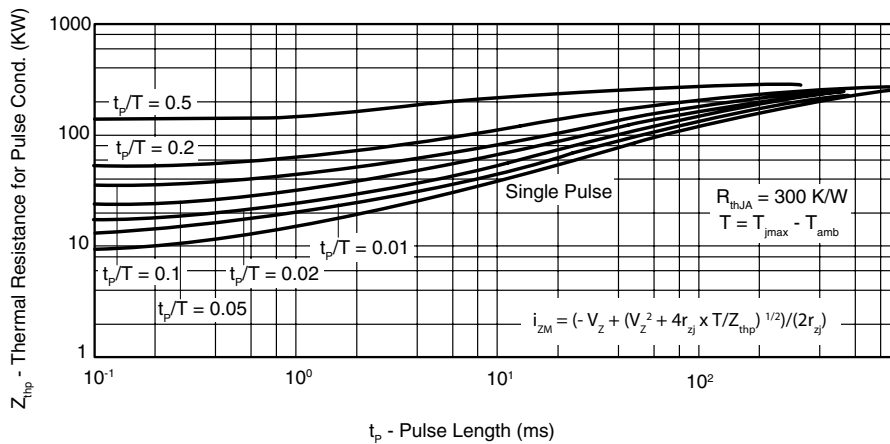

Figure 10. Thermal Response



BZV55B SERIES

500mW.Hermetically Sealed Glass Zener Voltage Rectifiers

ELECTRICAL CHARACTERISTICS (TA=25°C unless otherwise noted)

Type Number	V _Z @ I _{ZT} (Volts)		I _{ZT} mA	Z _{ZT} @ I _{ZT} Ohms Max	I _{ZK} mA	Z _{ZK} @ I _{ZK} Ohms	IR @ VR uA Max	VR V
	V _Z Min (V)	V _Z Max (V)						
BZV55B2V0	1.96	2.04	5	100	1.0	600	50	1.0
BZV55B2V2	2.16	2.24	5	100	1.0	600	50	1.0
BZV55B2V4	2.35	2.45	5	85	1.0	600	50	1.0
BZV55B2V7	2.65	2.75	5	85	1.0	600	10	1.0
BZV55B3V0	2.94	3.06	5	85	1.0	600	4	1.0
BZV55B3V3	3.23	3.37	5	85	1.0	600	2	1.0
BZV55B3V6	3.53	3.67	5	85	1.0	600	2	1.0
BZV55B3V9	3.82	3.98	5	85	1.0	600	2	1.0
BZV55B4V3	4.21	4.39	5	75	1.0	600	1	1.0
BZV55B4V7	4.61	4.79	5	60	1.0	600	0.5	1.0
BZV55B5V1	5.00	5.2	5	35	1.0	550	0.1	1.0
BZV55B5V6	5.49	5.71	5	25	1.0	450	0.1	1.0
BZV55B6V2	6.08	6.32	5	10	1.0	200	0.1	2.0
BZV55B6V8	6.66	6.94	5	8	1.0	150	0.1	3.0
BZV55B7V5	7.35	7.65	5	7	1.0	50	0.1	5.0
BZV55B8V2	8.04	8.36	5	7	1.0	50	0.1	6.2
BZV55B9V1	8.92	9.28	5	10	1.0	50	0.1	6.8
BZV55B10	9.80	10.2	5	15	1.0	70	0.1	7.5
BZV55B11	10.78	11.22	5	20	1.0	70	0.1	8.2
BZV55B12	11.76	12.24	5	20	1.0	90	0.1	9.1
BZV55B13	12.74	13.26	5	26	1.0	110	0.1	10
BZV55B15	14.70	15.30	5	30	1.0	110	0.1	11
BZV55B16	15.68	16.32	5	40	1.0	170	0.1	12
BZV55B18	17.64	18.36	5	50	1.0	170	0.1	13
BZV55B20	19.60	20.40	5	55	1.0	220	0.1	15
BZV55B22	21.56	22.44	5	55	1.0	220	0.1	16
BZV55B24	23.52	24.48	5	80	1.0	220	0.1	18
BZV55B27	26.46	27.54	2	80	1.0	220	0.1	20
BZV55B30	29.40	30.60	2	80	1.0	220	0.1	22
BZV55B33	32.34	33.66	2	80	1.0	220	0.1	24
BZV55B36	35.28	36.72	2	80	1.0	220	0.1	27
BZV55B39	38.22	39.78	2	90	0.5	500	0.1	28
BZV55B43	42.14	43.86	2	90	0.5	600	0.1	32
BZV55B47	46.06	47.94	2	110	0.5	700	0.1	35
BZV55B51	49.98	52.02	2	125	0.5	700	0.1	38
BZV55B56	54.88	57.12	2	135	0.5	1000	0.1	42
BZV55B62	60.76	63.24	2.5	150	0.5	1000	0.1	47
BZV55B68	66.64	69.36	2.5	160	0.5	1000	0.1	51
BZV55B75	73.50	76.50	2.5	170	0.5	1000	0.1	56

VF Forward Voltage = 1.0v Maximum @ IF=100mA for all types.

- Notes:
1. The type numbers listed have zener voltage min/max limits as shown.
 2. The zener impedance is derived from the 60-cycle ac voltage, which results when an ac current having an rms value equal to 10% of the dc zener current (I_{ZT} or I_{ZK}) is superimposed to I_{ZT} or I_{ZK}.