

AVX GiGUARD ESD PROTECTION DIODES

CUTTING EDGE MINIATURE LEADLESS TVS DIODES
FOR ESD PROTECTION OF HIGH SPEED SIGNAL LINES

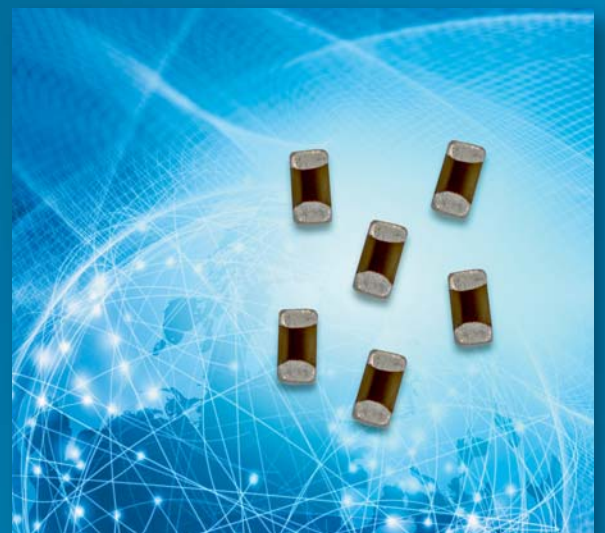

GiGuard - ESD Protection for High Speed Circuits

AVX Bi-directional Leadless Transient Voltage Suppressor Diodes Provide ESD Protection for High Speed Communication and Data Lines



GENERAL DESCRIPTION

Utilizing the latest in TVS Technology combined with a unique leadless package, the new GiGuard series of ESD Suppression Diodes offers Clamping Voltages below 12v and cap values as low as 0.3pfd. This combination of excellence both protects sensitive ICs during ESD events and preserves the integrity of the protected high speed signals. The AVX GG series fits perfectly onto the same PCB solder pads as standard EIA 0201/0402 components.

The GG series complies with IEC 61000-4-2(ESD), Level 4+ ($\pm 20kV$ air, $\pm 20kV$ contact discharge), IEC 61000-4-4 (electrical fast transient -EFT) (20A, 5/50 ns), very fast charged device model (CDM) ESD and cable discharge event (CDE).



APPLICATIONS

- USB 2.0/3.0
- Tablets/Cell Phones Touch Screens
- Network Communications
- Gigabyte Ethernet
- High Def Multimedia Interface (HDMI)
- Mobile Phone Touchscreen

FEATURES

- Low Capacitance (.3pF to 17pF typ)
- Low V_c (<12v @ 1a)
- Bi-Directional protection
- Leadless 0201/0402 case size
- $-55^{\circ}C \sim 125^{\circ}C$ Operating Range

CIRCUIT DIAGRAM

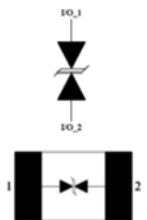

HOW TO ORDER

GG	0201	05	100	N	2	P
Series	Case Size	Voltage Rating	Nominal Cap	Cap Tolerance	Packaging	Finish
	0201 0402	05 = 5.0 V 06 = 6.5 V	0R3 = 0.3pF 2R5 = 2.5pF 5R0 = 5.0pF 100 = 10pF 170 = 17pF	4 = $\pm 2pF$ C = $\pm .25pF$ N = $\pm 30\%$	2 = 7" Reel 0201 = 15K/Reel 0402 = 10K/Reel	P = 100% Tin

ELECTRICAL CHARACTERISTICS

AVX Part Number	V_{rww} (V)	C_{nom} (pF)	Cap (pF)		V_{br} Min (V)	IL (μ a)	P_{pp} (W)	I_{pp} (A)	V_{air} (KV)	V_{con} (KV)	V_c (@8KV) (V)	V_c (@ $I_{pp}=1a$) (V)	V_c (@ I_{pp}) (V)
			Min	Max									
GG020105100N2P	5.0	10	7	13	5.5	<0.1	60	6	± 20	± 20	≤ 12	≤ 8	≤ 12
GG0402060R3C2P	6.5	0.3	0.05	0.6	7.0	<0.1	46	3	± 20	± 20	≤ 30	≤ 12	≤ 15.5
GG0402052R542P	5.0	2.5	0.5	4.5	5.5	<0.1	46	3	± 15	± 15	≤ 16	≤ 12	≤ 15.5
GG0402055R042P	5.0	5	3	7	5.2	<0.1	60	4	± 15	± 15	≤ 15	≤ 12	≤ 16
GG040205100N2P	5.0	10	7	13	5.5	<0.1	96	8	± 25	± 25	≤ 12	≤ 8	≤ 12
GG040205170N2P	5.0	17	11.9	22	5.1	<0.1	80	8	± 30	± 30	≤ 12	≤ 6.5	≤ 10

Characteristic Test Description	Symbol	Units
Nominal Reverse Working Voltage	V_{wrm}	V
Reverse Min. Breakdown Voltage @ 1ma	V_{br}	V
Reverse Leakage Current @ V_{wrm}	IL	ua
Peak Pulse Power (tp=8x20us)	P_{pp}	W
Peak Pulse Current (tp=8x20us)	I_{pp}	A
ESD Rating - Air (150pf, 330 Ω network)	V_{air}	KV
ESD Rating - Contact (150pf, 330 Ω network)	V_{con}	KV

Characteristic Test Description	Symbol	Units
Max Clamp Voltage @ $I_{pp} = 16a$	V_{c16a}	V
Max ESD Clamp Voltage @ 8KV	V_{c8k}	V
Max Clamp Voltage @ $I_{pp} = 1a$	V_c	V
Max Clamp Voltage @ I_{pp}	V_{clpp}	V
Nominal Capacitance ($V_r=0v$, $f=1Mhz$)	C_{nom}	pF
Allowable Capacitance Range	Cap (pF)	min-max

Characteristic Curves - Typical

GG020105100N2P (10PF)

TLP Measurement

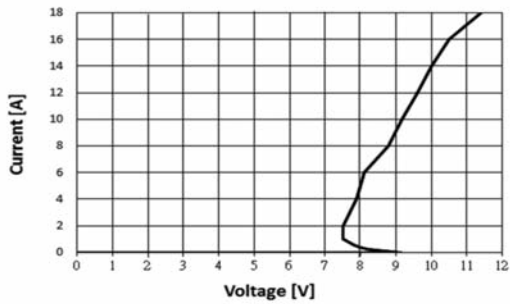

Voltage Sweeping of I/O_1 to I/O_2

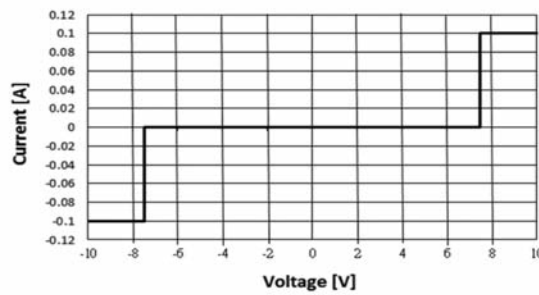

ESD Clamping of I/O_1 to I/O_2
(+8kV Contact per IEC 61000-4-2)

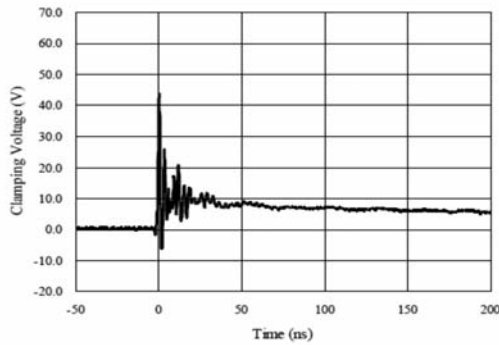

ESD Clamping of I/O_1 to I/O_2
(-8kV Contact per IEC 61000-4-2)

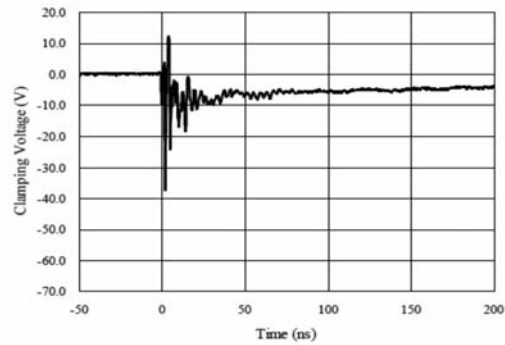

GG0402060R3C2P (0.3PF)

TLP Measurement

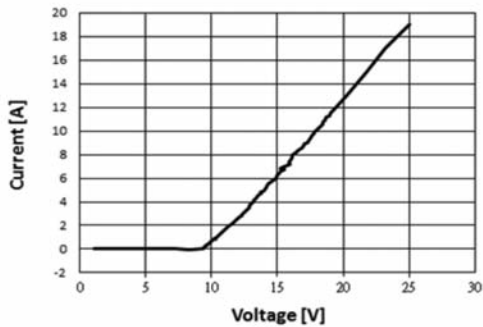

Voltage Sweeping of I/O_1 to I/O_2

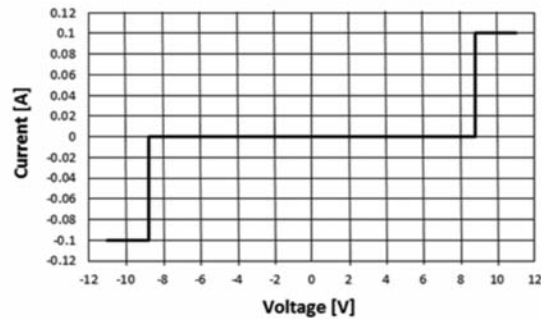

ESD Clamping of I/O_1 to I/O_2
(+8kV Contact per IEC 61000-4-2)

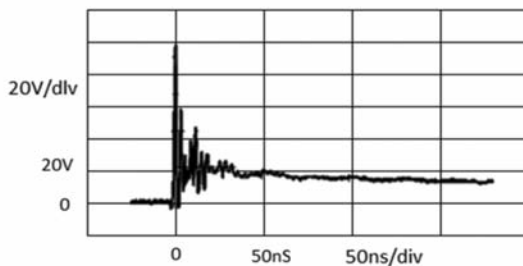

ESD Clamping of I/O_1 to I/O_2
(-8kV Contact per IEC 61000-4-2)

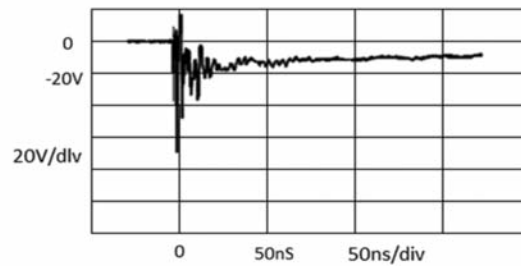

Characteristic Curves - Typical

GG0402052R542P (2.5PF)

TLP Measurement

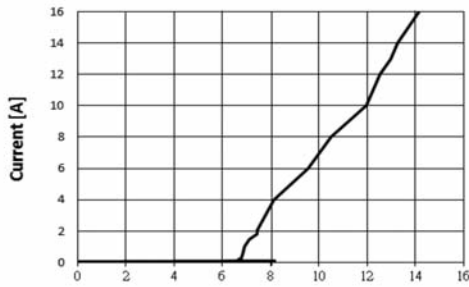

Voltage Sweeping of I/O_1 to I/O_2

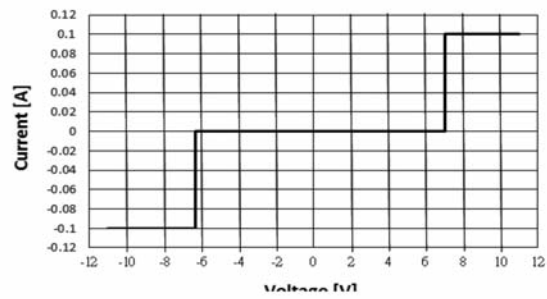

ESD Clamping of I/O_1 to I/O_2
(+8kV Contact per IEC 61000-4-2)

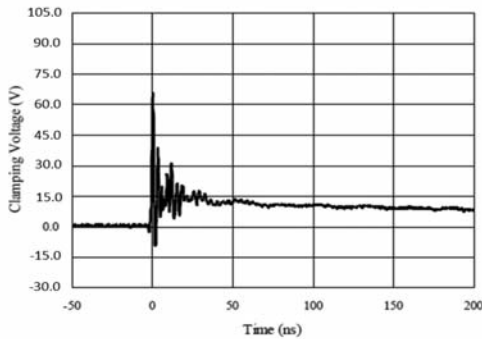

ESD Clamping of I/O_1 to I/O_2
(-8kV Contact per IEC 61000-4-2)

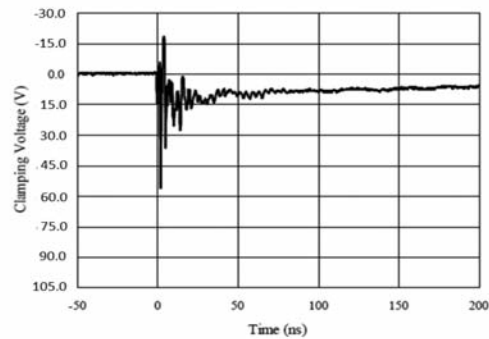

GG0402055R042P (5.0PF)

TLP Measurement of I/O_1 to I/O_2

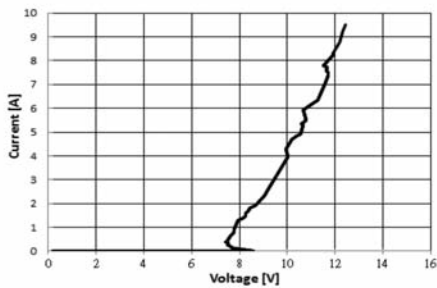

Voltage Sweeping of I/O_1 to I/O_2

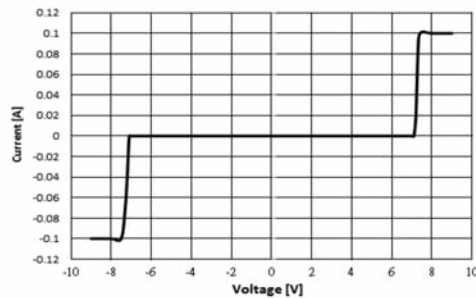

ESD Clamping of I/O_1 to I/O_2
(+8kV Contact per IEC 61000-4-2)

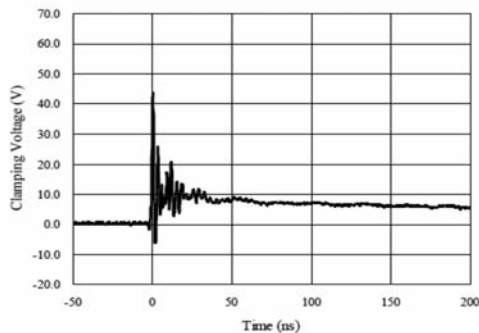

ESD Clamping of I/O_1 to I/O_2
(-8kV Contact per IEC 61000-4-2)

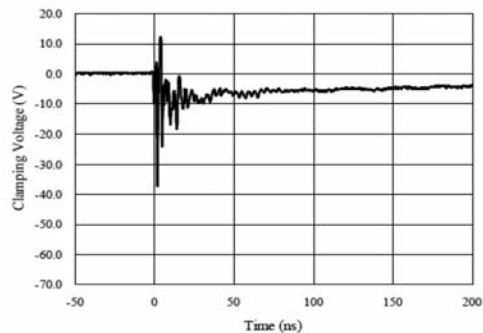

Characteristic Curves - Typical

GG040205100N2P (10PF)

TLP Measurement

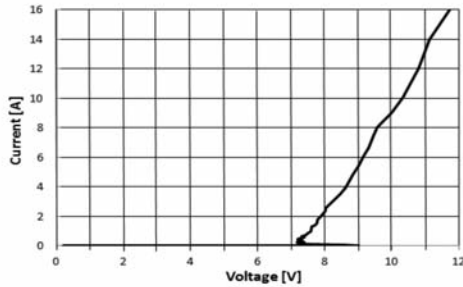

Voltage Sweeping of I/O_1 to I/O_2

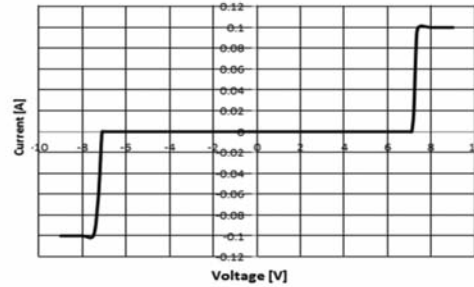

ESD Clamping of I/O_1 to I/O_2
(+8kV Contact per IEC 61000-4-2)

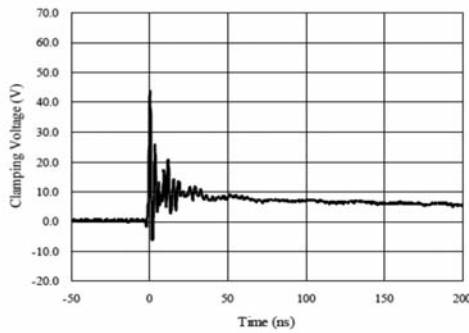

ESD Clamping of I/O_1 to I/O_2
(-8kV Contact per IEC 61000-4-2)

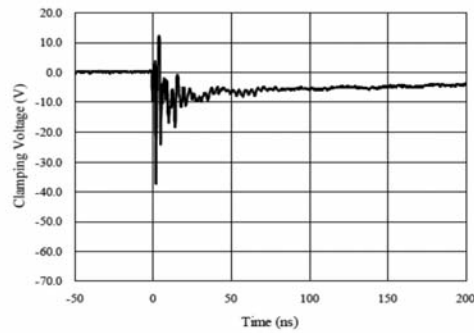

GG040205170N2P (17PF)

TLP Measurement

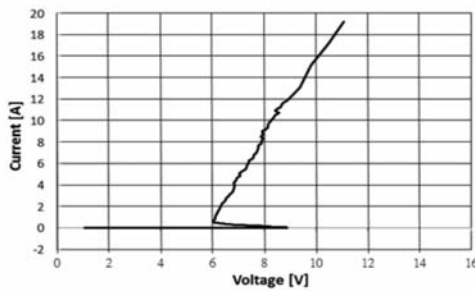

Voltage Sweeping of I/O_1 to

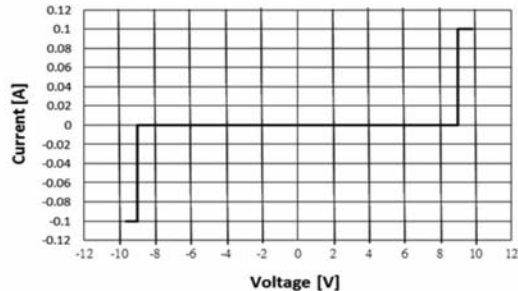

ESD Clamping of I/O_1 to I/O_2
(+8kV Contact per IEC 61000-4-2)

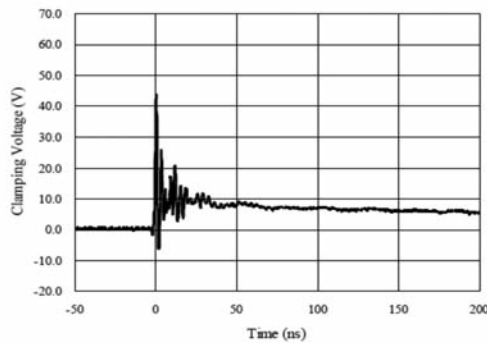

ESD Clamping of I/O_1 to I/O_2
(-8kV Contact per IEC 61000-4-2)

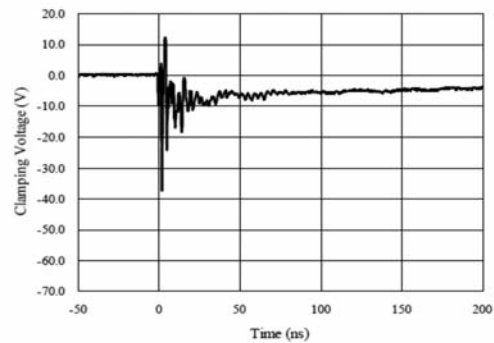

TEMPERATURE DERATING

GG Series Temperature Derating Curve

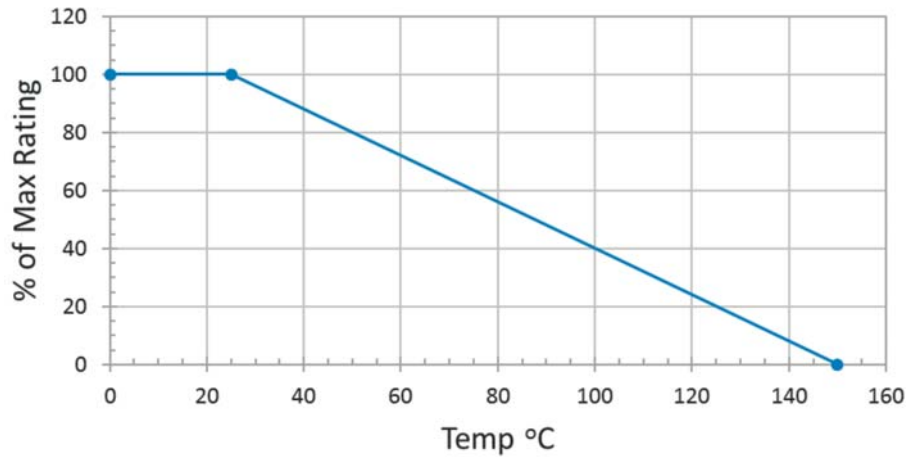

DIMENSIONS

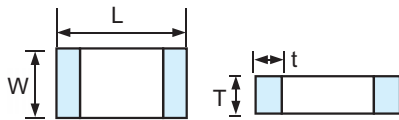

mm (inches)

Size	Length (L)	Width (W)	Thick (T)	Termination (t)
0201	0.60 ± 0.03 (0.024 ± 0.001)	0.30 ± 0.03 (0.012 ± 0.001)	0.30 ± 0.03 (0.012 ± 0.001)	0.15 ± 0.05 (0.006 ± 0.002)
0402	1.00 ± 0.05 (0.039 ± 0.002)	0.60 ± 0.05 (0.024 ± 0.002)	0.50 ± 0.05 (0.020 ± 0.002)	0.20 ± 0.05 (0.008 ± 0.002)

RECOMMENDED REFLOW SOLDER PAD

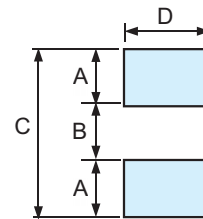

mm (inches)

Size	A	B	C	D
0201	0.25 ± 0.05 (0.010 ± 0.002)	0.30 ± 0.05 (0.012 ± 0.002)	0.80 ± 0.15 (0.031 ± 0.006)	0.275 ± 0.025 (0.011 ± 0.001)
0402	0.61 ± 0.05 (0.024 ± 0.002)	0.51 ± 0.05 (0.020 ± 0.002)	1.70 ± 0.05 (0.067 ± 0.002)	0.51 ± 0.05 (0.020 ± 0.002)

RECOMMENDED SOLDER REFLOW PROFILES

Recommended Reflow Profiles

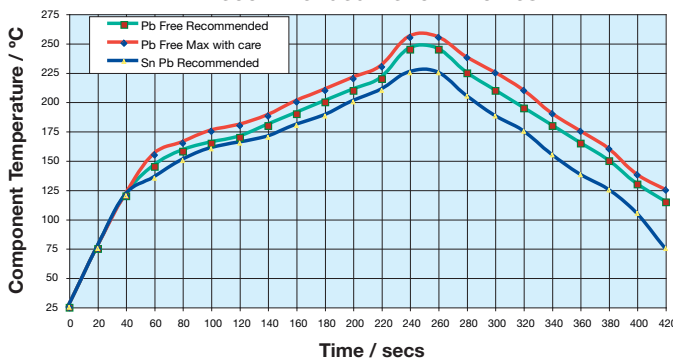

Hand Soldering Cautions

In hand soldering of the Devices. Large temperature gradient between preheated the Devices and the tip of soldering iron may cause electrical failures and mechanical damages such as cracking or breaking of the devices. The soldering shall be carefully controlled and carried out so that the temperature gradient is kept minimum with following recommended conditions for hand soldering.

RECOMMENDED SOLDERING CONDITION 1

- (1) Solder: **0.12~0.18mm** Thread solder (Sn96.5:Ag3.5) with soldering flux in the core Rosin-based and non-activated flux is recommended.
- (2) Preheating: The Devices shall be preheated so that Temperature Gradient between the devices and the tip of soldering iron is 150°C or below.
- (3) Soldering Iron: Rated Power of 20w max with 3mm soldering tip in diameter. Temperature of soldering iron tip **300°Cmax, 3-5sec** (The required amount of solder shall be melted in advance on the soldering tip.)
- (4) Cooling: After soldering. The Devices shall be cooled gradually at room ambient temperature.

RECOMMENDED SOLDERING CONDITION 2 – WITHOUT PREHEATING

- (1) Temperature of soldering iron tip 300°Cmax, 3-5sec.
- (2) Solder iron tip shall not directly touch to Devices.
- (3) Solder iron tip shall be fully preheated before soldering while soldering iron tip to the external electrode of Devices.

PACKAGING SPECIFICATION

- Carrier tape and transparent cover tape should be heat-sealed to carry the products, and the reel should be used to reel the carrier tape.
- The adhesion of the heat-sealed cover tape shall be 25~60 grams with nominal of 40 grams.
- Both the head and the end portion of the taping shall be empty for reel package and SMT auto-pickup machine. And a normal paper tape shall be connected in the head of taping for the operator to handle.

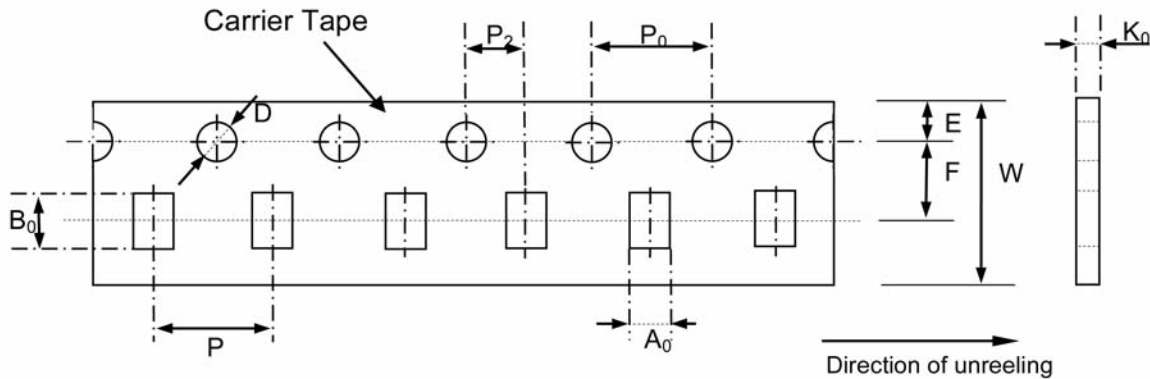

mm (inches)

Case Size	A_0 ± 0.05 (0.002)	B_0 ± 0.05 (0.002)	K_0 ± 0.05 (0.002)	D $+0.10$ (0.004) -0.05 (0.002)	P ± 0.10 (0.004)	P_2 ± 0.10 (0.004)	P_0 ± 0.10 (0.004)	W ± 0.10 (0.004)	E ± 0.10 (0.004)	F ± 0.05 (0.002)	Qty
0201	0.37 (0.015)	0.67 (0.026)	0.50 (0.020)	1.50 (0.059)	2.00 (0.079)	2.00 (0.079)	4.00 (0.157)	8.00 (0.315)	1.75 (0.069)	3.50 (0.138)	15K
0402	0.70 (0.028)	1.12 (0.044)	0.60 (0.024)	1.55 (0.061)	2.00 (0.079)	2.00 (0.079)	4.00 (0.157)	8.00 (0.315)	1.75 (0.069)	3.50 (0.138)	10k

REEL DIMENSIONS

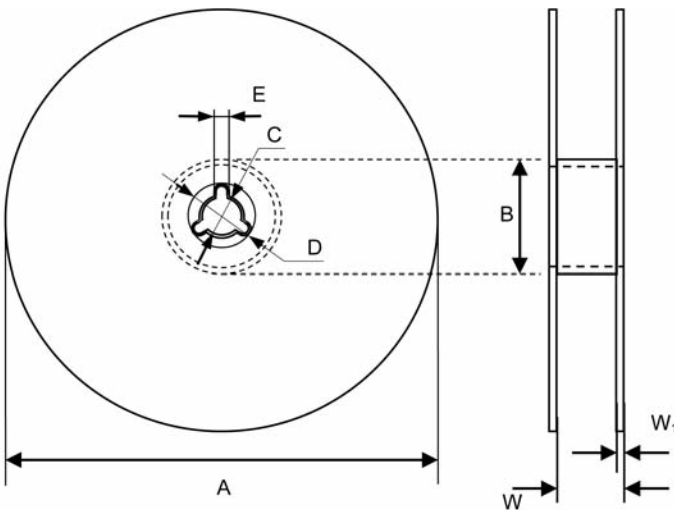

mm (inches)

Reel Size	A	B	C	D	E	W	W_1
7"	178.0 ± 1.0 (7.008 ± 0.039)	60.0 ± 0.5 (2.362 ± 0.020)	13.0 ± 0.2 (0.512 ± 0.008)	21.0 ± 0.2 (0.827 ± 0.008)	2.0 ± 0.5 (0.079 ± 0.020)	9.0 ± 0.50 (0.354 ± 0.020)	1.5 ± 0.15 (0.059 ± 0.006)

AMERICAS

AVX Greenville, SC
Tel: 864-967-2150

EUROPE

AVX Limited, England
Tel: +44-1276-697000

AVX S.A.S., France
Tel: +33-1-69-18-46-00

AVX GmbH, Germany
Tel: +49-0811-95949-0

AVX SRL, Italy
Tel: +39-02-614-571

AVX Czech Republic
Tel: +420-57-57-57-521

AVX/ELCO UK
Tel: +44-1638-675000

ELCO Europe GmbH
Tel: +49-2741-299-0

AVX S.A., Spain
Tel: +34-91-63-97-197

AVX Benelux
Tel: +31-187-489-337

ASIA-PACIFIC

AVX/Kyocera (S) Pte Ltd.,
Singapore
Tel: +65-6286-7555

AVX/Kyocera, Asia, Ltd.,
Hong Kong
Tel: +852-2363-3303

AVX/Kyocera Yuhan Hoesa,
South Korea
Tel: +82-2785-6504

AVX/Kyocera HK Ltd.,
Taiwan
Tel: +886-2-2656-0258

AVX/Kyocera (M) Sdn Bhd,
Malaysia
Tel: +60-4228-1190

AVX/Kyocera International
Trading Co. Ltd.,
Shanghai
Tel: +86-21-3255 1933

AVX/Kyocera Asia Ltd.,
Shenzen
Tel: +86-755-3336-0615

AVX/Kyocera International
Trading Co. Ltd.,
Beijing
Tel: +86-10-6588-3528

AVX/Kyocera India
Liaison Office
Tel: +91-80-6450-0715

Japan

AVX/Japan
Tel: +81-740-32-1250

Contact:

