



# WS58P20SMB-BH

## Power Transient Voltage Suppressor

### Features

- 2000 watts Peak Pulse Power (10/1000 $\mu$ s)
- Bidirectional Protection
- Fast Response Time : Typically < 1ns
- Excellent Clamping Capability
- Glass Passivated Junction
- Built-in Strain relief
- Low inductance
- Low profile package
- High temperature solder:260°C/10 seconds at terminal

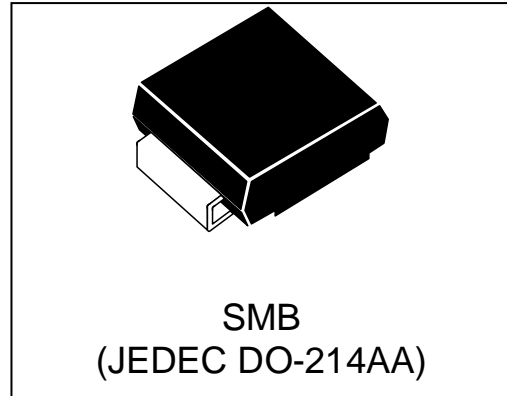

### Mechanical Characteristics

- JEDEC DO-214AA package
- Molding compound flammability rating: UL 94V-0
- Marking: Marking Code
- Packaging : Tape and Reel per EIA 481
- RoHS Compliant

### Applications

- I/O Interfaces
- Power lines
- Automotive and Telecommunication
- Computers & Consumer Electronics
- Industrial Electronics

Absolute Maximum Rating			
Rating	Symbol	Value	Units
Peak Pulse Power (tp =10/1000 $\mu$ s) (see Note1,2)	P <sub>PPM</sub>	2000	Watts
Peak pulse current (10/1000 $\mu$ s) (see Note2)	I <sub>PP</sub>	22.0	A
Power Dissipation on infinite heat sink T <sub>L</sub> = 50 °C (Fig4)	P <sub>D</sub>	6.5	W
Operating Junction Temperature range	T <sub>J</sub>	-65 to + 150	°C
Storage Temperature range	T <sub>STG</sub>	-65 to + 150	°C

**Note1:** Peak Pulse Power Rating as Pulse Width ,per Fig1.

**Note2:** Peak Pulse Power or Current Derated above T<sub>A</sub>=25°C Per Fig. 2 and Non-Repetitive Current Pulse,Per Fig.3.

### Pin Configuration

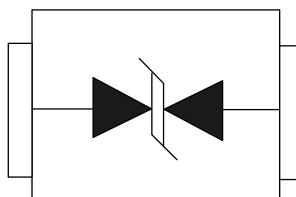

### Electrical Characteristics

Symbol	Parameter
$I_{PP}$	Maximum Reverse Peak Pulse Current
$V_C$	Clamping Voltage @ $I_{PP}$
$V_{RWM}$	Working Peak Reverse Voltage
$I_R$	Maximum Reverse Leakage Current @ $V_{RWM}$
$V_{BR}$	Breakdown Voltage @ $I_T$
$I_T$	Test Current

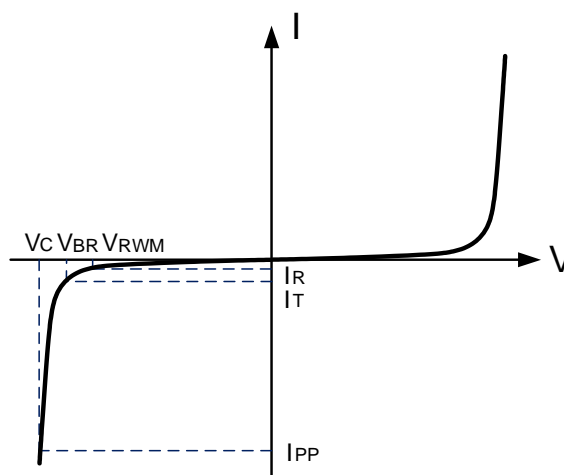

WS58P20SMB-BH						
Parameter	Symbol	Conditions	Minimum	Typical	Maximum	Units
Reverse Stand-Off Voltage	$V_{RWM}$				58	V
Reverse Breakdown Voltage	$V_{BR}$	$I_T=1mA$	62		71.2	V
Reverse Leakage Current	$I_R$	$V_{RWM}=58V, T=25^{\circ}C$			1	$\mu A$
Clamping Voltage	$V_C$	$I_{PP}=22.0A, t_p=10/1000\mu s$			93.6	V

Typical Characteristics

Figure 1: Peak Pulse Power Rating Curve

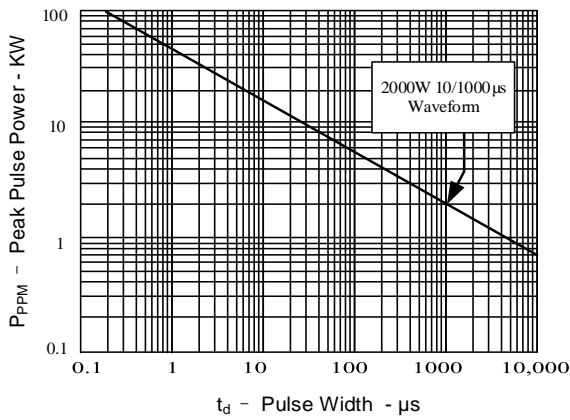

Figure 2: Pulse Derating Curve

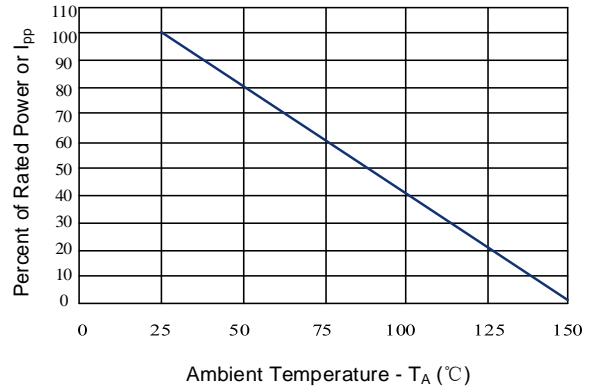

Figure 3: Pulse Waveform

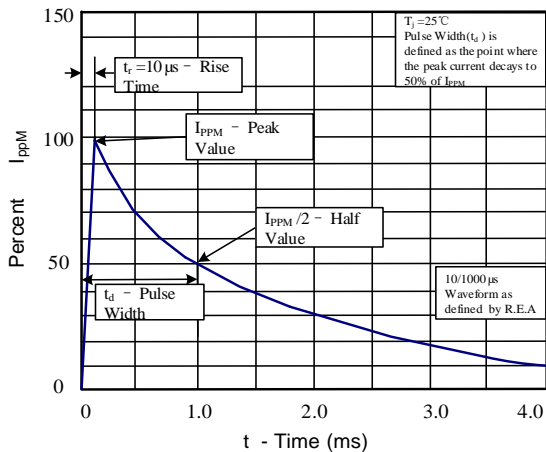
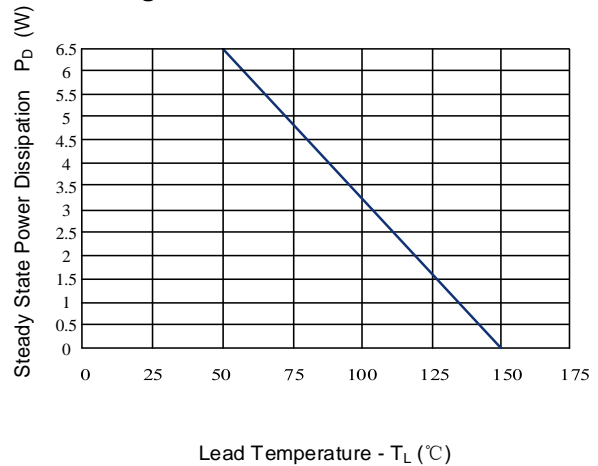
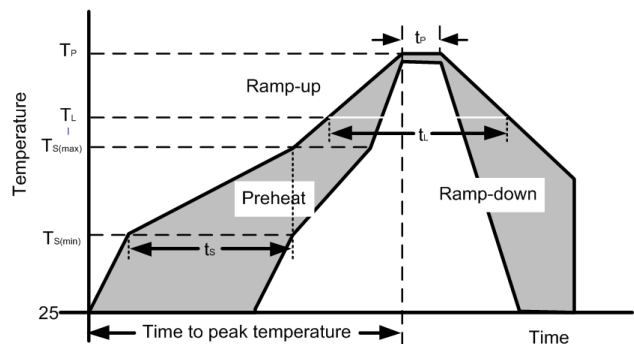

Figure 4: Steady State Power Dissipation Derating Curve



Recommended Soldering Parameters

Reflow Condition		
Pre-Heat	Temperature min ( $T_{s(min)}$ )	150°C
	Temperature max ( $T_{s(max)}$ )	200°C
	Time (min to max) ( $t_s$ )	60-190 s
Average ramp up rate (Liquidus Temp) ( $T_L$ ) to peak		3°C/s max
Ts(max) to TL - Ramp-up Rate		3°C/s max
Reflow	Temperature ( $T_L$ ) (Liquidus)	217°C
	Temperature ( $t_L$ )	60-150 s
Peak Temperature ( $T_P$ )		260 <sup>+0/-5</sup> °C
Time within actual peak Temperature ( $t_p$ )		20-40 s
Ramp-down Rate		5°C/s max
Time 25°C to peak Temperature ( $T_P$ )		8 minutes max
Do not exceed		260°C



### Outline Drawing – SMB(DO-214AA)

Ref. (mm)	Millimeters	
	Min.	Max.
A	2.130	2.600
A1	-	0.300
B	1.900	2.200
E	4.100	4.750
E1	5.210	5.590
D	3.300	3.940
L	0.760	1.520

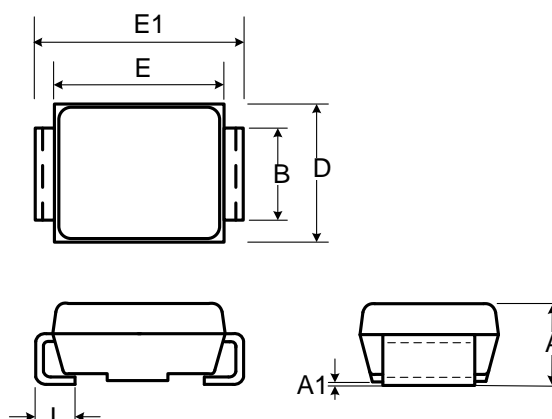

### Recommended Solder Pad Layout

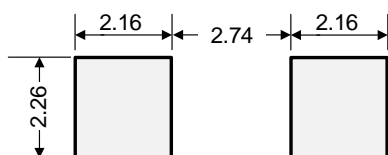

Dimensions in mm

### Marking Code



### Package Information

Package Type	Description	Quantity (pcs)
SMB(DO-214AA)	Tape & Reel -12mm/13" tape	3000

### Contact Information

No.1001, Shiwan(7) Road, Pudong District, Shanghai, P.R.China.201207

Tel: 86-21-68969993 Fax: 86-21-50757680 Email: market@way-on.com

WAYON website: <http://www.way-on.com>

For additional information, please contact your local Sales Representative.

**WAYON** ® are registered trademarks of Wayon Corporation.

*Specifications are subject to change without notice.  
The device characteristics and parameters in this data sheet can and do vary in different applications and actual device performance may vary over time.  
Users should verify actual device performance in their specific applications.*