



深圳市首韩科技有限公司

SHENZHEN SHOUHAN TECHNOLOGY CO., LTD

Tel: 0755-27597601 Fax: 0755-27597491

# 承 认 书

## SPECIFICATION FOR APPROVAL

客户 Customer:

\_\_\_\_\_

首韩型号:

DC031TP

\_\_\_\_\_

厂家型号:

DC031-1.3

\_\_\_\_\_

贵公司承认印 Approval signatures

料号/Part No.	签章/Signatures

日期 Date:

拟制/Drawn	李春风	
审核/Check	张栋	
批准/Approved	罗孝金	



品名 (NAME) : DC座
型号 (MODEL): DC-031TP
1.溫度5~35°C, 湿度45~85%標準狀態下測試。 In normal fettle to test. Temperature 5~35°C and humidity 45~85%
2.溫度 -30~70°C環保內使用。 In entirionment of temperature -30~70°C

ITEM 專案	TEST CONDITION 測試條件	SPECIFICICAION 規格
---------	---------------------	-------------------

### 3.ELECTRONICAL RESISTAN 電氣性能

3.1	CONTACT RESISANCE 接觸阻抗	Being measured at 1KHZsmall current connact resistance meter.在1KHZ小電流下測量。	0.03欧姆以下
3.2	INSULATION RESISTANCE 絕緣阻抗	Measurements shall be made following application of DC500V potenrial across terminals and across terminals and frame for 1minute.在端子之間和端子與殼之間加DC500V條件下，持續1分鐘測量。	100M min 100兆歐以上。
3.3	WITHSTAND VOLTAGE 耐電壓	AC500V(50HZ or 60HZ) shall be applied across terminals and across terminals and frame for one minute.在端子之間和端子與殼之間加AC500V條件下，持續1分鐘測量。	There shall be no breakdown 無擊穿現象。

### 4.MECHANICAL CHARACTERISTICS 機械性能

4.1	INSERION AND WITHDRAW 插拔力	Being measure at across spring piece and across matching plug for ergometer.用測力計在插頭與彈片之間進行測試	Insertion and extraction force 3-20N, 插拔力3-20N
4.2	TERMINAL STRENGTH 端子強度	A static force of 500gf being applied in one directionon the top of terminal for 1 minute.一個500克之靜負荷施加於端子頂部的一個方向持續1分鐘。	There shall be no sign of damage mechanical and electriclly. 無任何迹象顯示機械及電器性能之損壞。



## 5. DURABILTY 耐久 性

5.1	<b>SOLDERING TEST</b> 可韓性試驗	The top of terminals shall be dipped 2mm in the loder bath at a temperature of $230\pm 5^{\circ}\text{C}$ for 3sec. 端子頂部被浸入韓池2mm深，溫度 $230\pm 5^{\circ}\text{C}$ 時間3秒	A new un form coating of shall cover above 75% of the surface being immersed. 浸入的部分75%以上表面將被錫覆蓋。
5.2	<b>LIFE TEST</b> 壽命試驗	5000 cycles of operation at rate of 20-30 cycles per minture with unloading. 無負載條件下，每分鐘20—30次的速度操作5000次。	(1) Contact resistance. $40\text{m}\Omega$ max 接觸阻抗40毫歐以下 (2) Drive fore 30 inital value 動作力變化範圍初始值30 (3) ITEM專案—3.2 (4) ITEM專案—3.3 (5) INEM—4.2
5.3	<b>HEAT TEST</b> 耐熱試驗	$80\pm 2^{\circ}\text{C}$ for 48 hours after test keep in normal condition for 30minutes. 在 $80\pm 2^{\circ}\text{C}$ 環境中放48小時，再放在正常環境中30分鐘後進行測試。	(1) Contact resistance $50\text{m}\Omega$ max. 接觸電阻50毫歐以下
5.4	<b>HUMIDITY TEST</b> 耐濕試驗	The condition of temperature $40\pm 2^{\circ}\text{C}$ and humidity 90-95% for 48 hours after test keep in normal condition for 30 min. 在 $40\pm 2^{\circ}\text{C}$ 90—95% Rh環境中放48小時，再放在正常環境中30分鐘後進行測試。	(2) Insulation resistance $100\text{M}\Omega$ min 絕緣電阻100M歐以上 (3) There shall be no sign of damage mechanically and electrically. 無任何 迹象顯示機械及電器性能之損壞。
5.5	<b>COLD TEST</b> 耐冷試驗	At $-30\pm 2^{\circ}\text{C}$ for 48 hours, after test keep in normal condition for 30 min. 在 $-30\pm 2^{\circ}\text{C}$ 環境中放48小時，再置於正常環境中30分鐘後進行測試。	

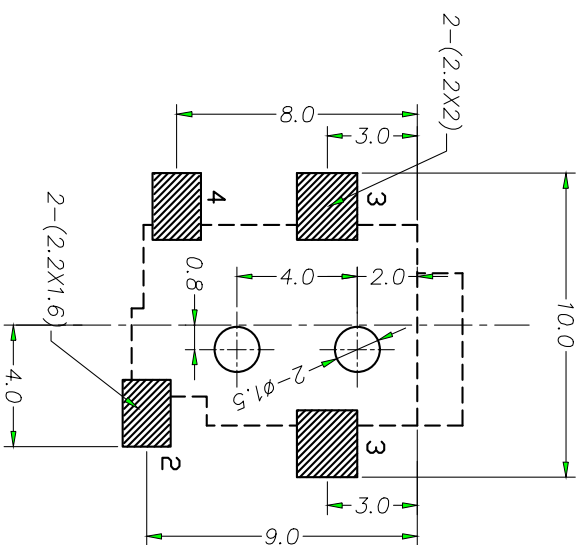
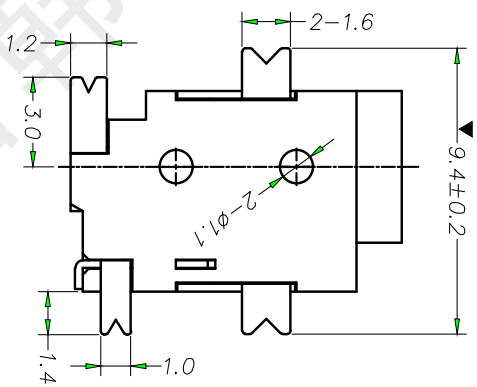
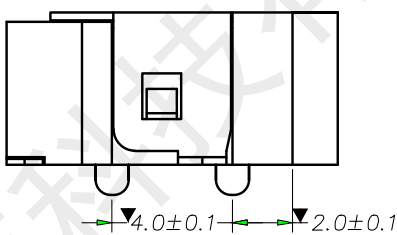
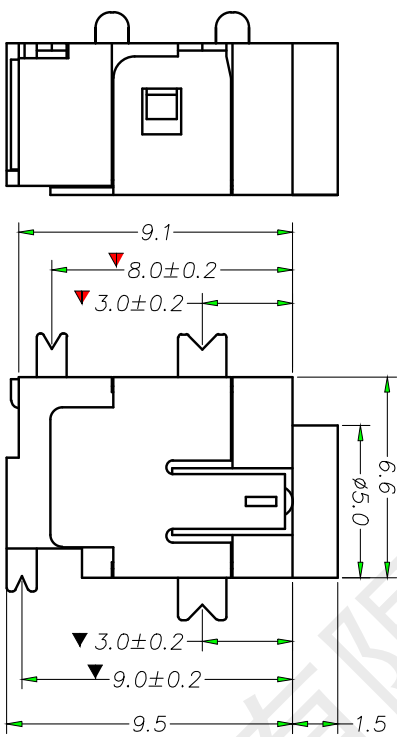
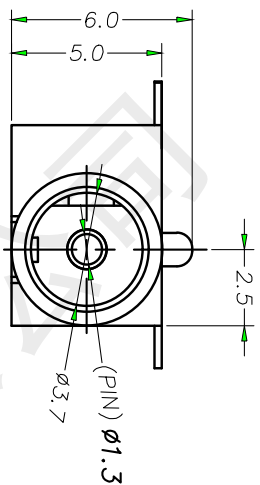

P.C.B LAYOUT TOP VIEW

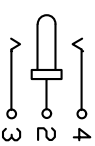
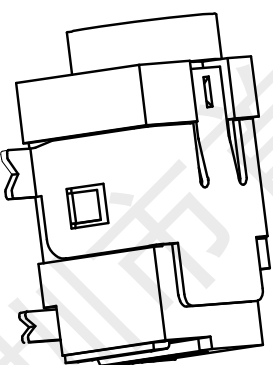
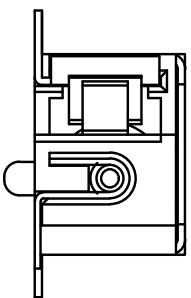

SCHEMATIC

序号	产品编号	产品名称	数量	材料	规格	电镀
1	DC-018-01	底座	1	PPA(黑色)		镀银
2	DC-018-02	盖脚	1	黄铜	0.25T	镀银
3	DC-018-03	弹片	1	磷青	0.25T	镀银
4	DC-018-04	圆针	1	黄铜		镀银

主要技术性能

额定电流	接触电阻	绝缘电阻	耐压	插拔力	使用温度范围	使用寿命
DC 30V/0.5A	$\leq 0.03\Omega$	$\geq 100M\Omega$	AC500V(50Hz)/min	3-20N	-30-70°C	5000次

公差

长度	直径	角度
X. ± 0.20	X. ± 0.10	X. ± 2°

部门会签

装配部	市场部
张栋	第 1 张
张栋	第 1 张

DC-031TP

DC电源插座

首韩科技 深圳市首韩科技有限公司