

Specifications

- Current rating:3A AC,DC
- Voltage rating:250V AC,DC
- Temperature range:-40°C~+105°C
- Contact resistance:10mΩMax.
- Insulation resistance:1000MΩMin.
- Withstanding voltage:800V AC/minute
- *Compliant with RoHS and REACH*
- *Meet the HF/Halogen Free,need to customize*
- *Contact CJT for details*

Standards



Assembly layout

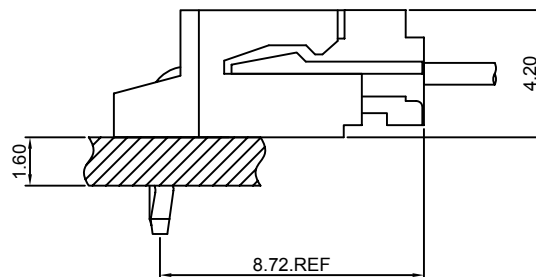
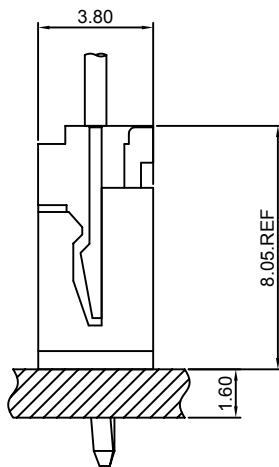



A2502 SERIES

2.50mm pitch wire to board connector

A2502-T

2.50mm pitch Crimp Terminal

Reference Informations:

*Used in CJT A2502H-XP,A2511H-XP series Housing

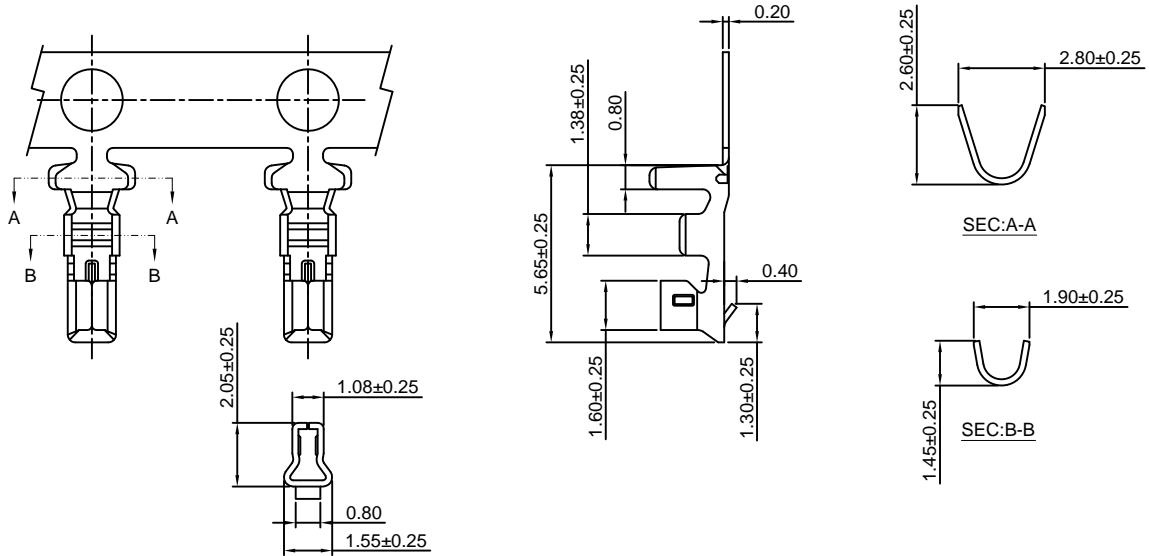

Ordering information & Specifications

Unit:mm

Part NO.	Wire Range	Insulation O.D.	Material	Finish	Qty/reel
A2502-TP	AWG#22-#30	1.90mm(max)	Phosphor Bronze	Tin over Nickel	10,000 PCS
A2502-GP	AWG#22-#30	1.90mm(max)	Phosphor Bronze	Gold over Nickel	10,000 PCS

Optional Gold plating available but MOQ requested

A2502H-XP

2.50mm pitch Housing

Reference Informations:

*Material:Nylon 66,UL94V-0

*Suitable CJT A2502-T series Terminal

*Mates with CJT A2502WV,WR-XP series Wafer

*Color:White

Ordering Information:

A2502H-XP - *** - **
1 2 3

1.Part No.

2.Material:

(Blank):Nylon 66,UL94V-0

GWT:Nylon 66,UL94V-0,GWT 750°C

3.Color:

(Blank):White

RD:Red

YL:Yellow

BL:Blue

BK:Black

GN:Green

TR:Tomato red

LE:Light blue

OR:Orange

GY:Gray

PK:Pink

BR:Brown

VI:Violet

LY:Lemon yellow

VY:Vivid yellow

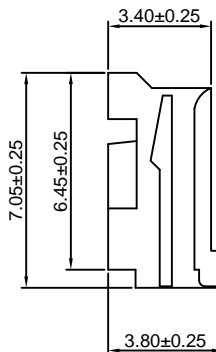
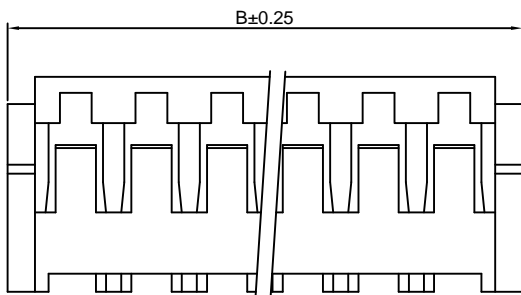
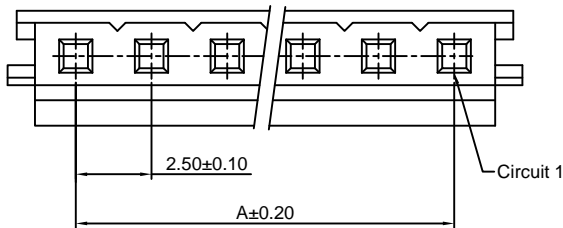
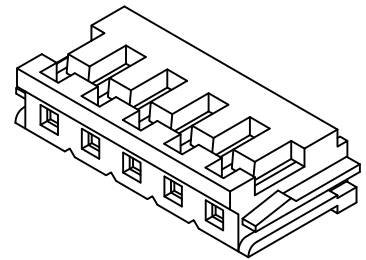

Ordering Information & Dimensions

PART NO.	Dimensions	
	A	B
2P	2.50	7.00
3P	5.00	9.50
4P	7.50	12.00
5P	10.00	14.50
6P	12.50	17.00
7P	15.00	19.50
8P	17.50	22.00
9P	20.00	24.50
10P	22.50	27.00
11P	25.00	29.50
12P	27.50	32.00
13P	30.00	34.50
14P	32.50	37.00
15P	35.00	39.50

Unit: mm



A2502 SERIES

2.50mm pitch wire to board connector

A2502HWV-XP

2.50mm pitch Housing

Reference Informations:

- *Material: Pin: Phosphor Bronze/Tin over Nickel
Insulator: PBT, UL94V-0
- *Mates with CJT A2502WVA, WRA-XP, A2502WVB, WRB-XP, A2502WVA-N, WRA-N-XP, A2502WVB-N, WRB-N-XP series Wafer
- *Color: Gray

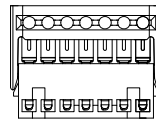
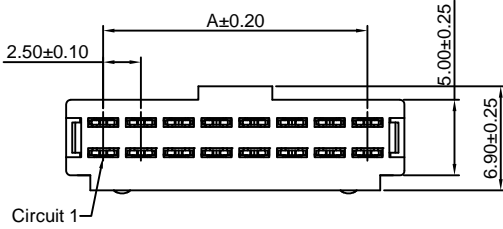

2P~7P

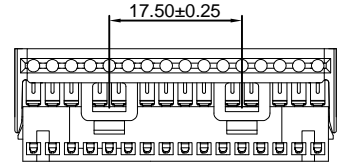

16P~20P

Ordering Information:
A2502HWV-XP - *** - **
1 2 3

1. Part No.
2. Material:
(Blank): PBT, UL94V-0
GWT: PBT, UL94V-0, GWT 750°C
3. Finish:
(blank): Tin over Nickel
G: Gold over Nickel

Ordering Information & Dimensions

PART NO.	Dimensions	
	A	B
2P	2.50	7.40
3P	5.00	9.90
4P	7.50	12.40
5P	10.00	14.90
6P	12.50	17.40
7P	15.00	19.90
8P	17.50	22.40
9P	20.00	24.90
10P	22.50	27.40
11P	25.00	29.90
12P	27.50	32.40
13P	30.00	34.90
14P	32.50	37.40
15P	35.00	39.90
16P	37.50	42.40
17P	40.00	44.90
18P	42.50	47.40
19P	45.00	49.90
20P	47.50	52.40

Unit: mm

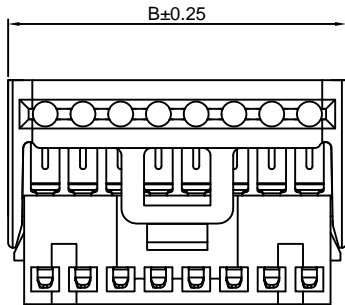

8P~15P

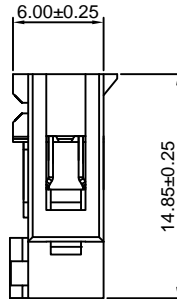

A2502WV-XP

2.50mm pitch 180° Wafer

Reference Informations:

- *Material: Pin: Brass/Tin over Nickel
Insulator: Nylon 66, UL94V-0
- *Mates with CJT A2502H-XP series Housing
- *Color: White

Ordering Information:
A2502WV-XP - * - *** - ** - **
1 2 3 4 5

1. Part No.
2. Style
(blank): Type 1
2: Type 2
3. Material:
(Blank): Nylon 66, UL94V-0
GWT: Nylon 66, UL94V-0, GWT 750°C
4. Color:
(Blank): White
RD: Red
BL: Blue
GN: Green
YL: Yellow
BK: Black
5. Finish:
(blank): Tin over Nickel
G: Gold over Nickel

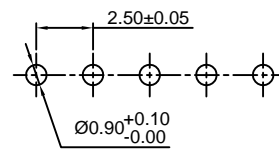
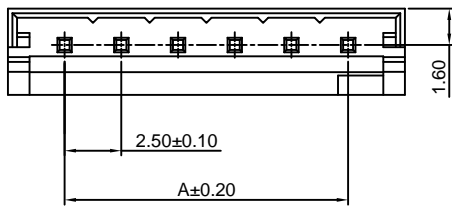

P.C.B LAYOUT

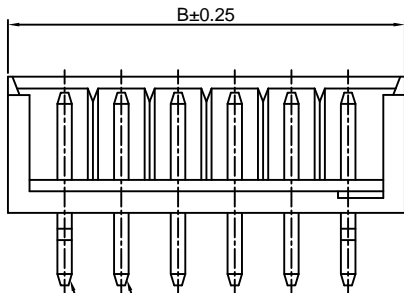
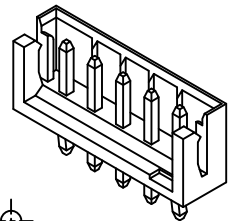

Circuit 1

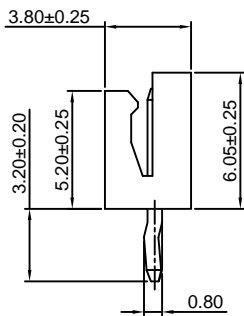

TYPE 1

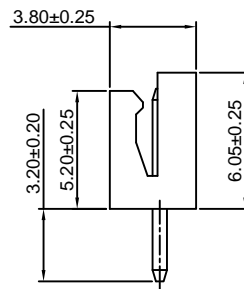

TYPE 2

Ordering Information & Dimensions

PART NO.	Dimensions	
	A	B
2P	2.50	7.50
3P	5.00	10.00
4P	7.50	12.50
5P	10.00	15.00
6P	12.50	17.50
7P	15.00	20.00
8P	17.50	22.50
9P	20.00	25.00
10P	22.50	27.50
11P	25.00	30.00
12P	27.50	32.50
13P	30.00	35.00
14P	32.50	37.50
15P	35.00	40.00

Unit: mm

A2502WR-XP

2.50mm pitch 90° Wafer

Reference Informations:

- *Material:Pin:Brass/Tin over Nickel
Insulator:Nylon 66,UL94V-0
- *Mates with CJT A2502H-XP series Housing
- *Color:White

Ordering Information:

A2502WR-XP - * - *** - ** - **
1 2 3 4 5

- 1.Part No.
- 2.Style
(blank):Type 1
2:Type 2
- 3.Material:
(Blank):Nylon 66,UL94V-0
GWT:Nylon 66,UL94V-0,GWT 750 °C
- 4.Color:
(Blank):White
RD:Red OR:Orange
YL:Yellow GY:Gray
BL:Blue PK:Pink
BK:Black BR:Brown
GN:Green VJ:Violet
TR:Tomato red LY:Lemon yellow
LE:Light blue VY:Vivid yellow
- 5.Finish:
(blank):Tin over Nickel
G:Gold over Nickel

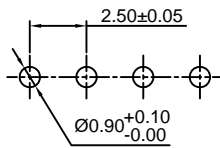
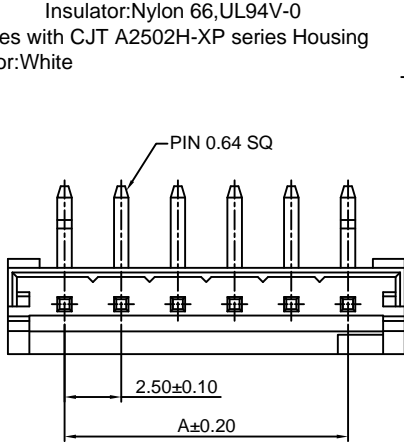
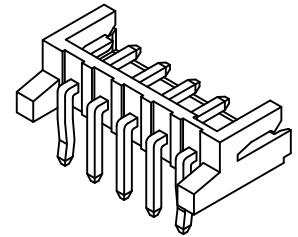

P.C.B LAYOUT

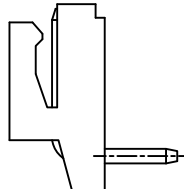

TYPE 2

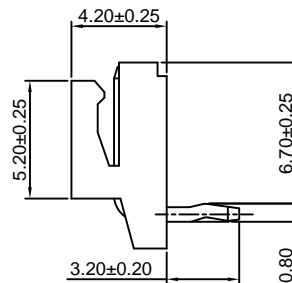
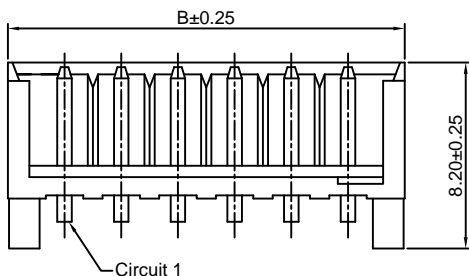

TYPE 1

Ordering Information & Dimensions

PART NO.	Dimensions	
	A	B
2P	2.50	7.50
3P	5.00	10.00
4P	7.50	12.50
5P	10.00	15.00
6P	12.50	17.50
7P	15.00	20.00
8P	17.50	22.50
9P	20.00	25.00
10P	22.50	27.50
11P	25.00	30.00
12P	27.50	32.50
13P	30.00	35.00
14P	32.50	37.50
15P	35.00	40.00

Unit: mm

A2502WVA-XP

2.50mm pitch 180° Wafer

Reference Informations:

- *Material:Pin:Brass/Tin over Nickel
Insulator:PBT+15%GF,UL94V-0
- *Mates with CJT A2502HWV-XP series Housing
- *Color:Gray

Ordering Information:

A2502WVA-XP - *** - **
1 2 3

- 1.Part No.
- 2.Material:
(Blank):PBT,UL94V-0
GWT:PBT,UL94V-0,GWT 750 °C
- 3.Finish:
(blank):Tin over Nickel
G:Gold over Nickel

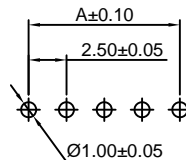
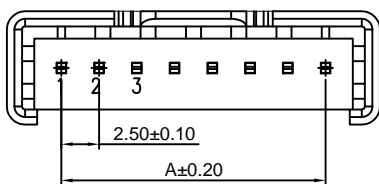

P.C.B LAYOUT

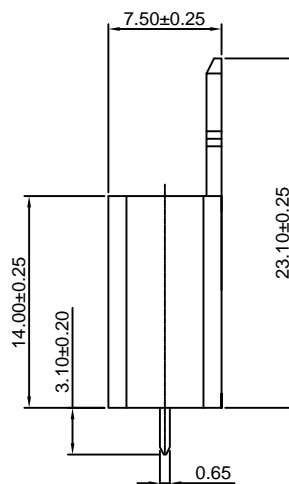
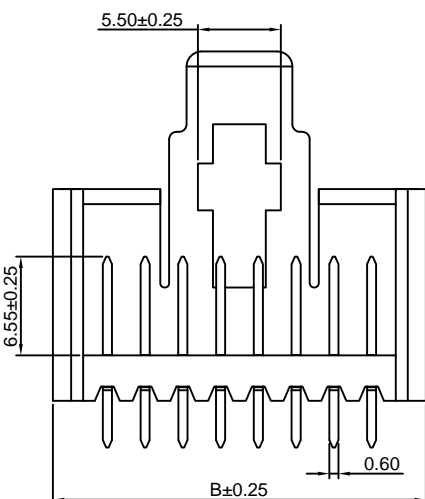

Ordering Information & Dimensions

PART NO.	Dimensions	
	A	B
2P	2.50	9.70
3P	5.00	12.20
4P	7.50	14.70
5P	10.00	17.20
6P	12.50	19.70
7P	15.00	22.20
8P	17.50	24.70
9P	20.00	27.20
10P	22.50	29.70
11P	25.00	32.20
12P	27.50	34.70
13P	30.00	37.20
14P	32.50	39.70
15P	35.00	42.20
16P	37.50	44.70
17P	40.00	47.20
18P	42.50	49.70
19P	45.00	52.20
20P	47.50	54.70

Unit: mm

A2502WRA-XP

2.50mm pitch 90° Wafer

Reference Informations:

- *Material:Pin:Brass/Tin over Nickel
Insulator:PBT+15%GF,UL94V-0
- *Mates with CJT A2502HWV-XP series Housing
- *Color:Gray

Ordering Information:
A2502WRA-XP - *** - **
1 2 3

- 1.Part No.
- 2.Material:
(Blank):PBT,UL94V-0
GWT:PBT,UL94V-0,GWT 750 °C
- 3.Finish:
(blank):Tin over Nickel
G:Gold over Nickel

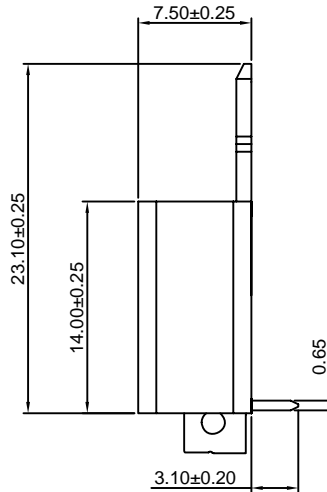
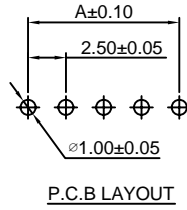
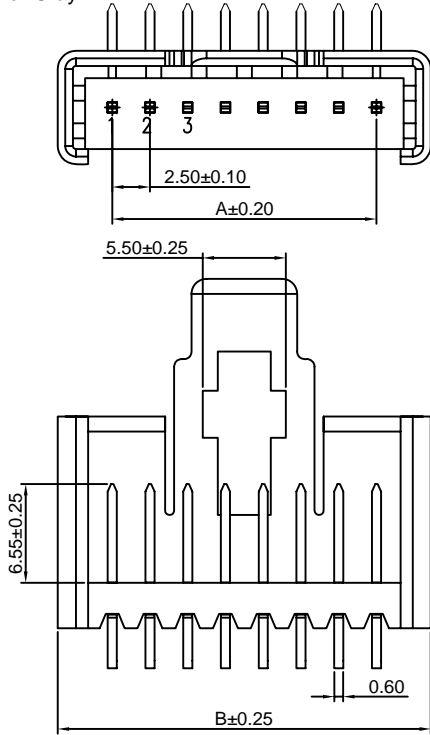

Ordering Information & Dimensions

PART NO.	Dimensions	
	A	B
2P	2.50	9.70
3P	5.00	12.20
4P	7.50	14.70
5P	10.00	17.20
6P	12.50	19.70
7P	15.00	22.20
8P	17.50	24.70
9P	20.00	27.20
10P	22.50	29.70
11P	25.00	32.20
12P	27.50	34.70
13P	30.00	37.20
14P	32.50	39.70
15P	35.00	42.20
16P	37.50	44.70
17P	40.00	47.20
18P	42.50	49.70
19P	45.00	52.20
20P	47.50	54.70

Unit: mm

A2502WVA-N-XP

2.50mm pitch 180° Wafer

Reference Informations:

- *Material:Pin:Brass/Tin over Nickel
Insulator:PBT+15%GF,UL94V-0
- *Mates with CJT A2502HWV-XP series Housing
- *Color:Gray

Ordering Information:
A2502WVA-N-XP - *** - **
1 2 3

- 1.Part No.
- 2.Material:
(Blank):PBT,UL94V-0
GWT:PBT,UL94V-0,GWT 750 °C
- 3.Finish:
(blank):Tin over Nickel
G:Gold over Nickel

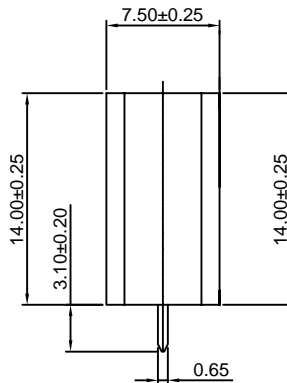
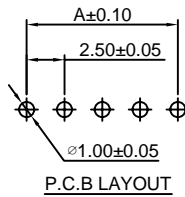
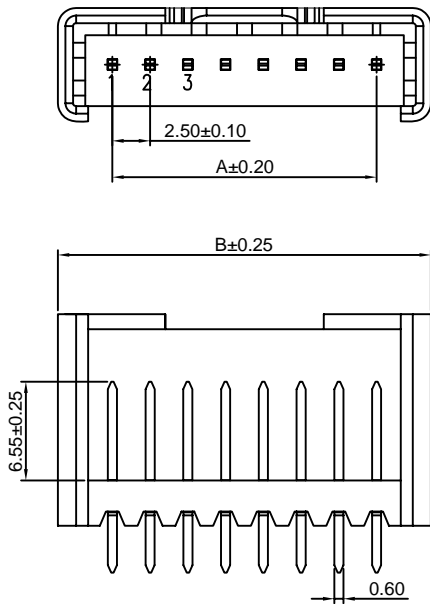

Ordering Information & Dimensions

PART NO.	Dimensions	
	A	B
2P	2.50	9.70
3P	5.00	12.20
4P	7.50	14.70
5P	10.00	17.20
6P	12.50	19.70
7P	15.00	22.20
8P	17.50	24.70
9P	20.00	27.20
10P	22.50	29.70
11P	25.00	32.20
12P	27.50	34.70
13P	30.00	37.20
14P	32.50	39.70
15P	35.00	42.20
16P	37.50	44.70
17P	40.00	47.20
18P	42.50	49.70
19P	45.00	52.20
20P	47.50	54.70

Unit: mm



A2502 SERIES

2.50mm pitch wire to board connector

A2502WRA-N-XP

2.50mm pitch 90° Wafer

Reference Informations:

- *Material:Pin:Brass/Tin over Nickel
Insulator:PBT+15%GF,UL94V-0
- *Mates with CJT A2502HWV-XP series Housing
- *Color:Gray

Ordering Information:
A2502WRA-N-XP - *** - **
1 2 3

- Part No.
- Material:
(Blank):PBT,UL94V-0
GWT:PBT,UL94V-0,GWT 750°C
- Finish:
(blank):Tin over Nickel
G:Gold over Nickel

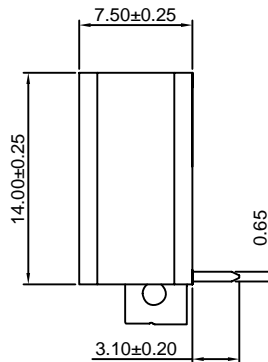
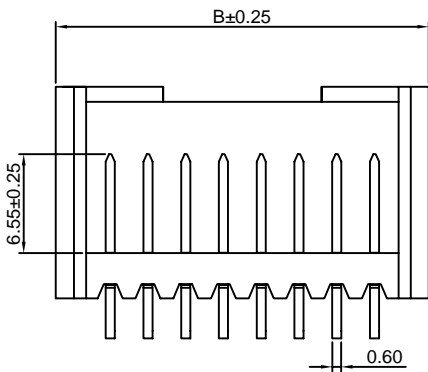
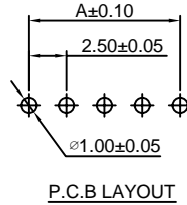
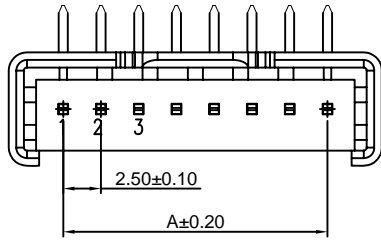

Ordering Information & Dimensions

PART NO.	Dimensions	
	A	B
2P	2.50	9.70
3P	5.00	12.20
4P	7.50	14.70
5P	10.00	17.20
6P	12.50	19.70
7P	15.00	22.20
8P	17.50	24.70
9P	20.00	27.20
10P	22.50	29.70
11P	25.00	32.20
12P	27.50	34.70
13P	30.00	37.20
14P	32.50	39.70
15P	35.00	42.20
16P	37.50	44.70
17P	40.00	47.20
18P	42.50	49.70
19P	45.00	52.20
20P	47.50	54.70

Unit: mm

A2502WVB-XP

2.50mm pitch 180° Wafer

Reference Informations:

- *Material:Pin:Brass/Tin over Nickel
Insulator:PBT+15%GF,UL94V-0
- *Mates with CJT A2502HWV-XP series Housing
- *Color:Gray

Ordering Information:
A2502WVB-XP - *** - *** - **
1 2 3 4

- Part No.
- Style:
(Blank):TYPE 1
2:TYPE 2
- Material:
(Blank):PBT,UL94V-0
GWT:PBT,UL94V-0,GWT 750°C
- Finish:
(blank):Tin over Nickel
G:Gold over Nickel

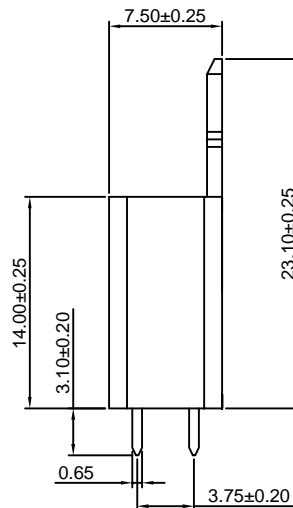
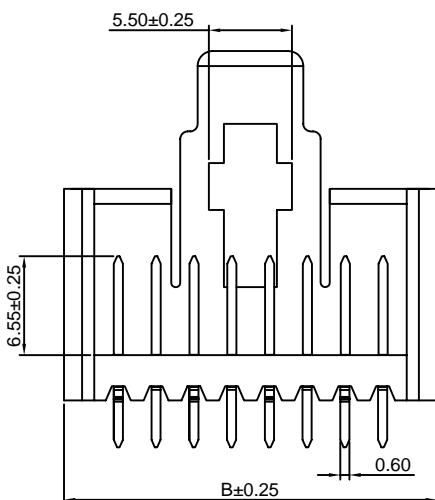
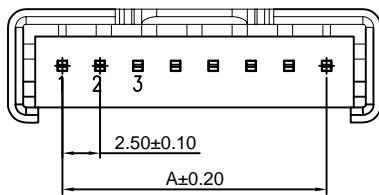
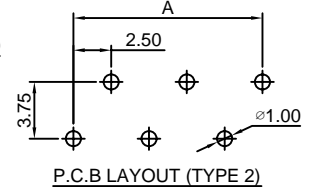
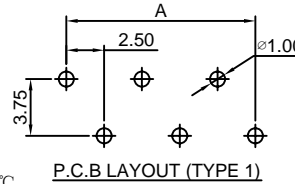

Ordering Information & Dimensions

PART NO.	Dimensions	
	A	B
2P	2.50	9.70
3P	5.00	12.20
4P	7.50	14.70
5P	10.00	17.20
6P	12.50	19.70
7P	15.00	22.20
8P	17.50	24.70
9P	20.00	27.20
10P	22.50	29.70
11P	25.00	32.20
12P	27.50	34.70
13P	30.00	37.20
14P	32.50	39.70
15P	35.00	42.20
16P	37.50	44.70
17P	40.00	47.20
18P	42.50	49.70
19P	45.00	52.20
20P	47.50	54.70

Unit: mm

A2502WRB-XP

2.50mm pitch 90° Wafer

Reference Informations:

- *Material: Pin: Brass/Tin over Nickel
Insulator: PBT+15%GF, UL94V-0
- *Mates with CJT A2502HWV-XP series Housing
- *Color: Gray

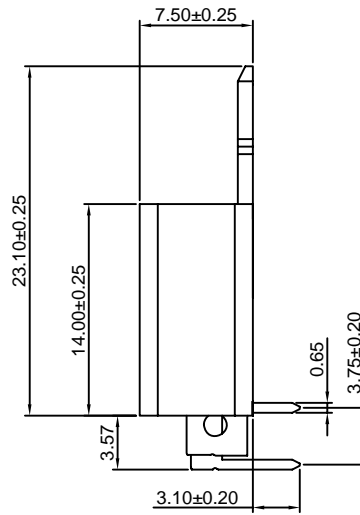
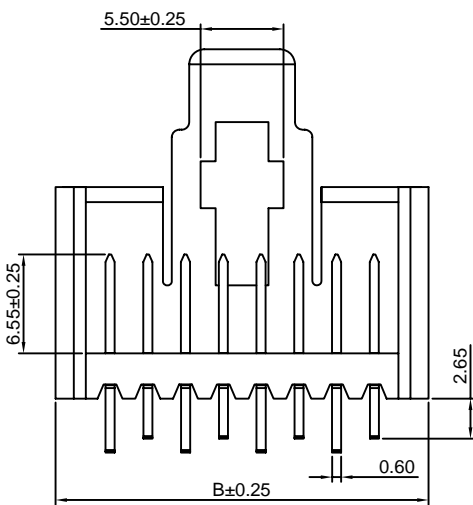
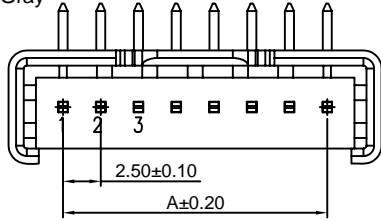

Ordering Information:
A2502WRB-XP - *** - *** - **
1 2 3 4

1. Part No.
2. Style:
(Blank): TYPE 1
2: TYPE 2
3. Material:
(Blank): PBT, UL94V-0
GWT: PBT, UL94V-0, GWT 750°C
4. Finish:
(blank): Tin over Nickel
G: Gold over Nickel

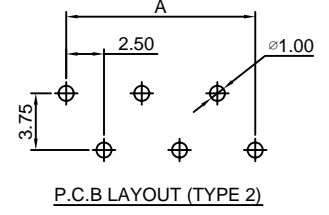
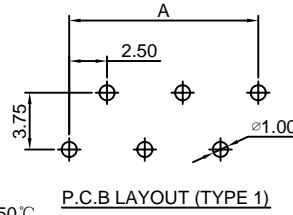

Ordering Information & Dimensions

PART NO.	Dimensions	
	A	B
2P	2.50	9.70
3P	5.00	12.20
4P	7.50	14.70
5P	10.00	17.20
6P	12.50	19.70
7P	15.00	22.20
8P	17.50	24.70
9P	20.00	27.20
10P	22.50	29.70
11P	25.00	32.20
12P	27.50	34.70
13P	30.00	37.20
14P	32.50	39.70
15P	35.00	42.20
16P	37.50	44.70
17P	40.00	47.20
18P	42.50	49.70
19P	45.00	52.20
20P	47.50	54.70

Unit: mm

A2502WVB-N-XP

2.50mm pitch 180° Wafer

Reference Informations:

- *Material: Pin: Brass/Tin over Nickel
Insulator: PBT+15%GF, UL94V-0
- *Mates with CJT A2502HWV-XP series Housing
- *Color: Gray

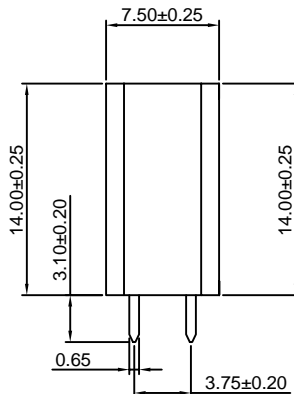
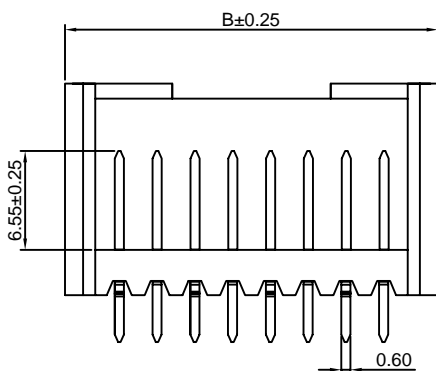
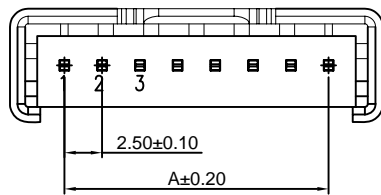

Ordering Information:
A2502WVB-N-XP - *** - *** - **
1 2 3 4

1. Part No.
2. Style:
(Blank): TYPE 1
2: TYPE 2
3. Material:
(Blank): PBT, UL94V-0
GWT: PBT, UL94V-0, GWT 750°C
4. Finish:
(blank): Tin over Nickel
G: Gold over Nickel

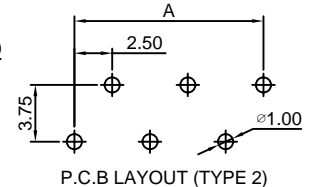
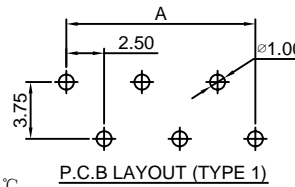

Ordering Information & Dimensions

PART NO.	Dimensions	
	A	B
2P	2.50	9.70
3P	5.00	12.20
4P	7.50	14.70
5P	10.00	17.20
6P	12.50	19.70
7P	15.00	22.20
8P	17.50	24.70
9P	20.00	27.20
10P	22.50	29.70
11P	25.00	32.20
12P	27.50	34.70
13P	30.00	37.20
14P	32.50	39.70
15P	35.00	42.20
16P	37.50	44.70
17P	40.00	47.20
18P	42.50	49.70
19P	45.00	52.20
20P	47.50	54.70

Unit: mm



A2502 SERIES

2.50mm pitch wire to board connector

A2502WRB-N-XP

2.50mm pitch 90° Wafer

Reference Informations:

- *Material: Pin: Brass/Tin over Nickel
Insulator: PBT +15%GF, UL94V-0
- *Mates with CJT A2502HWV-XP series Housing
- *Color: Gray

Ordering Information:
A2502WRB-N-XP - *** - *** - **
1 2 3 4

1. Part No.
2. Style:
(Blank): TYPE 1
2: TYPE 2
3. Material:
(Blank): PBT, UL94V-0
GWT: PBT, UL94V-0, GWT 750°C
4. Finish:
(blank): Tin over Nickel
G: Gold over Nickel

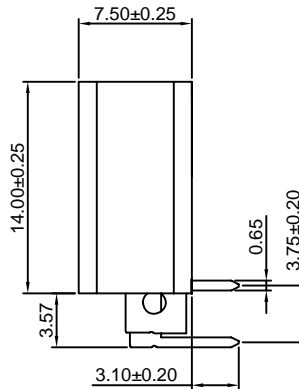
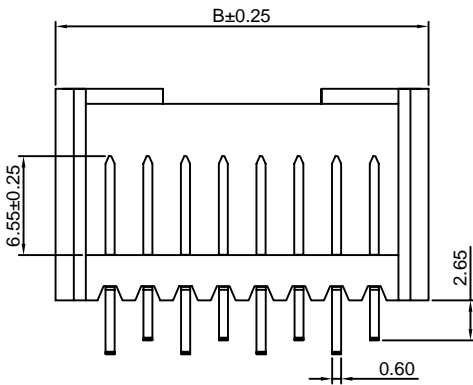
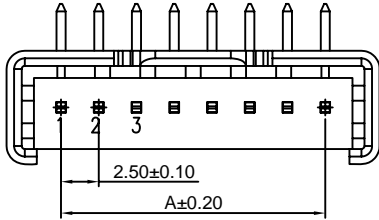
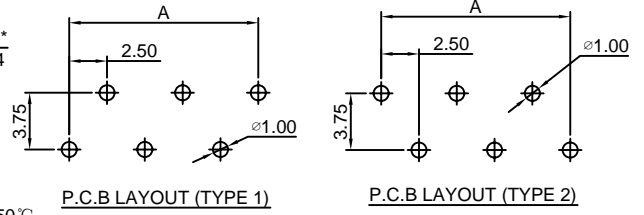

Ordering Information & Dimensions

PART NO.	Dimensions	
	A	B
2P	2.50	9.70
3P	5.00	12.20
4P	7.50	14.70
5P	10.00	17.20
6P	12.50	19.70
7P	15.00	22.20
8P	17.50	24.70
9P	20.00	27.20
10P	22.50	29.70
11P	25.00	32.20
12P	27.50	34.70
13P	30.00	37.20
14P	32.50	39.70
15P	35.00	42.20
16P	37.50	44.70
17P	40.00	47.20
18P	42.50	49.70
19P	45.00	52.20
20P	47.50	54.70

Unit: mm