

# 5F Series

Sub-Miniature Slide Switches

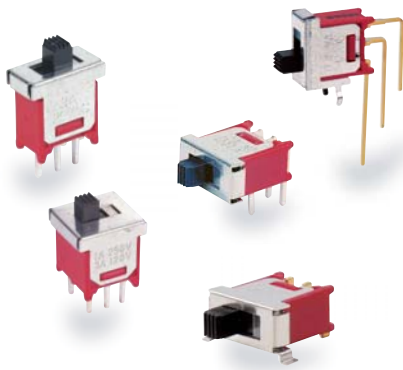

## SPECIFICATIONS

- CONTACT RATING:** Dependent upon contact material
- MECHANICAL LIFE:** 30,000 make-and-break cycles.
- CONTACT RESISTANCE:** 20 mΩ max. initial @ 2-4VDC  
100mA for both silver and gold plated contacts.
- INSULATION RESISTANCE:** 1,000 MΩ min.
- DIELECTRIC STRENGTH:** 1,000 Vrms min. @sea level.
- OPERATING TEMPERATURE:** -40°C to 85°C.(std)  
-30°C to 85°C.(SMT)

## MATERIALS

- CASE:** Diallyl phthalate (DAP) (UL94v-0).
- HOUSING:** Stainless steel or phosphor bronze, tin plated.
- ACTUATOR:** Nylon, black std.
- CONTACT:** Brass or copper alloy, with silver or gold plated.
- TERMINALS:** Copper alloy, with silver and gold plated.



## HOW TO ORDER

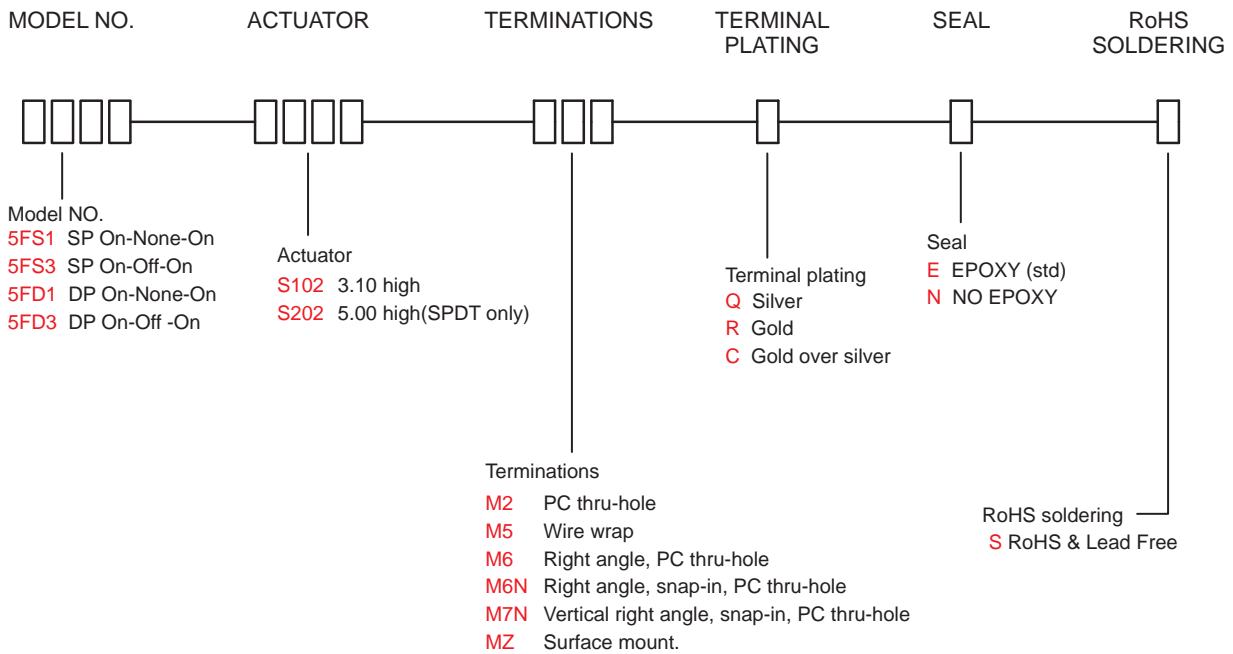

## SWITCH FUNCTION

NO. POLES	UL/CSA MODEL NO.	MODEL NO.	SWITCH FUNCTION			CONNECTED TERMINALS / SCHEMATIC		
			POS.1	POS.2	POS.3	POS.1	POS.2	POS.3
SP	Q2511	5FS1	ON	NONE	ON	2-1	N/A	2-3
	Q2513	5FS3	ON	OFF	ON	1-2 (COMM) 1-3	OPEN	1-2 (COMM) 1-3
DP	Q2521	5FD1	ON	NONE	ON	2-1,5-4	N/A	2-3,5-6
	Q2523	5FD3	ON	OFF	ON	1-2 (COMM) 5-6 1-3 4-6	OPEN	1-2 (COMM) 5-6 1-3 4-6

MOM=MOMENTARY

## POLE OPTIONS

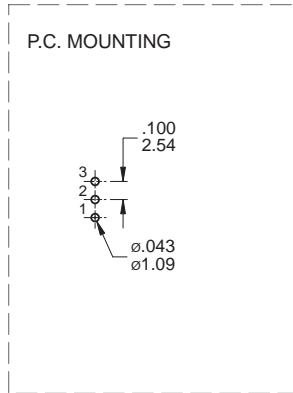
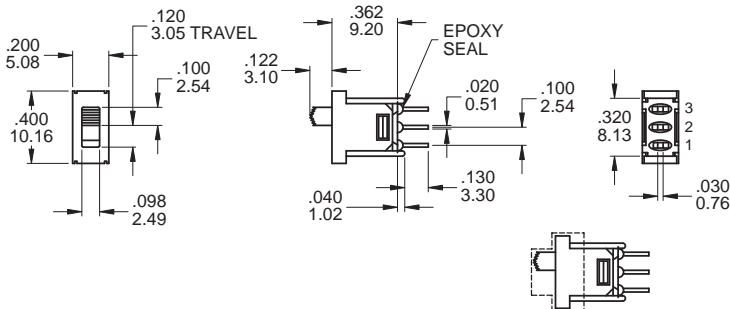

**SPDT**

Part No. Shown : 5FS1S102M2QES

Waterproof transparent cover

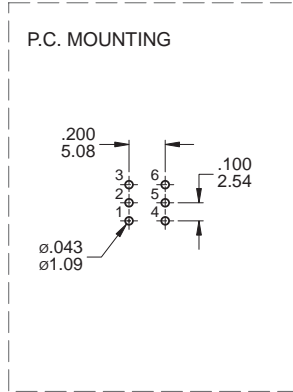
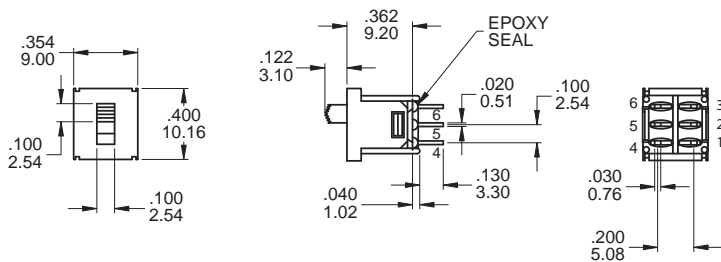

**DPDT**

Part No. Shown : 5FD1S102M2QES

## TERMINATION OPTIONS

**M2** PC Thru-hole

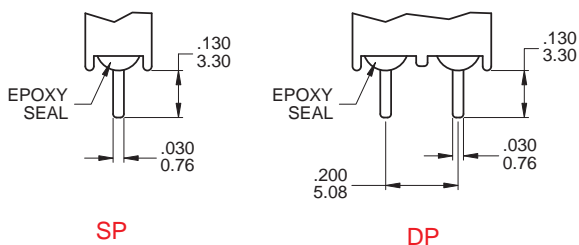

## OTHER TERMINATION OPTIONS

- M6** Right angle P.C. Mount
- M6N** Snap-in, Right angle P.C. Mount

# 5F Series

Sub-Miniature Slide Switches

M6

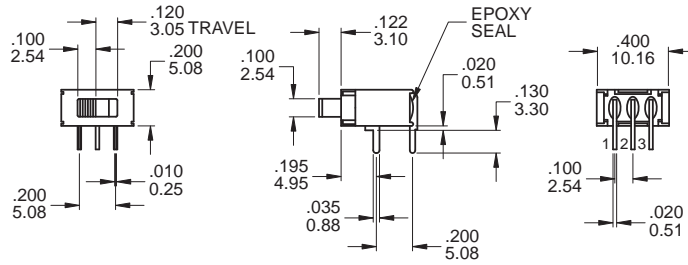
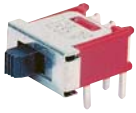

P.C. MOUNTING

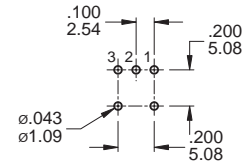

SPDT

Part No. Shown : 5FS1S102M6QES

M6

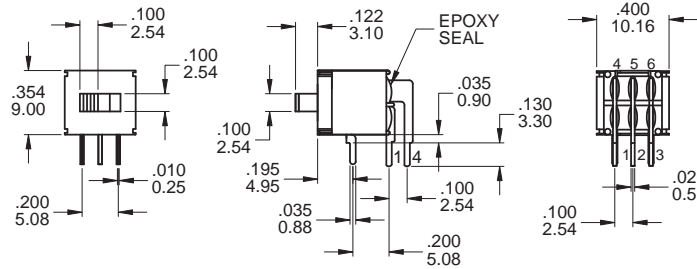
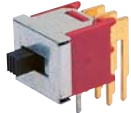

P.C. MOUNTING

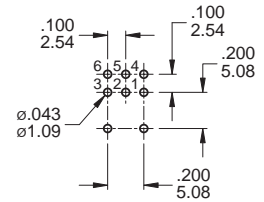

DPDT

Part No. Shown : 5FD1S102M6RES

MZ

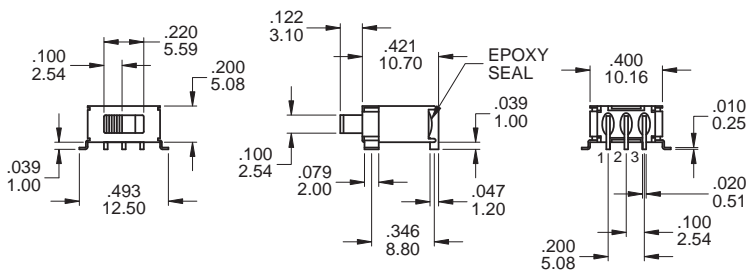

P.C. MOUNTING

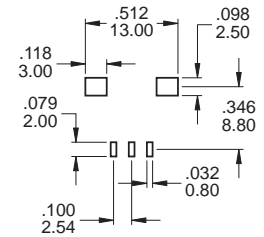

SPDT

Part No. Shown : 5FS1S102MZRES

M7N

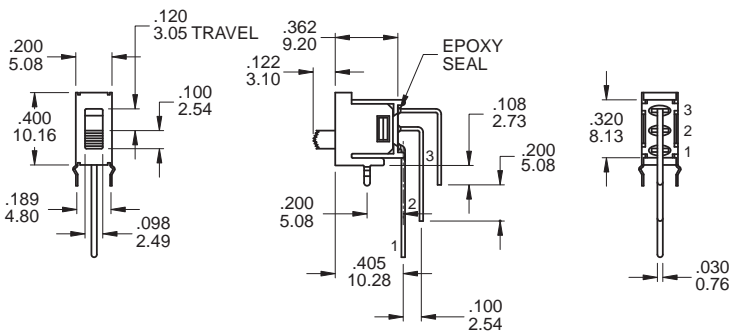

P.C. MOUNTING

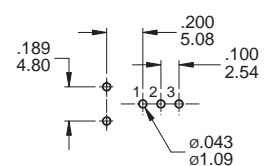

SPDT Only

Part No. Shown : 5FS1S102M7NRES

5F  
Slide Switches

## SNAP-IN TERMINATION OPTIONS

M6N

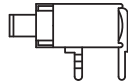

## CONTACT MATERIAL OPTIONS

	CONTACT PLATING	TERMINAL PLATING	RATINGS
<b>Q</b>	Silver	<b>Q</b> = Silver	3 Amps with resistant load @ 120VAC or 28VDC 1 Amps with resistant load @ 250VAC
<b>C</b>	Gold over Silver	<b>C</b> = Gold over silver	
<b>R</b>	Gold	<b>R</b> = Gold	0.4 Volt - Amps ( VA ) max. @ 20V max. ( AC or DC )

## SOLDERING PROCESSES

**MANUAL SOLDERING:** Use soldering iron of 30 watts, controlled at 350°C approximately 5 seconds while applying solder.

**WAVE SOLDERING:** Recommended Soldering Temperature: 270 ± 5°C

Duration of Solder Immersion: Max 5 sec. (PCB is 1.6mm in thickness)

