

ESD56171D04
1-Line, Bi-directional, Transient Voltage Suppressor
<http://www.sh-willsemi.com>
Descriptions

The ESD56171D04 is a bi-directional Transient Voltage Suppressor designed to protect power interfaces. It is suitable to replace multiple discrete components in portable electronics.

The ESD56171D04 may be used to provide ESD protection up to $\pm 30\text{kV}$ contact and air discharge according to IEC61000-4-2, and withstand peak pulse current up to 160A according to IEC61000-4-5 (8/20 μs).

The ESD56171D04 is available in DFN2.0 \times 2.0-3L package. Standard products are Pb-free and Halogen-free.

Features

- Reverse stand-off voltage: $\pm 4.5\text{V}$ max.
- ESD protection according to IEC61000-4-2
Contact & Air discharge: $\pm 30\text{kV}$
- Surge protection according to IEC61000-4-5
8/20 μs waveform: 160A
- Capacitance: $C_j = 400\text{pF}$ typ.
- Low clamping voltage
- Low leakage current
- Solid-state silicon technology

Applications

- Power supply protection
- Power management

Order information

| Device | Package | Shipping |
|------------------|------------------------|----------------|
| ESD56171D04-3/TR | DFN2.0 \times 2.0-3L | 3000/Tape&Reel |

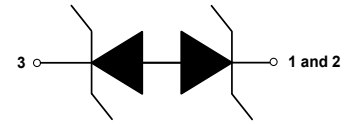
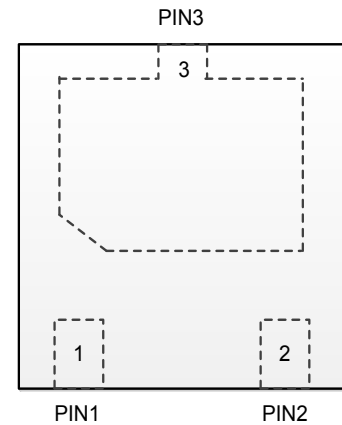
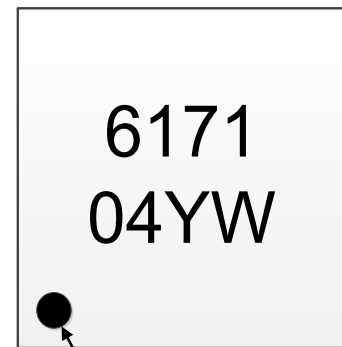

Circuit diagram

Pin configuration (Top View)

 Pin1
Indicator

6171 = Series code
04 = Device code
YW = Date code

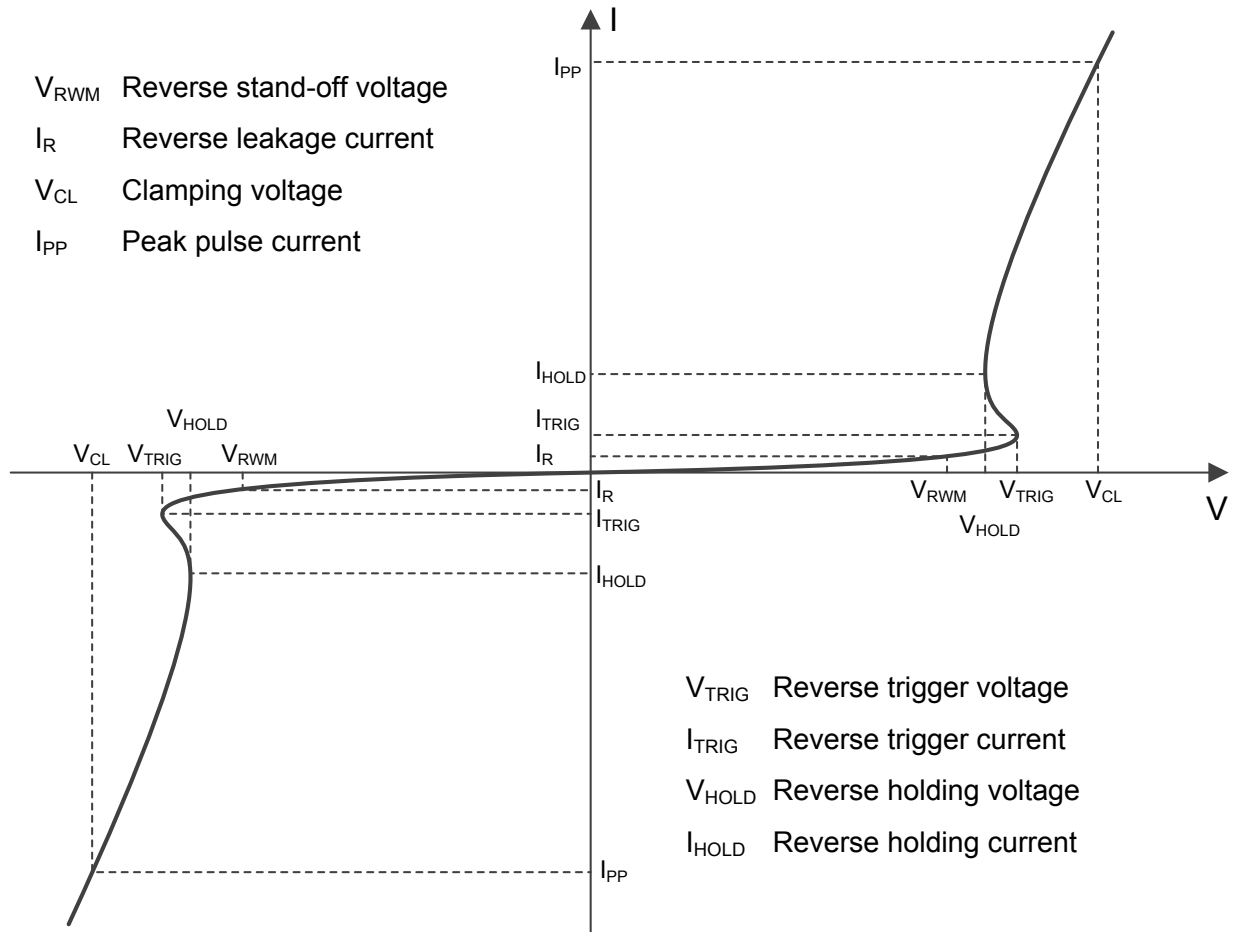
Marking

Absolute maximum ratings

| Parameter | Symbol | Rating | Unit |
|---|-----------|----------|-------------|
| Peak pulse power ($t_p = 8/20\mu s$) | P_{pk} | 2250 | W |
| Peak pulse current ($t_p = 8/20\mu s$) | I_{PP} | 160 | A |
| ESD according to IEC61000-4-2 air discharge | V_{ESD} | ± 30 | kV |
| ESD according to IEC61000-4-2 contact discharge | | ± 30 | |
| Junction temperature | T_J | 125 | $^{\circ}C$ |
| Operating temperature | T_{OP} | -40~85 | $^{\circ}C$ |
| Lead temperature | T_L | 260 | $^{\circ}C$ |
| Storage temperature | T_{STG} | -55~150 | $^{\circ}C$ |

Electrical characteristics ($T_A = 25^{\circ}C$, unless otherwise noted)

Definitions of electrical characteristics

Electrical characteristics ($T_A = 25^\circ\text{C}$, unless otherwise noted)

| Parameter | Symbol | Condition | Min. | Typ. | Max. | Unit |
|----------------------------------|------------|--|------|------|-----------|---------------|
| Reverse stand-off voltage | V_{RWM} | | | | ± 4.5 | V |
| Reverse leakage current | I_R | $V_{RWM} = 4.5\text{V}$ | | | 1 | μA |
| Reverse trigger voltage | V_{TRIG} | $I_{TRIG} = 2\mu\text{A}$ | 4.7 | | | V |
| Reverse holding voltage | V_{HOLD} | $I_{HOLD} = 50\text{mA}$ | 4.6 | | | V |
| Clamping voltage ¹⁾ | V_{CL} | $V_{ESD} = 8\text{kV}$ | | 7 | | V |
| Clamping voltage ²⁾ | V_{CL} | $I_{PP} = 16\text{A}$, $t_p = 100\text{ns}$ | | 6 | | V |
| Dynamic resistance ²⁾ | R_{DYN} | | | 0.05 | | Ω |
| Clamping voltage ³⁾ | V_{CL} | $I_{PP} = 1\text{A}$, $t_p = 8/20\mu\text{s}$ | | | 6 | V |
| | | $I_{PP} = 100\text{A}$, $t_p = 8/20\mu\text{s}$ | | | 11 | V |
| | | $I_{PP} = 160\text{A}$, $t_p = 8/20\mu\text{s}$ | | | 14 | V |
| Junction capacitance | C_J | $V_R = 0\text{V}$, $f = 1\text{MHz}$, | | 400 | 600 | pF |
| | | $V_R = 4.5\text{V}$, $f = 1\text{MHz}$ | | 270 | 360 | pF |

Notes:

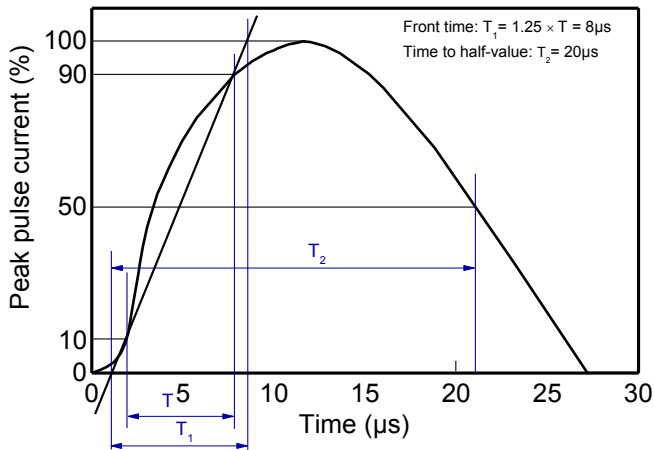
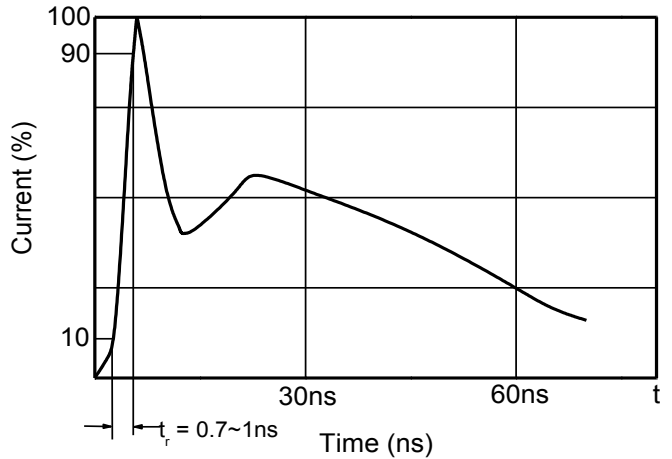
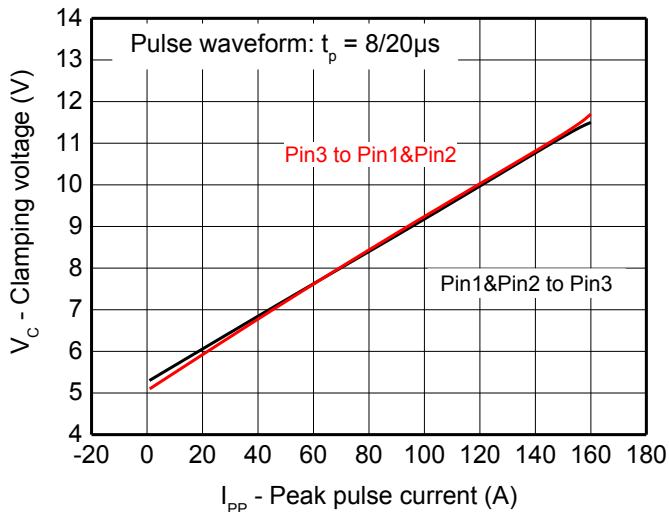
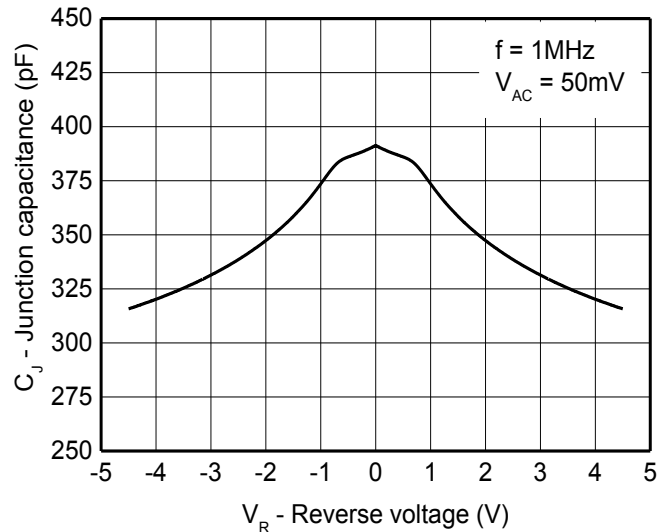
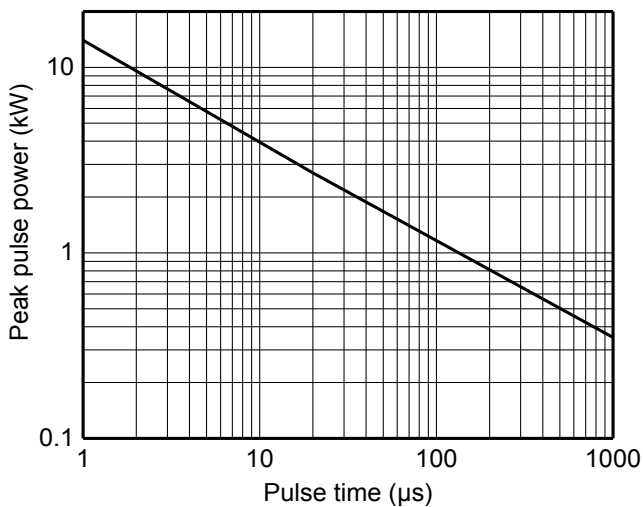
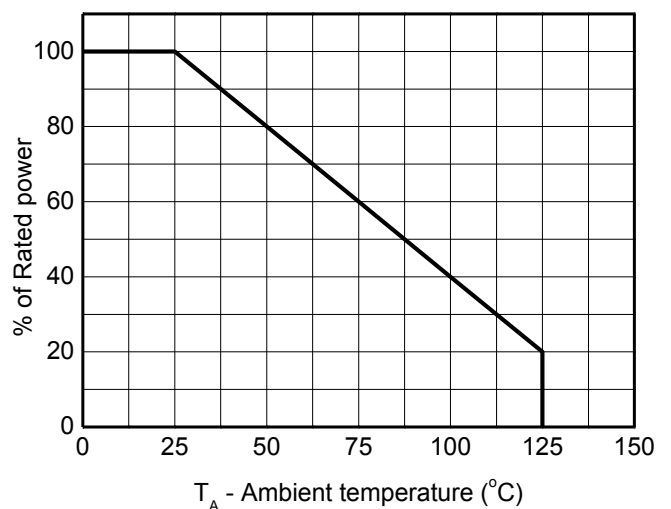
- 1) Contact discharge mode, according to IEC61000-4-2.
- 2) TLP parameter: $Z_0 = 50\Omega$, $t_p = 100\text{ns}$, $t_r = 2\text{ns}$, averaging window from 60ns to 80ns. R_{DYN} is calculated from 4A to 16A.
- 3) Non-repetitive current pulse, according to IEC61000-4-5.

Typical characteristics ($T_A = 25^\circ\text{C}$, unless otherwise noted)

8/20 μs waveform per IEC61000-4-5

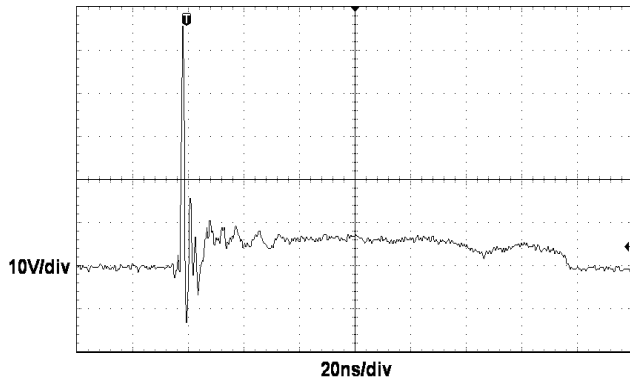
Contact discharge current waveform per IEC61000-4-2

Clamping voltage vs. Peak pulse current

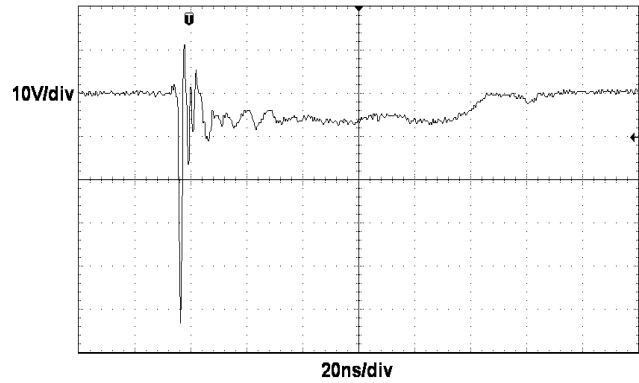
Capacitance vs. Reverse voltage

Non-repetitive peak pulse power vs. Pulse time

Power derating vs. Ambient temperature

Typical characteristics ($T_A=25^{\circ}\text{C}$, unless otherwise noted)



ESD clamping
 (+8kV contact discharge per IEC61000-4-2)



ESD clamping
 (-8kV contact discharge per IEC61000-4-2)

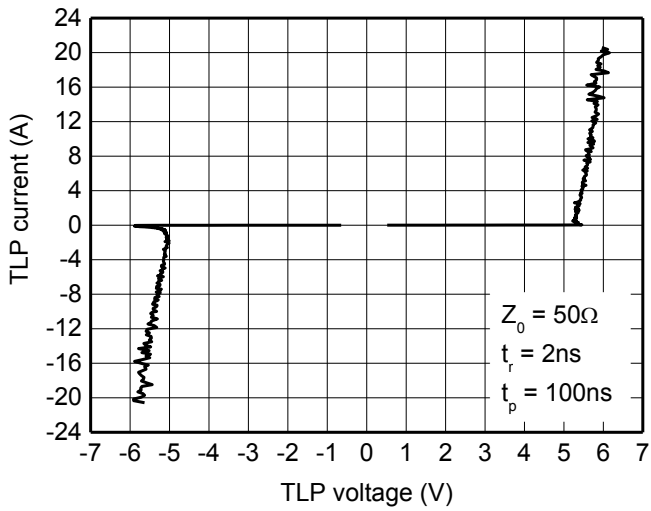

TLP Measurement

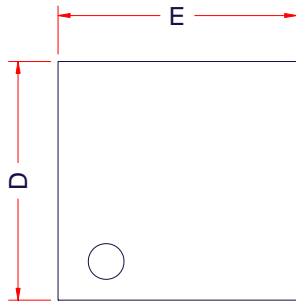
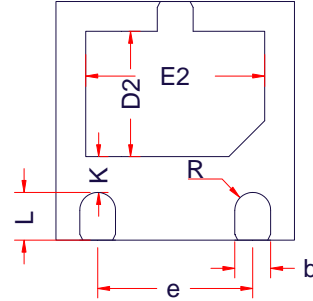
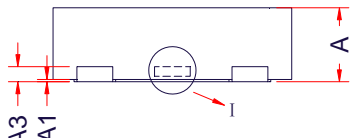
PACKAGE OUTLINE DIMENSIONS
DFN2x2-3L

TOP VIEW

BOTTOM VIEW

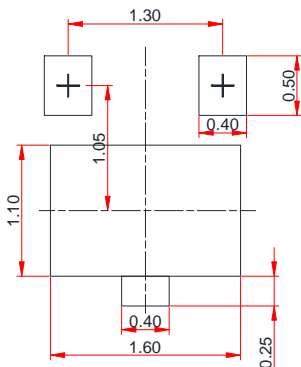
SIDE VIEW

- I
1. 
 2. (N/A)

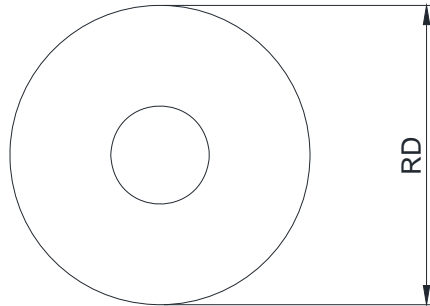
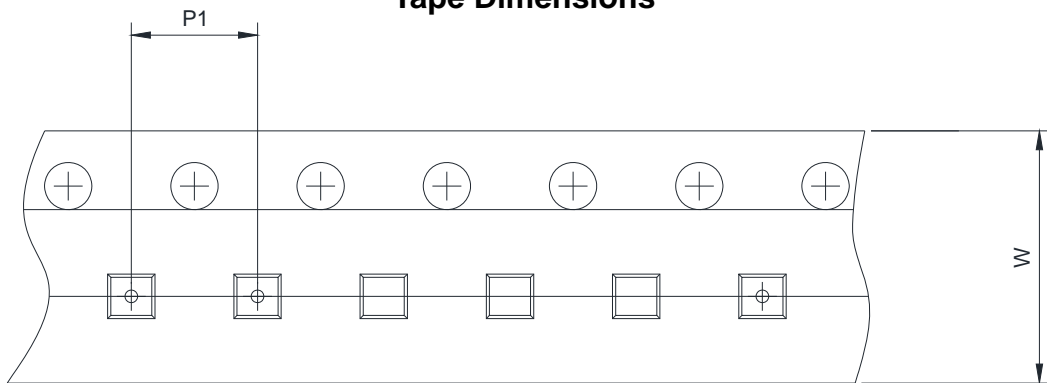
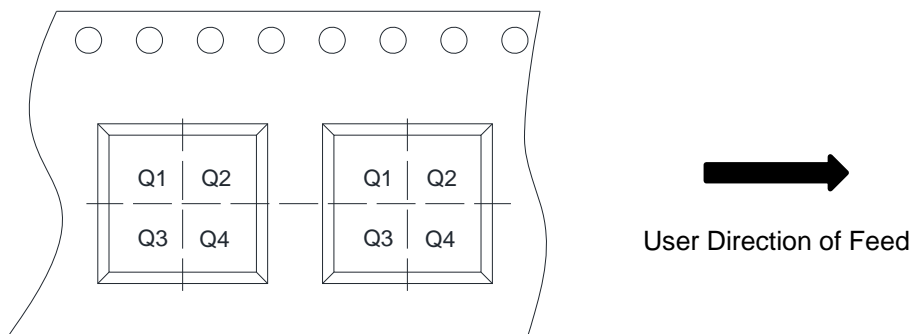
| Symbol | Dimensions in Millimeters | | |
|--------|---------------------------|------|------|
| | Min. | Typ. | Max. |
| A | 0.50 | 0.58 | 0.65 |
| A1 | 0.00 | 0.02 | 0.05 |
| A3 | 0.127Ref. | | |
| b | 0.25 | 0.30 | 0.35 |
| D | 1.90 | 2.00 | 2.10 |
| E | 1.90 | 2.00 | 2.10 |
| D2 | 0.95 | 1.05 | 1.15 |
| E2 | 1.40 | 1.50 | 1.60 |
| e | 1.20 | 1.30 | 1.40 |
| R | 0.13 | - | - |
| L | 0.33 | 0.39 | 0.45 |
| K | 0.20 | - | - |

Recommend PCB Layout (Unit: mm)

Notes:

This recommended land pattern is for reference purposes only. Please consult your manufacturing group to ensure your PCB design guidelines are met.

TAPE AND REEL INFORMATION
Reel Dimensions

Tape Dimensions

Quadrant Assignments For PIN1 Orientation In Tape

| | | | | | |
|------|---|---|---|------------------------------|-----------------------------|
| RD | Reel Dimension | <input checked="" type="checkbox"/> 7inch | <input type="checkbox"/> 13inch | | |
| W | Overall width of the carrier tape | <input checked="" type="checkbox"/> 8mm | <input type="checkbox"/> 12mm | | |
| P1 | Pitch between successive cavity centers | <input type="checkbox"/> 2mm | <input checked="" type="checkbox"/> 4mm | <input type="checkbox"/> 8mm | |
| Pin1 | Pin1 Quadrant | <input type="checkbox"/> Q1 | <input checked="" type="checkbox"/> Q2 | <input type="checkbox"/> Q3 | <input type="checkbox"/> Q4 |