

**描述 / Descriptions**

BRCL3230BZF 产品是单节锂离子/锂聚合物可充电电池组保护的高集成度解决方案。BRCL3230BZF 包括了先进的功率 MOSFET，高精度的电压检测电路和延时电路。

BRCL3230BZF 具有非常小的 DFN2\*2-6L 的封装，这使得该器件非常适合应用于空间限制得非常小的可充电电池组应用。BRCL3230BZF 具有过充，过放，过流，短路等所有的电池所需要保护功能，并且工作时功耗非常低。该芯片不仅仅为手机而设计，也适用于一切需要锂离子或锂聚合物可充电电池长时间供电的各种信息产品的应用场合。

The BRCL3230BZF series product is a high integration solution for lithium-ion/polymer battery protection. BRCL3230BZF contains advanced power MOSFET, high-accuracy voltage detection circuits and delay circuits.

BRCL3230BZF is put into an ultra-small DFN2\*2-6L package makes it an ideal solution in limited space of battery pack. BRCL3230BZF has all the protection functions required in the battery application including overcharging, overdischarging, overcurrent and load short circuiting protection etc. The low standby current drains little current from the cell while in storage. The device is not only targeted for digital cellular phones, but also for any other Li-Ion and Li-Poly battery-powered information appliances requiring long-term battery life.

**特征 / Features**

- ◆ 内部集成等效 25mΩ 的先进的功率 MOSFET；
- ◆ 超小封装 DFN2\*2-6L；
- ◆ 内部集成 RC，无需任何外围器件；
- ◆ 过温保护；
- ◆ 过充电电流保护；
- ◆ 2 段过流保护：过放电电流 1，过放电电流 2，负载短路电流；
- ◆ 充电器检测；
- ◆ 0V 电池充电功能，延迟时间内部设定，高精度电压检测；
- ◆ 低静态电流，正常工作电流：3.0uA, 待机电流：1.7uA；
- ◆ 无卤产品
- ◆ Integrate advanced power MOSFET with Equivalent of 25mΩ  $R_{DS(ON)}$ ;
- ◆ Ultra-small DFN2\*2-6L package;
- ◆ Internal integration RC without any peripheral devices;
- ◆ Over-temperature Protection;
- ◆ Overcharge Current Protection;
- ◆ Three-step Overcurrent Detection: Overdischarge Current1, Overdischarge Current2, Load Short Circuiting;
- ◆ Charger detection function;
- ◆ 0V battery charging function, delay times are generated inside, High-accuracy voltage detection.
- ◆ Low Current Consumption, Operation Mode: 3.0μA typ, Power-down Mode: 1.7μA typ ;
- ◆ HF Product;

**用途 / Applications**

单芯锂离子电池组；锂聚合物电池组。

One-Cell lithium-ion battery pack; Lithium-Polymer battery pack.

**典型应用电路图 / Typical Application**

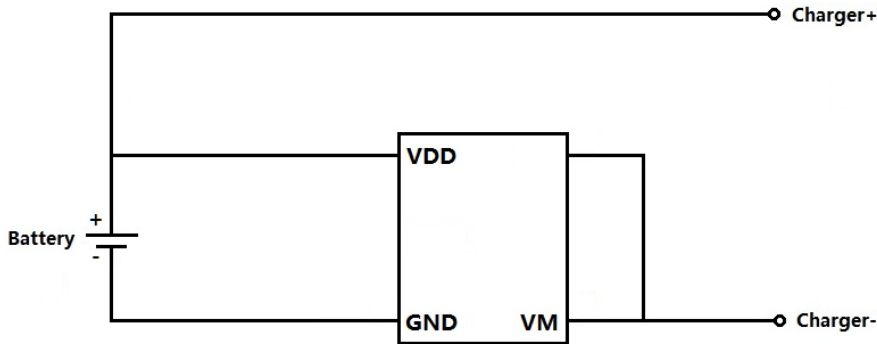

注意：

- (1) 芯片功耗不得超过封装所承受的最大功耗。
- (2) 本产品具有防静电保护功能，但不要超过产品最大的承受静电能力。

Notes:

- (1) The chip power consumption shall not exceed the maximum power consumed by the package.
- (2) This product has anti-static protection function, but do not exceed the maximum capacity of the product to withstand static electricity.

**引脚排列 / Pinning**

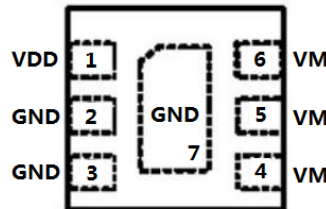
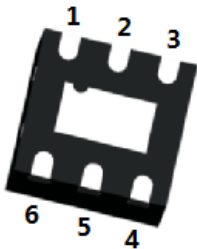

引脚编号 Pin Number	引脚名称 Pin Name	引脚说明 Pin Description
1	VDD	Power Supply
2、3、7	GND	Ground, connect the negative terminal of the battery to this pin.
4、5、6	VM	The negative terminal of the charger. The internal FET switch connects this terminal to GND.

**印章代码 / Marking**

见印章说明。 See Marking Instructions.

**极限参数 / Absolute Maximum Ratings(Ta=25°C)**

参数/Parameter	符号/Symbol	数值/Value	单位/Unit
V <sub>DD</sub> input pin voltage	V <sub>IN</sub>	-0.3 to +6	V
V <sub>M</sub> input pin voltage	V <sub>VM</sub>	-6 to +10	V
Power Dissipation	P <sub>D</sub>	400	mW
Maximum Junction Temperature	T <sub>J</sub>	125	°C
Lead Temperature	T <sub>L</sub>	300	°C
Operating Junction Temperature	T <sub>opr</sub>	-40 to +85	°C
Storage Temperature	T <sub>stg</sub>	-55 to +150	°C
Package Thermal Resistance	R <sub>θJA</sub>	250	°C/W
	R <sub>θJc</sub>	130	°C/W
ESD	ESD	2000	V

**电性能参数 / Electrical Characteristics( 除非特别指定 , Ta=25°C)**

参数/Parameter	符号 /Symbol	测试条件/Test Condition	最小值 /Min	典型值 /Typ	最大值 /Max	单位 /Unit
<b>Detection voltage</b>						
Overcharge Detection Voltage	V <sub>CU</sub>		4.25	4.30	4.35	V
Overcharge Release Voltage	V <sub>CL</sub>		4.05	4.10	4.15	V
Overdischarge Detection Voltage	V <sub>DL</sub>		2.30	2.40	2.50	V
Overdischarge Release Voltage	V <sub>DR</sub>		2.90	3.00	3.10	V
Charger Detection Voltage	V <sub>CHA</sub>		-0.3	-0.4	-0.5	V
<b>Detection current</b>						
Overcharge Current Detection	I <sub>IOCC</sub>	V <sub>dd</sub> =3.6V	4.5	5.5	6.5	A
Overdischarge Current1 Detection	I <sub>IOV1</sub>	V <sub>dd</sub> =3.6V	4	5	6	A
Overdischarge Current2 Detection	I <sub>IOV2</sub>	V <sub>dd</sub> =3.6V	7	9.5	11	A
Load Short-Circuiting Detection	I <sub>SHORT</sub>	V <sub>dd</sub> =3.6V	12	18	25	A
<b>Static current</b>						
Current Consumption in Normal Operation	I <sub>OPE</sub>	V <sub>dd</sub> =3.6V, V <sub>M</sub> =0V	1.5	3.0	6.0	μA
Current Consumption in power Down	I <sub>PDN</sub>	V <sub>dd</sub> =2V, V <sub>M</sub> floating	1	1.7	2.5	μA

电性能参数 / Electrical Characteristics( 除非特别指定, Ta=25°C)

Equivalent FET on Resistance						
Equivalent FET on Resistance	R <sub>DS</sub>	V <sub>dd</sub> =3.6V, I <sub>VM</sub> =1A	15	25	40	mΩ
Over temperature protection						
Over Temperature Protection	OTP		125	140	155	°C
Over Temperature Recovery Degree	OTPR		100	115	130	°C
Delay time						
Overcharge Current Detection Delay Time	T <sub>OCC</sub>	V <sub>dd</sub> =3.6V	5.6	8	10.4	ms
Overcharge Voltage Detection Delay Time	T <sub>CU</sub>	V <sub>DD</sub> =3.6V~4.4V	95	135	175	ms
Overdischarge Voltage Detection Delay Time	T <sub>DL</sub>	V <sub>DD</sub> =3.6V~2.0V	25	35	45	ms
Overdischarge Current1 Detection Delay Time	T <sub>IOV1</sub>	V <sub>DD</sub> =3.6V	5.6	8	10.4	ms
Overdischarge Current2 Detection Delay Time	T <sub>IOV2</sub>	V <sub>DD</sub> =3.6V	0.7	1	1.3	ms
Load Short-Circuiting Detection Delay Time	T <sub>SHORT</sub>	V <sub>DD</sub> =3.6V		100	300	us

功能框图 / Functionl Block Diagram

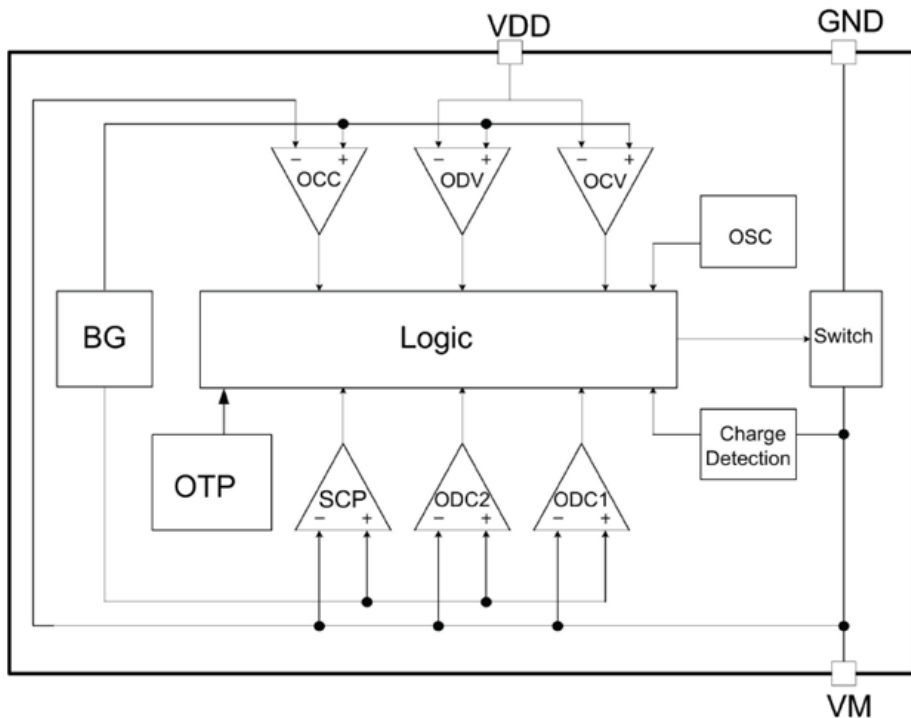

### 功能描述 / Functional Description

BRCL3230BZF监控电池的电压和电流，并通过断开充电器或负载，保护单节可充电锂电池不会因为过充电电压，过放电压，过充电流，过放电流以及短路等情况而损坏。系统外围电路简单。MOSFET已内置，等效电阻典型值为25mΩ。

The BRCL3230BZF monitors the voltage and current of a battery and protects it from being damaged due to overcharge voltage, overdischarge voltage, overdischarge current, and short circuit conditions by disconnecting the battery from the load or charger. The peripheral circuit is very simple. The MOSFET is integrated and its  $R_{DS(ON)}$  is as low as 25mΩ typical.

### 正常工作模式 / Normal Operating mode

如果没有检测到任何异常情况，输出管一直打开，充电和放电过程都将自由转换。这种情况称为正常工作模式。

If no exception condition is detected, charging and discharging can be carried out freely. This condition is called the normal operating mode.

### 过充电情况 / Overcharge Condition

在正常条件下的充电过程中，当电池电压高于过充检测电压（VCU），并持续时间达到过充电电压检测延迟时间（TCU）或更长，BRCL3230BZF将关断FET以停止充电。这种情况称为过充电电压情况。

以下两种情况下，过充电电压情况将被释放：

- （1）当电池电压低于过充解除电压（VCL），BRCL3230BZF打开输出管，回到正常工作模式。
- （2）当连接一个负载进行放电，BRCL3230BZF打开输出管，回到正常工作模式。解除机制如下：接上负载后放电电流立刻流过输出管的内部寄生二极管，VM电压升到0.7V（即二极管的正向压降），BRCL3230BZF检测到这个电压后，将过充电电压阈值切换到VCU，接下来，当电池电压低于过充检测电压（VCU），BRCL3230BZF立刻恢复到正常工作模式，但是如果电池电压高于过充检测电压（VCU），即使负载是接着的，芯片也不会恢复到正常工作模式，必须要等到电池电压低于过充检测电压（VCU）。另外，在接上负载放电时，如果VM电压等于或低于过电流1检测电压，芯片不会恢复到正常工作模式。

注：当电池被充电到超过过充检测电压（VCU）并且电池电压没有降到过充检测电压（VCU）以下，即使加上一个可以导致过流的重载，过流1和过流2都不会工作，除非电池电压跌倒过充检测（VCU）以下。但是实际上电池是有内阻的，当电池接上一个重载，电池的电压会立即跌落，这时过流1和过流2就会动作。

When the battery voltage becomes higher than the overcharge detection voltage (VCU) during charging under normal condition and the state continues for the overcharge detection delay time (TCU) or longer, the BRCL3230BZF turns the charging control FET off to stop charging. This condition is called the overcharge condition.

The overcharge condition is released in the following two cases:

- （1）When the battery voltage drops below the overcharge release voltage (VCL), the BRCL3230BZF turns the charging control FET on and returns to the normal condition.
- （2）When a load is connected and discharging starts, the BRCL3230BZF turns the charging control FET on and returns to the normal condition. The release mechanism is as follows: the discharging current flows through an internal parasitic diode of the charging FET immediately after a load is connected and discharging starts, and the VM pin voltage increases about 0.7 V (forward voltage of the diode) from the GND pin voltage momentarily.

**过充电电压情况 / Overcharge Condition**

The BRCL3230BZF detects this voltage and releases the overcharge condition. Consequently, in the case that the battery voltage is equal to or lower than the overcharge detection voltage (VCU), the BRCL3230BZF returns to the normal condition immediately, but in the case the battery voltage is higher than the overcharge detection voltage (VCU), the chip does not return to the normal condition until the battery voltage drops below the overcharge detection voltage (VCU) even if the load is connected. In addition, if the VM pin voltage is equal to or lower than the overcurrent 1 detection voltage when a load is connected and discharging starts, the chip does not return to the normal condition.

Note: If the battery is charged to a voltage higher than the overcharge detection voltage (VCU) and the battery voltage does not drop below the overcharge detection voltage (VCU) even when a heavy load, which causes an overcurrent, is connected, the overcurrent 1 and overcurrent 2 do not work until the battery voltage drops below the overcharge detection voltage (VCU). Since an actual battery has, however, an internal impedance of several dozens of mΩ, and the battery voltage drops immediately after a heavy load which causes an overcurrent is connected, the overcurrent 1 and overcurrent 2 work. Detection of load shortcircuiting works regardless of the battery voltage.

**过放电压情况 / Overdischarge Condition**

在正常放电过程中，当电池电压降到过放检测电压（VDL）以下，并且持续时间达到过放电压检测延时时间（TDL）或更长，BRCL3230BZF将切断电池和负载的连接，停止放电。这种情况被称为过放电压情况。当控制放电的FET被关断，VM通过内部VM与VDD之间的RVMD电阻被拉到高电平，同时芯片的耗电电流会降到休眠电流（IPDN），这种情况被称为休眠情况。在过放和休眠情况中，VM和VDD之间由RVMD电阻连接。当一个充电器连接上并且VM电压低于充电检测电压（VCHA）时，休眠状态解除。这时放电FET仍然是断开的。当电池电压升高到过放检测电压（VDL）或更高时（见备注），BRCL3230BZF打开FET进入正常工作模式。

备注：在电池处于过放电情况下接上充电器，如果VM端电压不低于充电检测电压（VCHA），并且电池电压达到过放解除电压（VDR）或更高，过放情况解除。

When the battery voltage drops below the overdischarge detection voltage (VDL) during discharging under normal condition and it continues for the overdischarge detection delay time (tDL) or longer, the BRCL3230BZF turns the discharging control FET off and stops discharging. This condition is called overdischarge condition. After the discharging control FET is turned off, the VM pin is pulled up by the RVMD resistor between VM and VDD in BRCL3230BZF, the current of the chip is reduced to the power-down current (IPDN). This condition is called power-down condition. The VM and VDD pins are shorted by the RVMD resistor. The power-down condition is released when a charger is connected and the potential difference between VM and VDD becomes typical or higher, at this time, the FET is still off. When the battery voltage becomes the overdischarge detection voltage (VDL) or higher (see note), the BRCL3230BZF turns the FET on and changes to the normal condition from the overdischarge condition.

Note: If the VM pin voltage is no less than the charger detection voltage (VCHA), when the battery under overdischarge condition is connected to a charger, the overdischarge condition is released (the discharging control FET is turned on) as usual, provided that the battery voltage reaches the overdischarge release voltage (VDR) or higher.

**过放电流情况 / Overcurrent Condition**

正常工作模式下，当放电电流等于或高于设定的值（VM电压等于或高于过电流检测电压），并且持续时间达到过放电流检测延迟时间，BRCL3230BZF关断放电FET，停止放电。这种情况称为过放电流情况（包括过放电流1，过放电流2和负载短路电流）。过放电流情况下，VM和GND被RVMS电阻给短接了。当一个负载连接上，VM电压等于VDD减去负载电阻上的电压。

由于VM和GND之间连接 RVMS电阻，当负载断开，VM电压被拉到地电位。当检测到VM电位低于过流1检测电压，芯片回到正常状态。

When the discharging current becomes equal to or higher than a specified value (the VM pin voltage is equal to or higher than the overcurrent detection voltage) during discharging under normal condition and the state continues for the overcurrent detection delay time or longer, the BRCL3230BZF turns off the discharging control FET to stop discharging. This condition is called overcurrent condition. (The overcurrent includes overcurrent, or load shortcircuiting.) The VM and GND pins are shorted internally by the RVMS resistor under the overcurrent condition. When a load is connected, the VM pin voltage equals the VDD voltage due to the load.

Because of the connection between the VM and the GND by the RVMS resistor, when the load is removed, the VM pin goes back to the GND potential since the VM pin is shorted the GND pin with the RVMS resistor. Detecting that the VM pin potential is lower than the overcurrent detection voltage (VIOV1), the IC returns to the normal condition.

**异常充电电流检测 / Abnormal Charge Current Detection**

正常充电时，如果VM电压降到充电检测电压以下(VCHA)，并且持续时间超过过充电检测延时时间(TCU)，BRCL3230BZF关断充电FET停止充电。这种情况称为异常充电电流检测。

断开充电器，VM和GND之间电压高于充电器检测电压(VCHA)时，异常充电电流模式解除。由于0V电池充电功能优先级高于不正常电流充电检测，电池电压很低的电池正在进行0V充电时，异常充电电流检测将不工作。

If the VM pin voltage drops below the charger detection voltage (VCHA) during charging under the normal condition and it continues for the overcharge detection delay time (TCU) or longer, the BRCL3230BZF turns the charging control FET off and stops charging. This action is called abnormal charge current detection.

Abnormal charge current detection is released when the voltage difference between VM pin and GND pin becomes higher than the charger detection voltage (VCHA) by separating the charger. Since the 0 V battery charging function has higher priority than the abnormal charge current detection function, abnormal charge current may not be detected by the product with the 0 V battery charging function while the battery voltage is low.

**负载短路情况 / Load Short-circuiting Condition**

如果VM电压高于短路保护电压（VSHORT），并且持续时间超过短路检测延迟时间（tSHORT），BRCL3230BZF将与负载断开停止放电。当VM电压低于短路保护电压（VSHORT）时，例如负载被移除，负载短路情况将解除。

If voltage of VM pin is higher short circuiting protection voltage (VSHORT) and it continues for the tSHORT or longer, the BRCL3230BZF will stop discharging and battery is disconnected from load. This status is released when voltage of VM pin is higher than short protection voltage (VSHORT), such as when disconnecting the load.

**0V 电池充电功能 / 0V Battery Charging Function**

此功能用于对已经自放电到 0V 的电池进行再充电。当充电器插上时，会通过内部二极管来给电池进行充电，当电池电压高于过放电检测电压（VDL）时，保护IC进入正常工作状态。

注：(1)某些完全自放电后的电池，不允许被再次充电，这是由锂电池的特性决定的。请问电池供应商，确认所购买的电池是否具备“允许向 0V 电池充电”的功能，还是“禁止向 0V 电池充电”的功能。

(2)“允许向 0V 电池充电功能”比“充电过流检测功能”优先级更高。因此，使用“允许向 0V 电池充电”功能的 IC，在电池电压较低的时候会强制充电。电池电压低于过放电检测电压（VDL）以下时，不能进行充电过流状态的检测。

(3)当电池第一次接上保护电路时，这个电路可能不会进入正常模式，此时无法放电。如果产生这种现象，使 VM 管脚电压等于 GND 电压（将 VM 与 GND 短路或连接充电器），就可以进入正常模式。

This function enables the charging of a connected battery whose voltage is 0V by self-discharge. When connects to a charger, the discharging control FET is off and the charging current flows through the internal parasitic diode in the discharging control FET. If the battery voltage becomes equal to or higher than the overdischarge release voltage (VDL), the normal condition returns.

Notes :

(1) Some battery providers do not recommend charging of completely discharged batteries. Please refer to battery providers before the selection of 0 V battery charging function.

(2) The 0V battery charging function has higher priority than the abnormal charge current detection function. Consequently, a product with the 0 V battery charging function charges a battery and abnormal charge current cannot be detected during the battery voltage is low.

(3) When a battery is connected to the IC for the first time, the IC may not enter the normal condition in which discharging is possible. In this case, set the VM pin voltage equal to the GND voltage (short the VM and GND pins or connect a charger) to enter the normal condition.



时序图 / Timing Chart

过充和过放电电压检测/Overcharge And Overdischarge Detection

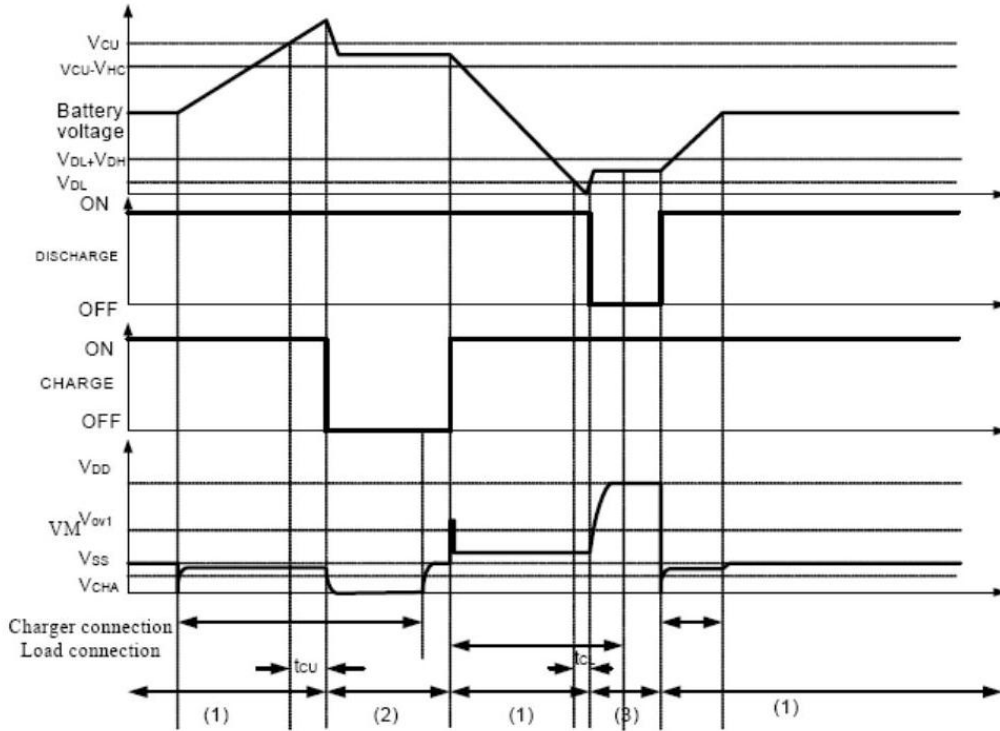

过放电流检测/Overdischarge Current Detection

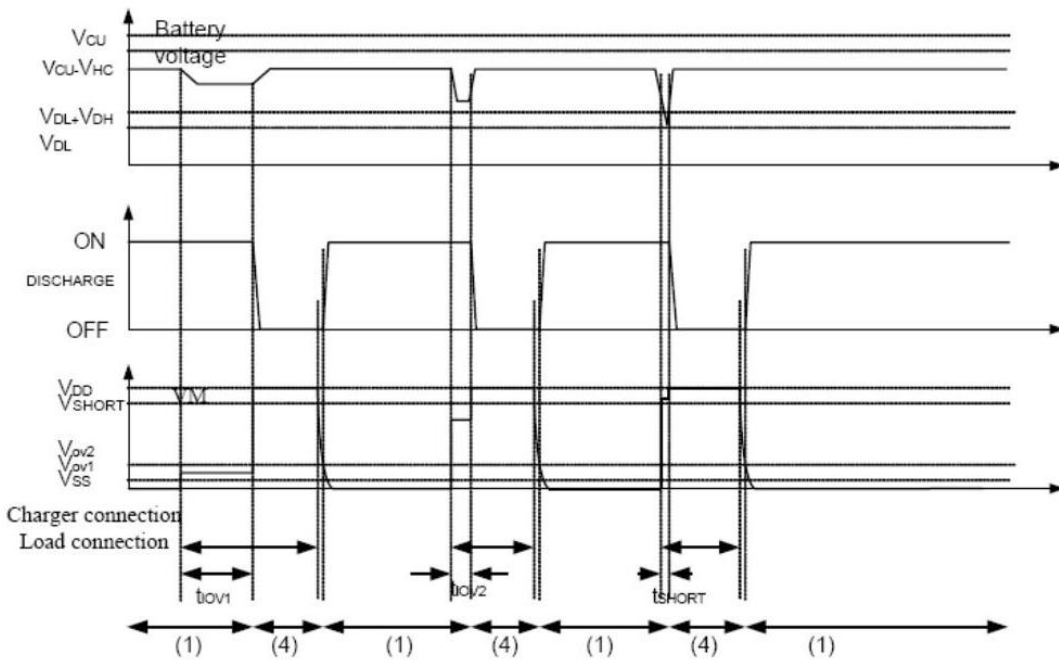

时序图 / Timing Chart

充电器检测/Charger Detection

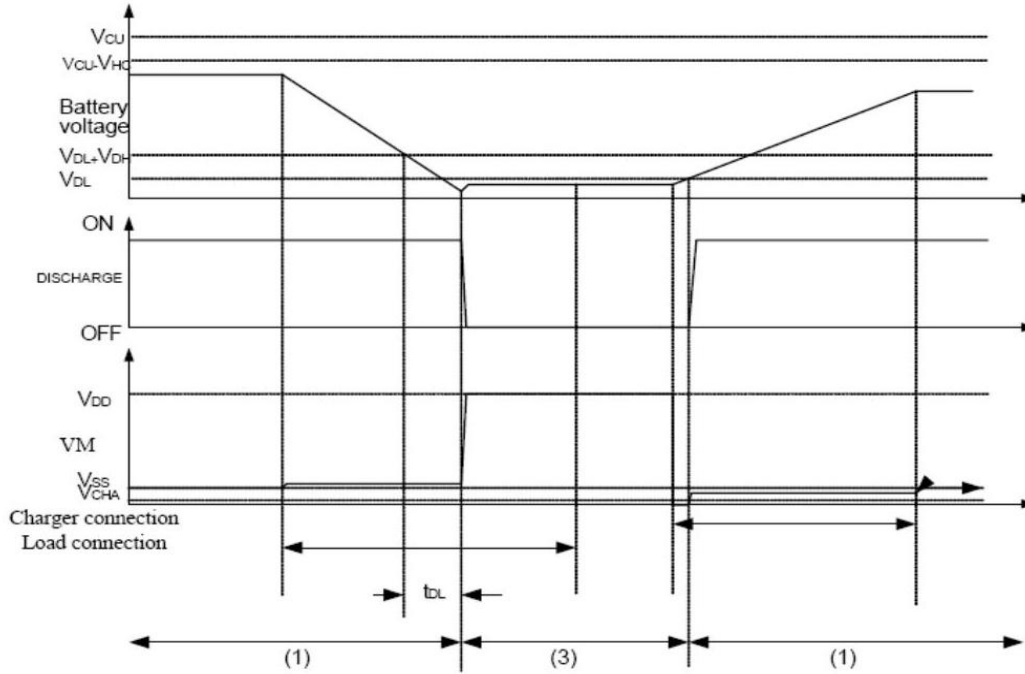

异常充电电流检测/Abnormal Charge Detection

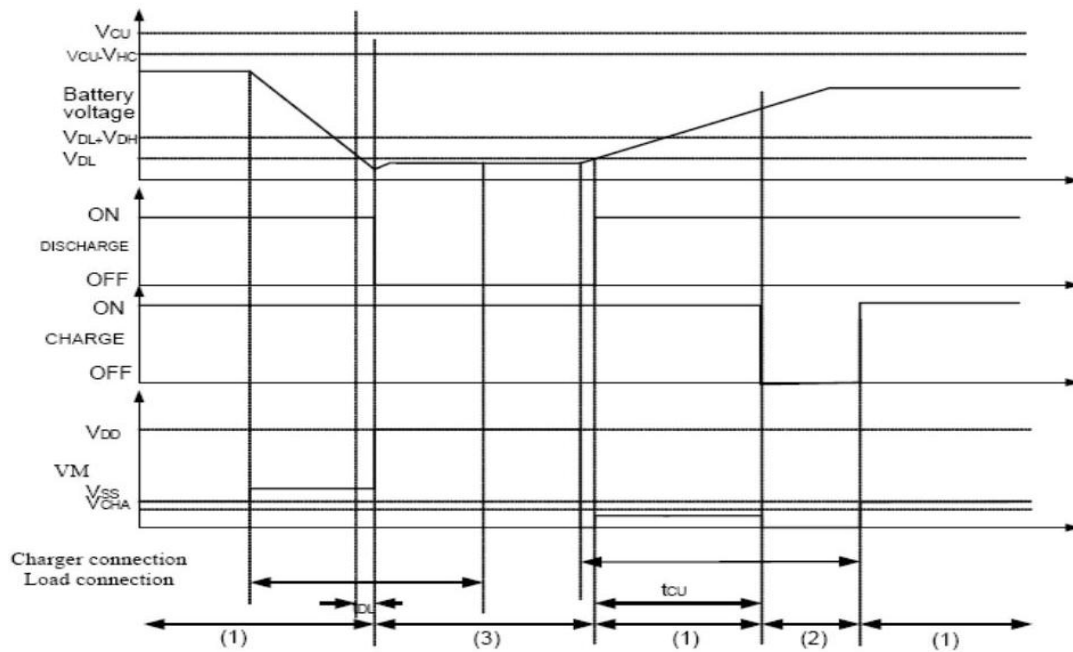

Notes: (1) Normal condition (2) Overcharge voltage condition (3) Overdischarge voltage condition (4) Overcurrent condition

外形尺寸图 / Package Dimensions

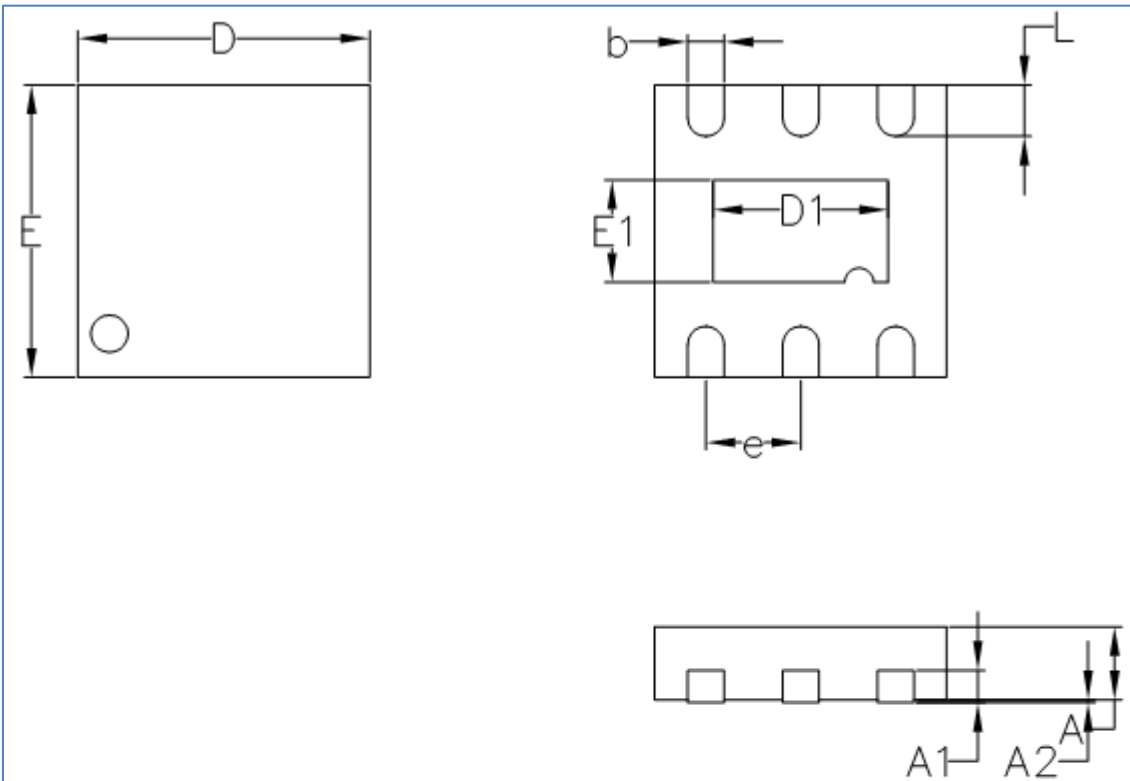

**NOTE: ALL DIMENSIONS IN MM**

	MIN	NOM	MAX
<b>D</b>	1.95	2.00	2.05
<b>E</b>	1.95	2.00	2.05
<b>D1</b>	1.15	1.20	1.25
<b>E1</b>	0.65	0.70	0.75
<b>L</b>	0.30	0.35	0.40
<b>b</b>	0.20	0.25	0.30
<b>e</b>	0.65BSC		
<b>A</b>	0.45	0.50	0.55
<b>A1</b>	0.20REF		
<b>A2</b>	0.00		0.05

印章说明 / Marking Instructions



说明：

3230B： 为产品型号

\*\*\*\*： 为生产批号代码，随生产批号变化。

Note:

3230B: Product Type.

\*\*\*\*: Lot No. Code, code change with Lot No.

**回流焊温度曲线图(无铅) / Temperature Profile for IR Reflow Soldering(Pb-Free)**

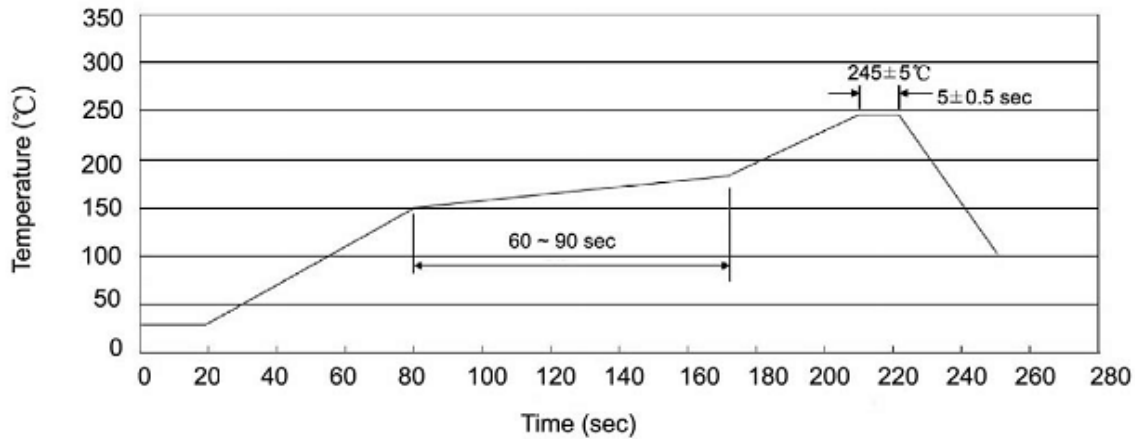

说明：

- 1、预热温度 150~180°C，时间 60~90sec;
- 2、峰值温度 245±5°C，时间持续为 5±0.5sec;
- 3、焊接制程冷却速度为 2~10°C/sec.

Note:

- 1.Preheating:150~180°C, Time:60~90sec.
- 2.Peak Temp.:245±5°C, Duration:5±0.5sec.
3. Cooling Speed: 2~10°C/sec.

**耐焊接热试验条件 / Resistance to Soldering Heat Test Conditions**

温度：260±5°C

时间：10±1 sec.

Temp.:260±5°C

Time:10±1 sec

**包装规格 / Packaging SPEC.**

卷盘包装 / REEL

Package Type 封装形式	Units 包装数量					Dimension 包装尺寸 (unit : mm <sup>3</sup> )		
	Units/Reel 只/卷盘	Reels/Inner Box 卷盘/盒	Units/Inner Box 只/盒	Inner Boxes/Outer Box 盒/箱	Units/Outer Box 只/箱	Reel	Inner Box 盒	Outer Box 箱
DFN2*2-3L/6L	3,000	10	30,000	4	120,000	7" × 8	210×210×205	445×445×230

**使用说明 / Notices**