

### General Description

These N-Channel enhancement mode power field effect transistors are using trench DMOS technology. This advanced technology has been especially tailored to minimize on-state resistance, provide superior switching performance, and withstand high energy pulse in the avalanche and commutation mode. These devices are well suited for high efficiency fast switching applications.

### SOT23-3S Pin Configuration

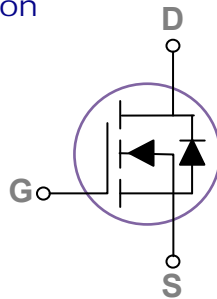
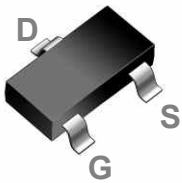

BVDSS	RDSON	ID
20V	65mΩ	4A

### Features

- 20V, 4A,  $R_{DS(ON)} = 65m\Omega @ V_{GS} = 4.5V$
- Improved  $dv/dt$  capability
- Fast switching
- Green Device Available
- Suit for 1.8V Gate Drive Applications

### Applications

- Notebook
- Load Switch
- Hand-Held Instruments

### Absolute Maximum Ratings $T_c=25^\circ C$ unless otherwise noted

Symbol	Parameter	Rating	Units
$V_{DS}$	Drain-Source Voltage	20	V
$V_{GS}$	Gate-Source Voltage	$\pm 10$	V
$I_D$	Drain Current – Continuous ( $T_c=25^\circ C$ )	4	A
	Drain Current – Continuous ( $T_c=100^\circ C$ )	2.5	A
$I_{DM}$	Drain Current – Pulsed <sup>1</sup>	16	A
$P_D$	Power Dissipation ( $T_c=25^\circ C$ )	1.56	W
	Power Dissipation – Derate above $25^\circ C$	0.012	W/ $^\circ C$
$T_{STG}$	Storage Temperature Range	-55 to 150	$^\circ C$
$T_J$	Operating Junction Temperature Range	-55 to 150	$^\circ C$

### Thermal Characteristics

Symbol	Parameter	Typ.	Max.	Unit
$R_{\theta JA}$	Thermal Resistance Junction to ambient	---	80	$^\circ C/W$

**Electrical Characteristics ( $T_J=25^\circ\text{C}$ , unless otherwise noted)**
**Off Characteristics**

Symbol	Parameter	Conditions	Min.	Typ.	Max.	Unit
$BV_{DSS}$	Drain-Source Breakdown Voltage	$V_{GS}=0V, I_D=250\mu A$	20	---	---	V
$\Delta BV_{DSS}/\Delta T_J$	$BV_{DSS}$ Temperature Coefficient	Reference to $25^\circ\text{C}$ , $I_D=1\text{mA}$	---	0.02	---	$V/^\circ\text{C}$
$I_{DSS}$	Drain-Source Leakage Current	$V_{DS}=20V, V_{GS}=0V, T_J=25^\circ\text{C}$	---	---	1	$\mu A$
		$V_{DS}=16V, V_{GS}=0V, T_J=125^\circ\text{C}$	---	---	10	$\mu A$
$I_{GSS}$	Gate-Source Leakage Current	$V_{GS}=\pm 10V, V_{DS}=0V$	---	---	$\pm 100$	nA

**On Characteristics**

$R_{DS(ON)}$	Static Drain-Source On-Resistance	$V_{GS}=4.5V, I_D=3A$	---	50	65	m $\Omega$
		$V_{GS}=2.5V, I_D=2A$	---	60	80	
		$V_{GS}=1.8V, I_D=1A$	---	85	120	
$V_{GS(th)}$	Gate Threshold Voltage	$V_{GS}=V_{DS}, I_D=250\mu A$	0.3	0.5	1	V
$\Delta V_{GS(th)}$	$V_{GS(th)}$ Temperature Coefficient		---	2	---	$\text{mV}/^\circ\text{C}$
gfs	Forward Transconductance	$V_{DS}=10V, I_S=2A$	---	4.4	---	S

**Dynamic and switching Characteristics**

$Q_g$	Total Gate Charge <sup>2,3</sup>	$V_{DS}=10V, V_{GS}=4.5V, I_D=1A$	---	3.6	7.2	nC
$Q_{gs}$	Gate-Source Charge <sup>2,3</sup>		---	0.38	0.76	
$Q_{gd}$	Gate-Drain Charge <sup>2,3</sup>		---	0.6	1.2	
$T_{d(on)}$	Turn-On Delay Time <sup>2,3</sup>	$V_{DD}=10V, V_{GS}=4.5V, R_G=25\Omega$ $I_D=1A$	---	1.8	5	nS
$T_r$	Rise Time <sup>2,3</sup>		---	5.6	12	
$T_{d(off)}$	Turn-Off Delay Time <sup>2,3</sup>		---	11.3	24	
$T_f$	Fall Time <sup>2,3</sup>		---	3.2	7	
$C_{iss}$	Input Capacitance	$V_{DS}=15V, V_{GS}=0V, F=1\text{MHz}$	---	180	360	pF
$C_{oss}$	Output Capacitance		---	32	64	
$C_{rss}$	Reverse Transfer Capacitance		---	26	52	

**Drain-Source Diode Characteristics and Maximum Ratings**

Symbol	Parameter	Conditions	Min.	Typ.	Max.	Unit
$I_S$	Continuous Source Current	$V_G=V_D=0V$ , Force Current	---	---	4	A
$I_{SM}$	Pulsed Source Current		---	---	8	A
$V_{SD}$	Diode Forward Voltage	$V_{GS}=0V, I_S=1A, T_J=25^\circ\text{C}$	---	---	1	V

**Note :**

1. Repetitive Rating : Pulsed width limited by maximum junction temperature.
2. The data tested by pulsed , pulse width  $\leq 300\mu s$ , duty cycle  $\leq 2\%$ .
3. Essentially independent of operating temperature.

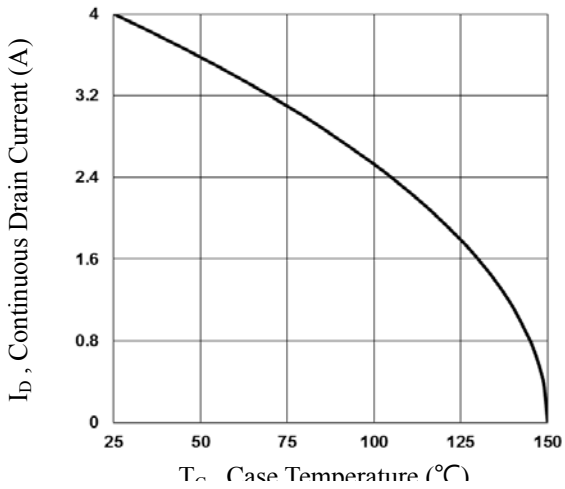

Fig.1 Continuous Drain Current vs.  $T_c$

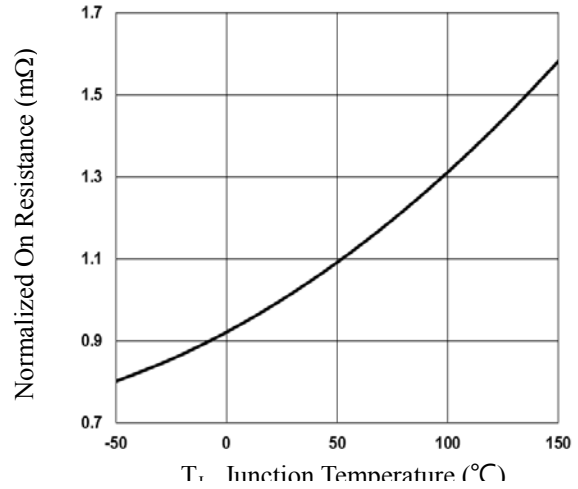

Fig.2 Normalized  $R_{DS(on)}$  vs.  $T_j$

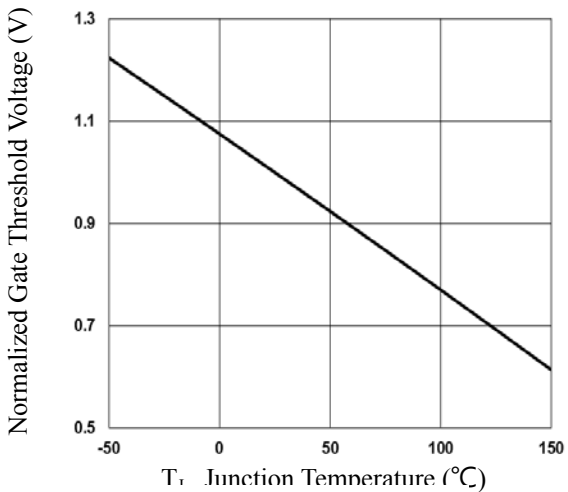

Fig.3 Normalized  $V_{th}$  vs.  $T_j$

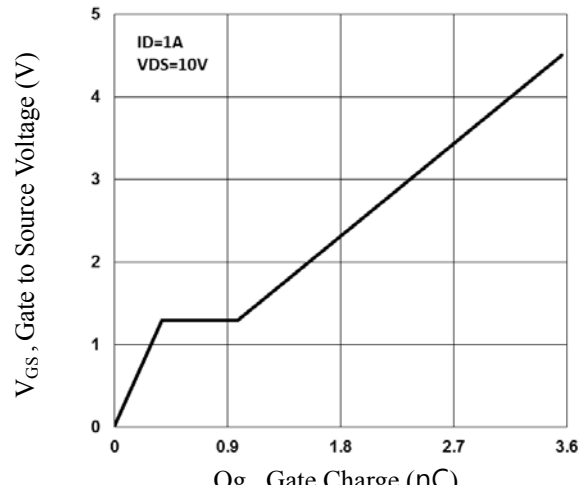

Fig.4 Gate Charge Waveform

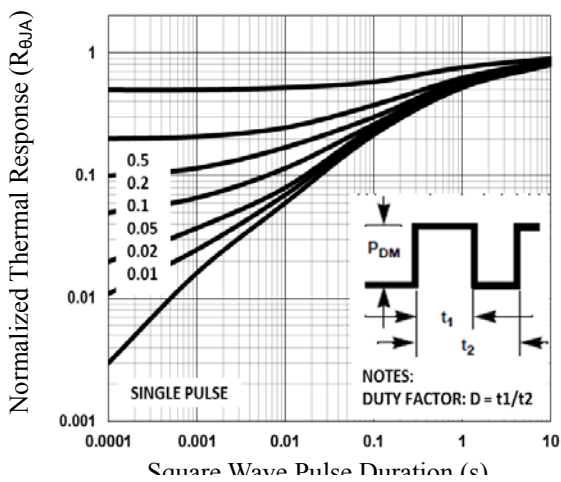

Fig.5 Normalized Transient Impedance

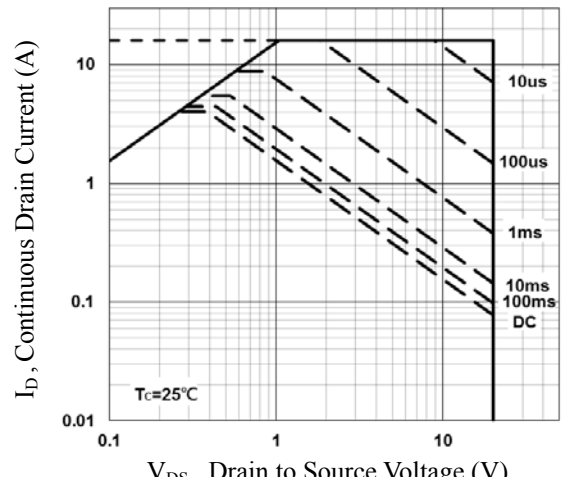

Fig.6 Maximum Safe Operation Area

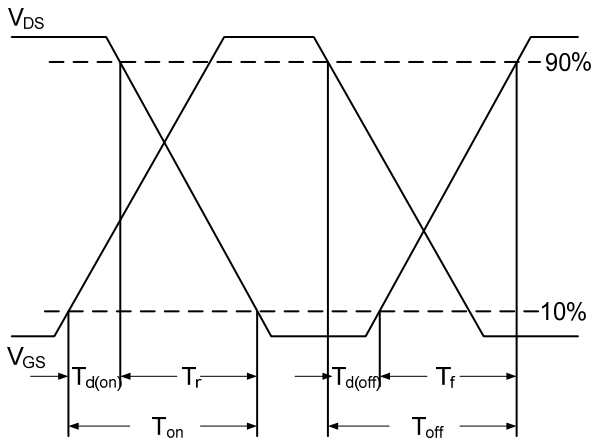

Fig.7 Switching Time Waveform

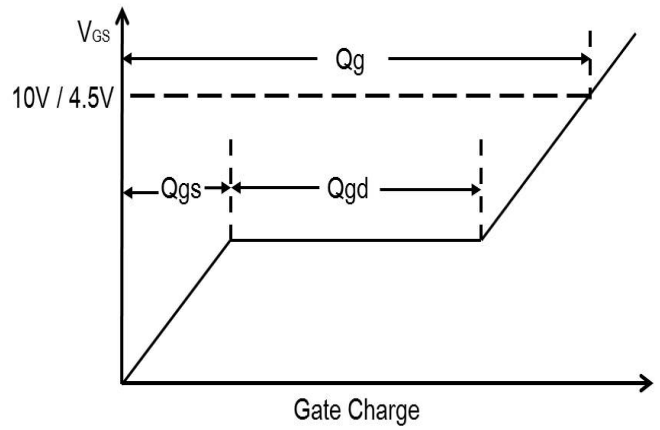
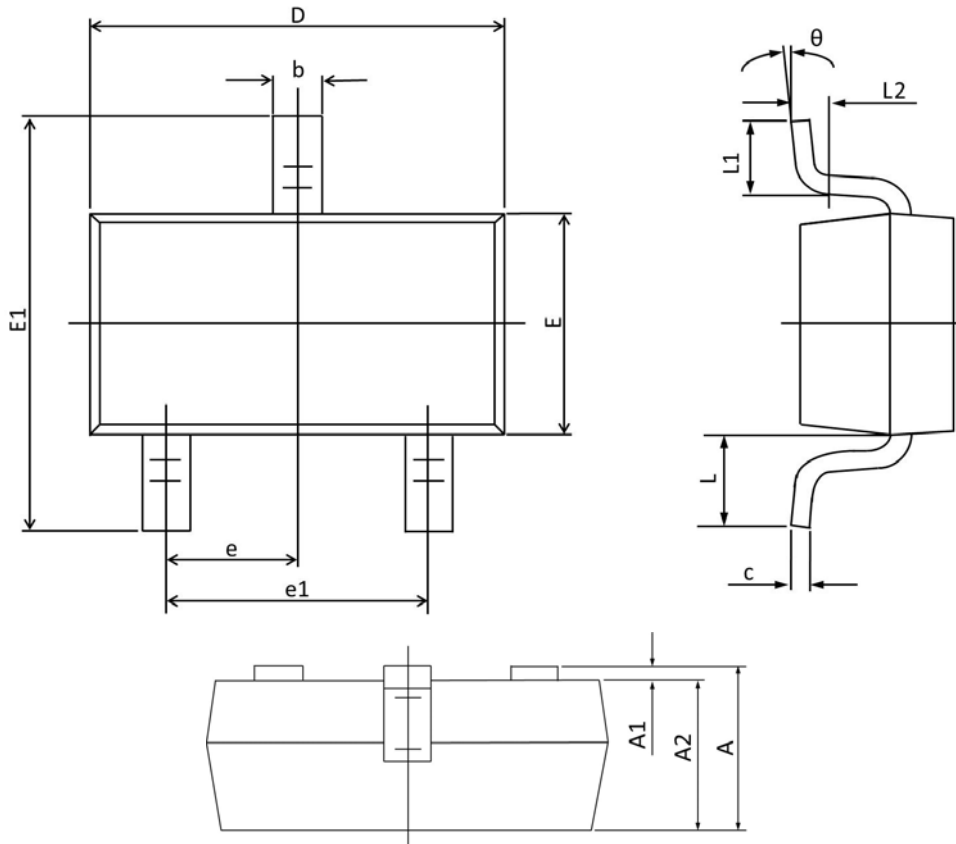

Fig.8 Gate Charge Waveform

### SOT23-3S PACKAGE INFORMATION



Symbol	Dimensions In Millimeters		Dimensions In Inches	
	MAX	MIN	MAX	MIN
A	1.150	0.900	0.045	0.035
A1	0.100	0.000	0.004	0.000
A2	1.050	0.900	0.041	0.035
b	0.500	0.300	0.020	0.012
c	0.150	0.080	0.006	0.003
D	3.000	2.800	0.118	0.110
E	1.400	1.200	0.055	0.047
E1	2.550	2.250	0.100	0.089
e	0.95 TYP.		0.037 TYP.	
e1	2.000	1.800	0.079	0.071
L	0.55 REF.		0.022 REF.	
L1	0.500	0.300	0.020	0.012
L2	0.25 TYP.		0.01 TYP.	
θ	8°	0°	8°	0°