

零件编码原则 Part Number Configuration:

J2 102 M 3A Y5V S T 5 L E

(1) (2) (3) (4) (5) (6) (编带) (7) (8) (9)(10)

(1) 产品类别 DC capacitors, safety

(2) 标称容量 Rated Voltage

(3) 误差 Rated capacitance

(4) 额定电压 Tolerance on rated capacitance

(5) 温度特性 Type code **Temperature Characteristic:**

(B) Y5P, (F) Y5V, (E) Y5U. NP0. SL

(6) 脚型 Lead shape:

S(直角), I(内弯), O(外弯), X(前后弯)

(7) 脚距 Pin pitch :

5.0、7.5、9.5、10.0

(8) 脚长 Lead length:

3—27mm

(9) 涂装材料 color: E 代表 EPOXY,蓝色;

(10) 电极材质 electrode material

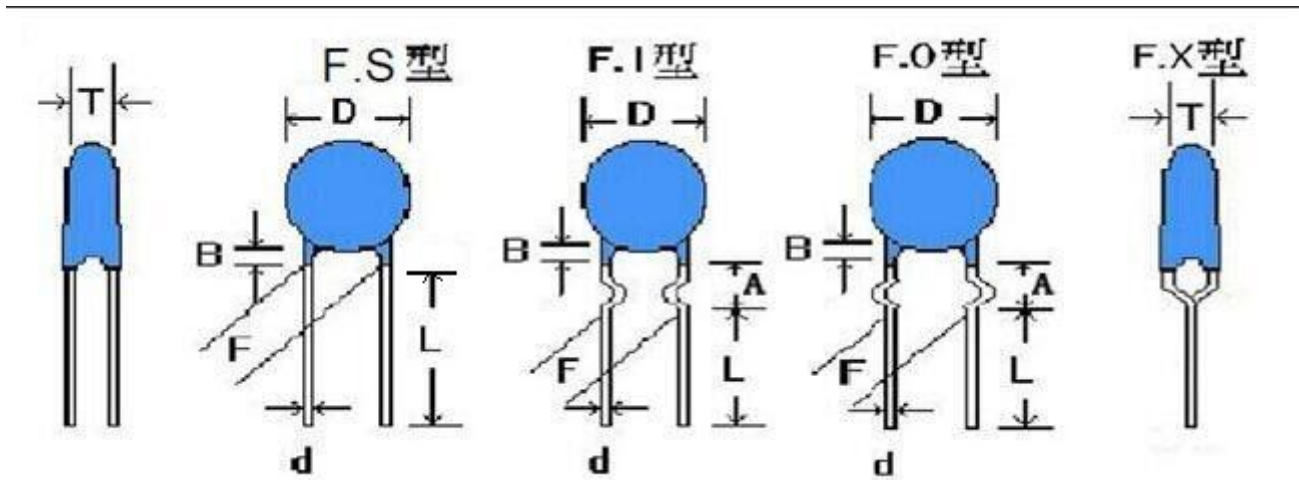

Dimensions and Tolerance

B=3.0mm max for AA

L=3-27mm

承认规格详细参数 (Approved Spec. Data)

品名规格 Approve Item	外径 D(MAX) mm	脚距 F±0.8	脚长 L±1mm	厚度 T±0.5mm	线径 d±0.05mm	绝缘脚 B	涂装材料 color	DF/Q 值	A	备注 note

1. 適用範圍 (Scope of Application)

適用於電子機器、儀 表、通信器材及資訊產品之絕緣圓板形固定陶瓷電容器。

Ideal for use on Electrical Appliance、Instrument、Communication equipment and Information product.

1. 種 類 (Type)

- 2-1 • CLASS 1 溫度補償型(Temperature compensation type) (TC TYPE)
- 2-2 • CLASS 2 高介電常數(High inductivity) (HI - K TYPE)
- 2-3 • CLASS 3 半導體(Semi-Conductive) (SC TYPE)

3 • 工作溫度範圍 (Operating Temperature Range)

- 3-1 • Y 級 (Y Type) (- 25°C — + 85°C)
- 3-2 • Z 級 (Z Type) (+ 10°C — + 85°C)
- 3-3 • X 級 (X Type) (- 55°C — + 125°C)
- 3-4. 使用溫度範圍 (Use temperature range)
Y 級, Z 級 (-40°C - +125°C)

4 • 額定電壓 (Rated Voltage)

- 4-1 • TC & Hi - k . . . 50V • 500V • 1KV • 2KV • 3KV • 6KV • 8KV • 10KV • 15KV (D • C)
- 4-2 • SC 16V • 25V • 50V • 100V
- 4-3 • T.C. 標示法

高压电容: HIGH DIELECTRIC CONSTANT CAPACITOR
B:Y5P/X7R D:Y5T E:Y5U F:Y5V

5 • 溫度特性 (Temperature Characteristics)

5-1 • CLASS 1 (溫度係數 Temperature Coefficient : PPM / °C)

代 號 Code	PPM / °C	溫度係數容許差 Temperature Coefficient Change		顏 色 Color	EIA 規格 Specification	代 號 Code	W • V
		代 號 Code	PPM/ °C				
C	0	H	± 60	黑 black	NPO	C0	50V 15KV
H	-30	H	± 60	棕 brown	N33	S1	
L	-80	H	± 60	红 red	N80	U1	
P	-150	H	± 60	橙 orange	N150	P2	
R	-220	H	± 60	黄 yellow	N220	R2	
S	-330	H	± 60	绿 green	N330	S2	
T	-470	H	± 60	蓝 blue	N470	T2	
U	-750	J	± 120	紫 purple	N750	U2	
D	'-3300	L	± 500	N 330 ± 500		S 2 L	
SL	+ 140 > @ > - 1000						

T • C • CHART

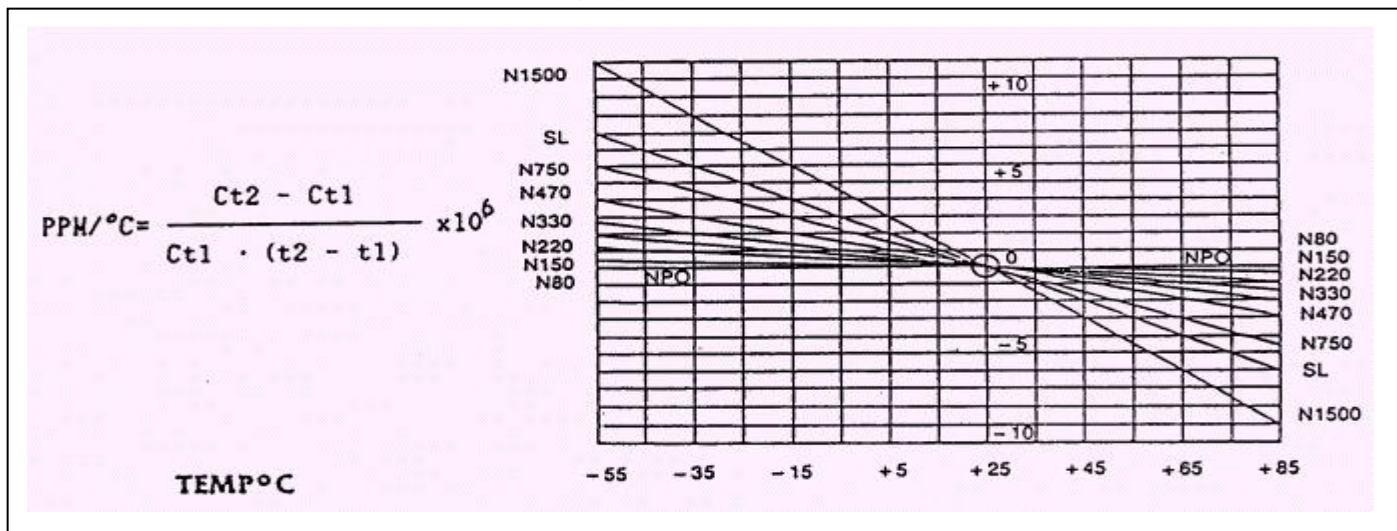

5 - 2 CLASS 2 (溫度變化率 Temperature Coefficient : %)

代 號 Code	溫度範圍 Temperature Range	容量變化率 Capacitance Tolerance	E I A 規格(Specification)		W · V
			代 號 Code	容量變化率 Capacitance Tolerance	
B	-25°C +85°C	+ 10 % / - 10 %	Y5P/YL	+ 10 % / - 10 %	50V-15KV
D		+ 20 % / - 30 %	Y5T/Y5R	+ 22 % / - 33 %	50V-10KV
E	-25°C +85°C	+ 20 % / - 55 %	Y5U/Z5U	+ 22 % / - 56 %	50V-15KV
F		+ 30 % / - 80 %	Y5V/Z5V	+ 22 % / - 82 %	50V-15KV
R	-55°C + 125°C	+ 15 % / - 15 %	X7R	+ 15 % / - 15 %	50V-2KV

5 - 3 CLASS 3 (溫度變化率 Temperature Coefficient : %)

代 號 Code	溫度範圍 Temperature Range	容量變化率 Capacitance Tolerance	E I A 規格(Specification)		W.V
			代號 Code	容量变化率 Capacitance Tolerance	
D	-25°C +85°C	± 15 %	Y5R	±15 %	16V,25V 50V,100V
		+ 20 % - 30 %	Y5T	+22 % -33 %	
+30 % -80 %		Y5V/Z5V	+22 % -82%		
+20 % -55 %		Y5U/Z5U	+22 % -56 %		
R		± 10 %	Y5P	±10 %	

Capacitance Temperature Characteristics

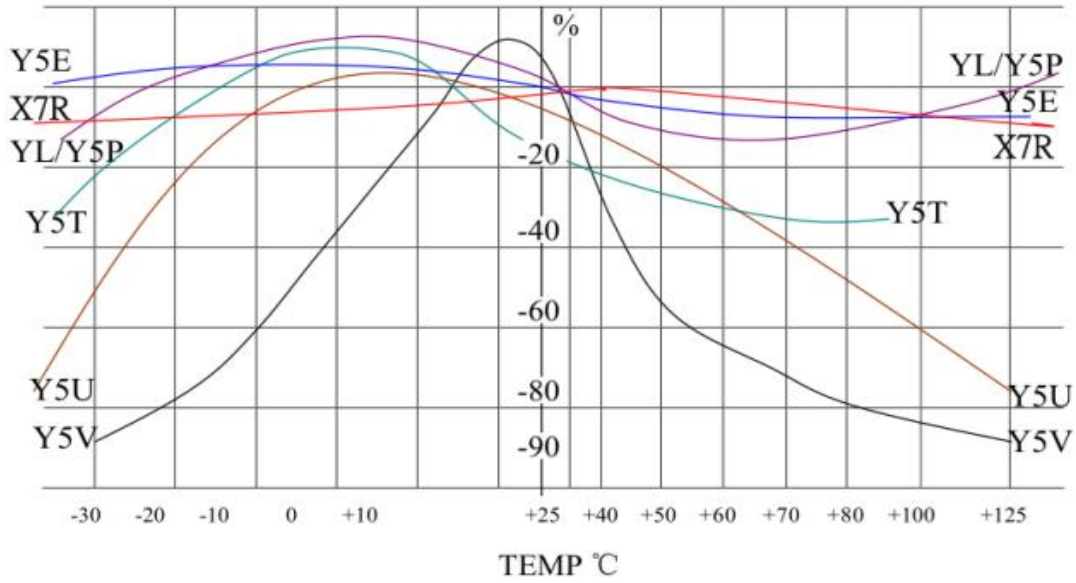

6 • 制品尺寸與容量範圍 (Dimensions and Capacitance Range)

本规格书尺寸,脚距,仅供参考.尺寸如有变化,不另行通知. 请向我司查询或按贵司要求生产.

Size of this specification, foot distance, for reference only. Size change without notice. Please check with us or produce according to your requirement.

6 - 1 CLASS 1

Dimension(mm)			Capacitance Range(PF)						
直徑 Diameter (D)MAX	導線間隔 Lead Space (F)		50V NPO- N750	50V N750	50V SL	500V NPO	500V-3KV	4KV-6KV	8KV-10KV
	直長腳 Straight Lead	彎短腳 Formed Lead							
5.0	2.5 ± 0.8	5.0 ± 0.8	1 - 50	1 - 50	22 - 150				
6.0	5.0 ± 0.8	5.0 ± 0.8	51 - 82	51 - 82	151 - 220	1 - 30	1 - 82	47 - 68	18 - 47
7.0	5.0 ± 0.8	5.0 ± 0.8	82 - 120	83 - 120	240 - 330			82 - 100	56 - 82
8.0	5.0 ± 0.8	5.0 ± 0.8	121 - 180	130 - 180	360 - 470	33 - 47	91 - 160	151 - 221	100
9.0	5.0 ± 0.8	5 ± 0.8	181 - 220	181 - 220	500 - 560			271	151
10.0	5.0 ± 0.8	5.0 ± 0.8	221 - 270	221 - 270	561 - 820	51 - 120	180 - 300	331	181 - 221
12.0	5.0 ± 0.8 7.5 ± 0.8	5.0 ± 0.8 9.25 ± 0.8	271 - 330	271 - 330	561 - 820	51 - 120	180 - 300	331	181 - 221
14.0	5.0 ± 0.8 7.5 ± 0.8		331 - 470	471	170 - 240	470 - 240	470 - 560	561 - 681	391

6 - 2 CLASS 2

EIA 温度特性图 TEMPERATURE CHARACTERISTIC CHART																										
X: - 55°C Y: - 25°C Z: - 10°C	4: + 65°C 5: + 85°C 6: + 105°C 7: + 125°C 8: + 150°C	<table border="1"> <tr><td>A</td><td>± 1.0 %</td></tr> <tr><td>B</td><td>± 1.5 %</td></tr> <tr><td>C</td><td>± 2.2 %</td></tr> <tr><td>D</td><td>± 3.3 %</td></tr> <tr><td>E</td><td>± 4.7 %</td></tr> <tr><td>F</td><td>± 7.5 %</td></tr> <tr><td>P</td><td>± 10 %</td></tr> <tr><td>R</td><td>± 15 %</td></tr> <tr><td>S</td><td>± 22 %</td></tr> <tr><td>T</td><td>± 22 % - 33%</td></tr> <tr><td>U</td><td>± 22 % - 56%</td></tr> <tr><td>V</td><td>± 22 % - 82%</td></tr> </table>	A	± 1.0 %	B	± 1.5 %	C	± 2.2 %	D	± 3.3 %	E	± 4.7 %	F	± 7.5 %	P	± 10 %	R	± 15 %	S	± 22 %	T	± 22 % - 33%	U	± 22 % - 56%	V	± 22 % - 82%
A	± 1.0 %																									
B	± 1.5 %																									
C	± 2.2 %																									
D	± 3.3 %																									
E	± 4.7 %																									
F	± 7.5 %																									
P	± 10 %																									
R	± 15 %																									
S	± 22 %																									
T	± 22 % - 33%																									
U	± 22 % - 56%																									
V	± 22 % - 82%																									
第一个 最低温度 First Digit is low Temperature	第二个 最高温度 Second Digit is High Temperature	最后一个字母 电容量变化, 温度范围 25°C. Last Digit is Capacitance Change Over Temperature Range From + 25 C Reading																								

尺寸 Dimension (MM)	直徑 Diameter (D) MAX		5.0	6.0	7.0	8.0	9.0	10.0	12.0	14.0	16.0
	Space 导线间隔 (F) Lead										
	彎短腳 Formed Lead		5.0±0.8	5.0 ± 0.8	5.0± 0.8	5.0 ± 0.8	7.5± 0.8	7.5±0.8 9.5&10.0±0.8			
		直短腳 Straight short Lead	5.0±0.8	5.0 ± 0.8	5.0 ± 0.8	5.0 ± 0.8	5.0 ± 0.8 7.5 ±0.8	7.5±0.8 9.5&10.0±0.8			
		直長腳 Straight long Lead	2.5±0.8	5.0 ± 0.8	5.0 ± 0.8	5.0 ± 0.8	5.0 ± 0.8 7.5 ±0.8	7.5± 0.8 9.5± 0.8			
50V	B		101 - 222	272 - 330	392 - 472	562 - 682	752 - 822				
	D		102 - 152	182 - 272	332 - 432	562 - 682	472 - 562	822 - 103		473 - 503	
	E		102 - 103	682 - 103	123	153	183 - 203	223			
500V	F		102 - 103	153 - 203	223		303 - 403	473 - 503			
	B		101 - 102	122	152 - 182	202 - 222	242 - 332	362 - 472	512 - 682	752 -	
	E		101 - 222	242 - 332	392 - 502	562 - 682	822	103	153	203 -	303 - 333
1KV	F		102 - 392	472 - 502	562	682 - 103	153	183	203 - 223		333 - 473
	B		101 - 500	561 - 102	122 - 152	182	202 - 222	272 - 332	392 - 472	562 -	822 - 103
	E		101 - 102	152 - 222	272	302 - 392	472 - 562	682 - 103	153	203 -	303 - 333
2KV	F		102 - 122	152 - 182	202 - 222	272 - 332	392 - 103	123	153 - 183	203 - 333-	473 - 104
	B			101 - 561	681	821 - 102	122 - 152	182 - 222	272 - 332	392 -	682 - 822
	E			102 - 122	152 - 182	202 - 272	332	392 - 472	562	682 -	153
3KV	F		101 - 102	102 - 182	202 - 222	272 - 332	392 - 472	562 - 682	822 - 103	153 -	203
	B			101 - 471	561 - 681	821	102 - 122	152	182 - 222	272 -	392 - 472
	E			102 - 122	152 - 182	202 - 222	272	332 - 392	472 - 562	682 -	822 - 103
6KV	F			102 - 182	202 - 222	272	332 - 472	562	682	822 -	153 - 183
	B		101		10 - 82	101 - 471	561 - 681	102			
	E				471 - 102	152 - 182	222	272	332 - 472	682	103
8KV-15KV	F				102 - 222	152 - 222	332 - 392	472	682	103	
	B			10 - 82	101 - 331	471	561 - 681	821 - 102	122	182	
	E				471 - 561	681 - 102	122	152 - 182	222	222 -	472
					102	152 - 182	222 -	272 - 332	472		

6-2 CLASS 3

尺寸 Dimension (MM)	直徑 Diameter (D) MAX		5.0	6.0	7.0	8.0	10.0	11.0	12.0	14.0	
	导线间隔 (F) Lead Space	彎短腳 Formed Lead	5.0 ± 0.8	5.0 ± 0.8	5.0 ± 0.8	5.0 ± 0.8	5.0 ± 0.8	7.5 ± 0.8	7.5 ± 0.8	10.0 ± 0.8	10.0 ± 0.8
		直短腳 Straight short Lead	2.5 ± 0.8	5.0 ± 0.8	5.0 ± 0.8	5.0 ± 0.8	5.0 ± 0.8	7.5 ± 0.8	7.5 ± 0.8	10.0 ± 0.8	10.0 ± 0.8
		直長腳 Straight long Lead	2.5 ± 0.8	5.0 ± 0.8	5.0 ± 0.8	5.0 ± 0.8	5.0 ± 0.8	7.5 ± 0.8	7.5 ± 0.8	10.0 ± 0.8	10.0 ± 0.8
容量范围 Capacitance Range (PF)	16 V	D Y5R	103		223	473			104		
		D Y5T	223	473 - 104							
		F Y5V	473	104							
		E Y5U	223 - 473	104							
	25 V	D Y5R	103			223	473		103		
		D Y5T	103	223		473		104	103	223	
		F Y5V	223	473 - 104	154	224			223	473 - 104	
		E Y5U	153 223	473	104				153 - 223	473	
	50V 100V	F Y5V	223	473	104		224				
		E Y5U								104	
		B Y5P	103								

7. 靜電容量與容許差 (Capacitance & Tolerance) :

7-1 CLASS 1

靜電電容 Capacitance		容許差 Tolerance			
		代號 Code	容量 Capacitance	代號 Code	容量 Capacitance
1	- 5 PF	C	± 0.25 PF	D	± 0.5 PF
6-	- 821 PF	J	± 5 %	K	± 10 %

7-2 CLASS 2

50V	容許差 Tolerance		500V 15KV	容許差 Tolerance	
	代號 Code	%		代號	%
B	K	± 10 %	B	K	± 10 %
D	M	± 20 %	R	L	± 15 %
F	Z	+ 80 % - 20 %	F	Z	+ 80 % - 20 %
E	M	± 20 %	E	M	± 20 %
	Z	+ 80 % - 20 %		Z	+ 80 % - 20 %
	P	+ 100 % - 0 %		P	+ 100 % - 0 %

7-3 CLASS 3

16V 50V	容許差 Tolerance		16V 50V	容許差 Tolerance	
	代號 Code	%		代號 Code	%
D (Y5R)	K	± 10 %	B (Y5P)	K	± 10 %
D (Y5T)	M	± 20 %	E (Y5U)	M	± 20 %
F (Y5V)	Z	+ 80 % - 20 %	R (X7R)	K	± 10 %

8.性能與試驗 (Performance and Testing)

本规格承认书所列之名称制品规格之性能及一般试验, 特殊試驗均符合及依據 EIA RS 198, JIS C 6422, 423, GB/T 2693 等规格。

The specification recognizes the performance and general test of the product specification listed in this specification, Special tests are in accordance with and basis EIA RS 198, JIS C 6422, 6423, GB/T 2693 Specifications such as

注意: 1. 依国际规范定义, 耐压测试时, 零件承认或周期性试验测试为一分钟, 经一分钟测试之部品需报废处理。(此测试条件带有破坏性测试)

"Note: (1) Is was defined according with IEC, when for qualification approval and periodic tests, the withstanding test must last to 1 minute, and it belong to destroyed test domain, therefore, after the test, capacitors should be scrap. Withstand voltage test should rise slowly at 150V/s, and test time is counted from when the voltage reaches to experiment requirement." (Capacitors may cause to damage when withstand voltage test repeated.)

2. 批量生产时测试时间为三秒钟, 耐压测试应为缓升或零启动。

(2) The test time is more than 1 second at production period, and the rated test voltage is applied.

表(sheet) 1			
No	項目 Item	性能 Performance	試驗方法 Test method
1	外觀及尺寸 Appearance and Dimensions	參考 6 , 9 , 10 頁之圖表 refer to charts on page (6, 9, 10)	1-1 生產線必須做全數外觀檢驗並分別剔除不良品。 1-2 尺寸利用微測儀或卡尺測量。 "Production line visual inspection must be done in full and remove the defective products." Dimensions should be measured with slide calipers and micrometers.
2	記號標示 Marking	必須幹淨及清晰。 had to cleanness and clearly	2-1 標示需能承受溶劑擦拭。 Marks need can bear solvent wipe.
3	耐電壓 Withstanding Voltage	端子間 Between Lead Wires 無任何異常發生。 No failure	3-1 試驗電壓為額定電壓之倍數。 The test voltage is a multiple of the rated voltage. CLASS I 和 II (50V-500V 為三倍), (CLASS III 與 1KV~2KV 為兩倍), 3KV -4KV 為 1.5 倍, 5~6KV 為 1.2 倍。 3-2 特殊產品按實際額定電壓。8KV 以上為 1.0 倍。印加時間為 1 ~ 5 秒。充放電流限於 50 MA 以下。 CLASS 1~2 Test voltages were three times rated , (CLASS 3 and over 1~2KV type is 2 times) 3~4KVtype is 1.5 times, 5~6KVtype is 1.2 times, >8KVtype is 1 timestest. times 1 ~ 5 sec. Charge / discharge current ≦50mA)
	端子與外裝間 Body Insulation	無任何異常發生。 No failure	3-3 使用金屬小球法或金屬箔法, 以額定電壓之 2.5 倍加於端子與塗裝外層間。 參閱 GB/T2693 或 CNS 3432 。 Test with metal pellet method, 2.5 times of rated voltage is applied between the lead wires and coated. See GB/T2693 or CNS 3432
4	絕緣電阻 (端子間) Insulation Resistance (Between Lead Wires)	CLASS 1	絕緣電阻之測定電壓 Measure voltage of insulation resistance
			額定電壓 rated voltage
			測定電壓 Testing Voltage
		CLASS 2	(VR/VC)< 10V
			(VR/VC) ±10%
	10V ≦ (VR/VC) <100V	10 ± 1V	
	100V ≦ (VR/VC) <500V	100 ± 15V	
	500V ≦ (VR/VC)	500 ± 50V	
	CLASS 3 16V 50V . 25V	100 MΩ 或 10 ΩF 之較小值以上 ≧100 MΩ or 10 ΩF, Take the small one.	VR 表示額定電壓, VC 表示類別電壓。 用絕緣電阻計按上表施加電壓兩端子間, 60S 後讀其絕緣電阻值。 VR represents the rated voltage., VC represents the class voltage., The insulation resistance meter is used to apply voltage two terminals to the upper table, and the insulation resistance value is read after 60 seconds.
	1000 MΩ 或 20 ΩF 之較小值以上 ≧1000 MΩ or 20 ΩF, take the small one.		
5	靜電容量 Capacitance	必須符合要求之容許差規格內。 Within specified tolerance	5-1 測定溫度 should be measured at 25 ± 2 °C
			5-2 測定電壓 measured with this voltage: CLASS 1 < 5 V rms CLASS 2 < 3 V rms CLASS 3 < 0.1 V rms
			5-3 測定頻率 measured with frequency range:
			Class 1
	Class 2, Class 3	1 K H z ± 10 %	

编号 No	项目 Item	性能 Performance		试验方法 Test Method				
6	Q/tan σ (%)	CLASS 1 : Q/tan σ (%)		6-1	與第 5 項同。 same as item 5			
		< 30PF Q ≧ 400+20 × C						
		> 30PF Q ≧ 1,000						
		CLASS 2 : tan σ (%)						
		D、B、E 特性 features: 2.5% Max F 特性 features: 5.0% Max						
CLASS 3 : tan (%)		16V		7.0% Max				
		50V 25V		5.0% Max				
7	靜電容量 溫度特性 Temperature Characteristics	CLASS 1	容量漂移 Capacitance Change	必須符合 5-1 之規格 should be meet the specified range at 5-1	7-1	溫度係數 Temperature Coefficient: (CLASS 1) $PPM / ^\circ C = \frac{C_{t2} - C_{t1}}{C_{t1} \cdot (t2 - t1)}$ C t2 : 在 t2 時之容量值 (C t2 : at t2 value) C t1 : 在 t1 時之容量值 (C t1 : at t1 value) t2 : 85 °C ± 3 °C t1 : 20 °C ± 2 °C 溫度階段 Temperature step 〈1〉 20 ± 2 °C → 〈2〉 -25 ± 2 °C → 〈3〉 20 ± 2 °C → 〈4〉 85 ± 2 °C → 〈5〉 20 ± 2 °C		
			容量漂移 Capacitance Change	在 ±0.2% 或 ±0.05 PF 以內, 取較 大者為準。 within ± 0.2 % or ± 0.05 PF, take the larger.			7-2	
		CLASS 2、3	無電壓時 Non bias	必須符合 5-2、5-3 之規格。 should be meet the specified range at 5-2 5-3。	7-3		容量變化率 Capacitance change rate: (CLASS 2、3) $C \cdot C (\%) = \frac{(C_{tx} - C_{t20})}{C_{t20}} * 10$ C tx : 溫度階段 〈1〉 〈3〉 〈5〉 除外, 〈2〉 到 〈4〉 之間任何溫度時之容量值。 C tx : Capacitance at temperature step(2) & (4), but (1), (3), (5)exclusion. C t20 : 溫度階段 〈3〉 時之容量值。 C t20 : Capacitance at temperature step (3).	
			加壓於兩 端子間時 Bias between two terminals	B : +10% -20% D : +20% -40% E : +20% -80% F : +30% -95%				
8	端子強度 Robustness of Terminations	抗拉強度 Tensile	導線不斷裂, 電容器不破損 Lead wire should not be cut off. Capacitor should not be broken.	8-1	線 徑 Lead Dia. (mm)	負荷重 Loading kgs	時間 (秒) Time (sec)	
					∅ 0.5	0.5	10	
				8-2	∅ ∅ 0.6~0.8	1.0	10	
					制品固定, 負荷施力方向為端子引出之方 向。 Fix the body of the capacitor and apply a tensile weight gradually to each lead wire in the radial direction.			
		彎曲強度 Bending	導線不致被折斷, 電容器不損。 Lead wire should not be cut off. Capacitor should not be broken.	8-3	線徑 Lead Dia. (mm)	負荷重 Loading kgs	彎曲角度為 90。兩回以上 Each lead wire should be a 90° bend in the opposite Direction of more two bends.	
			∅ 0.5	0.25				
			∅ ∅ 0.6~0.8	0.5				

编号 No	项目 Item	性能 Performance		试验方法 Test Method		
9	耐振性 Vibration Resistance	外觀 Appearance	無顯著之異常 No marked defect	9-1	振動頻率 10 → 55 → 10 HZ 一分鐘內完全成覆振動全振幅 1.5 mm Vibrated at a frequency range of 10 → 55 → 10 HZ with about a 1 minute 1.5mm in total amplitude	
容量變化 Capacitance	在規格範圍內 Within the specified tolerance	Q 或 tan σ Q or tan σ	在初期規格內 Within the specified tolerance			
10	焊錫耐熱性 Soldering heat-resistance	外觀 Appearance	無顯著之異常 No marked defect			10-1 10-2 10-3 10-4
容量變化 Capacitance Change	CLASS 1	在 ± 2.5 % 或 ± 0.25PF 以內取較大值。 within ±2.5% or ± 0.25PF, takes bigger value.	CLASS 2 3	B : ≤ ± 5 % D : ≤ ± 10% E : ≤ ± 15% F : ≤ ± 20%		
耐电压 Dielectric Strength	无任何异常发生 No failure					
11	焊錫附着性 Solderability of Leads	導線之橫截面積上須有圓周之 3/4 以上之面積為焊錫所付著。 Lead wire should be soldered with uniform coating on the axial direction over 3/4 of the circumferential direction.		11-1 11-2	焊錫溫度為 275 ± 10 °C Soldering Temperature 275 ± 5°C 浸漬時間為 2 ± 0.5 秒。 Dipped time 2 ± 0.5 seconds.	
12	耐溶劑性 (本體) Solvent Resistance (Body)	試驗後其電性能須符合標準。 After the test must meet the standards of its electrical properties			將樣本完全浸漬於丙醇溶劑中 5±0.5 分後取出，觀察本體有無溶解，而後放置於常溫中 48 小時，量測其電氣特性。 The capacitor should be immersed into a isopropyl alcohol for 5±0.5 minutes, then removed and placed for 48 hrs. at room condition before post measurements.	

编号 No	项目 Item	性能 Performance			试验方法 Test Method		
13	耐濕性 Humidity (Under Steady State)	外觀 Appearance		無顯著之異常 No marked defect	13-1		
		容量變化 Capacitance Change	CLASS S 1	在±2.5%或±0.5PF 以內取較大值。 within ±2.5% or ±0.5PF, takes bigger value.		13-2 13-3 13-4	
			CLASS S 2-3	B : ≤ ± 5 % D : ≤ ± 10% E : ≤ ± 15% F : ≤ ± 20%			
		Q	CLASS 1	參考附圖 1 Refer to attached figure 1.			
		Tan σ (%)	CLASS 2-3	B、D、E 特性在5%以下,F特性7.5%以下 B、D、E, < 5%. F, < 7.5 %			
			CLASS 1	≧ 1000 MΩ			
			CLASS 2	≧ 1000 MΩ or 20 ΩF, 取小者.take the small one.			
			CLASS 3	16V	≧ 50 MΩ or 5 ΩF,取小者.take the small one.		
			25V 50V	≧ 500 MΩ or 20 ΩF, 取小者.take the small one.			
		耐電壓 Dielectric Strength	無任何異常 No failure			溫度 : 40 ± 2 °C Temperature : 40 ± 2 °C 濕度 : 90 ~ 95 % RH Humidity: 90 ~ 95 %RH 時間 : 500 ± 12 小時 Time : 500 ± 12 Hrs. 取出置常溫下 1 ~ 2 小時后測定之 After humidity test, placed at room condition 1~ 2 hrs, then measure it.	

编号 No	项目 Item	性能 Performance				试验方法 Test Method				
14	耐濕負荷 Humidity Loading	外觀 Appearance		無顯著之異常 No marked defect		14-1	溫度: 40 ± 2 °C Temperature : 40 ± 2 °C 濕度: 90 ~ 95 % RH Humidity: 90 ~ 95 % RH 時間: 500 ± 12 小時 Time : 500 ± 12 Hrs 電壓: 依額定電壓印加之。 Voltage: Apply the rated voltage 電流: 50 MA 以下。 Current: < 50 MA 取出置常溫下 1~2 小時后測定之 After humidity test, placed at room condition 1~ 2 hrs, then measure it.			
		容量 變化 Capacitan ce Change	CLASS 1	在±7.5%或±0.75 PF 以內取較大值。 within ± 7.5% or ± 0.75 PF, take the lage one.		14-2		14-3	14-4	
			CLASS 2-3	B : ≤ ± 5 % D : ≤ ± 10% E : ≤ ± 15% F : ≤ ± 20%		14-5		14-6		
		Q	CLASS 2	參考附圖 1 Refer to attached figure 1.				CLASS 1,2	≥ 500 M Ω	
			CLASS 2	B、D、E、< 5 % F < 7.5 %		絕緣電阻 Insulation Resistance		CLASS 3	16V ≥ 50 M Ω or 5 Ω F, 之較小值上 take the small one.	
		Tan σ (%)	CLASS 3	16V	<10%			25V 50V	≥ 500M Ω or 20 Ω F 之 較小值以上 take the small one.	
		25V 50V	<7.5%		耐電壓 Dielectric Strength	無任何異常 No failure				

编号 No	项目 Item	性能 Performance		试验方法 Test Method		
15	高温 负荷 High temper ature loadin g	外觀 Appearance	無顯著之異常 No marked defect	15-1 15-2 15-3 15-4 15-5		
		容量 變化 Capacitance Change	CLASS 1	在 ±3%或±0.3 PF 以內取較大 值。 Within ± 3% or ± 0.3 PF, take the lage one.	溫度: 85 ± 3 °C Temperature : 85 ± 3 °C 時間: 1000 ± 12 小時 Time : 1000 ± 12 hrs 電壓: 依額定電壓印加之。 Voltage: Apply the rated voltage 電流: 50 MA 以下。 Current: < 50 MA 取出置常溫下 1~2 小時后測定之 After humidity test, placed at room condition 1~ 2 hrs, then measure it.	
			CLASS 2-3	B : ≤ ± 5 % D : ≤ ± 10% E : ≤ ± 15% F : ≤ ± 20%		
		Q	CLASS 1	參考附圖 1 Refer to attached figure 1.		
		Tan σ (%)	CLASS 2	B、D、E 特性在 4% 以下 Char. B、D、E, < 4 % F 特性 7.5% 以下 Char. F < 7.5 %		
			CLASS 3	16V		< 10 %
		25V 50V		< 7.5 %		
		絕緣 電阻 Insulati on Resista nce	CLASS 1	1000MΩ 以上 ≧ 1000MΩ		
			CLASS 2	≧ 1000 MΩ or 20 Ω F, 取小 者。take the small one.		
			CLASS 3	16V		≧ 50 MΩ or 5 Ω F, 取小者.take the small one.
25V 50V	≧ 500 MΩ or 20 Ω F, 取小者.take the small one.					
耐電壓 Dielectric Strength	無任何異常 No marked defec					

附圖一 Attached figure 1	適用項目 Applied Item	規格值 Specification
	初期值 <5> 耐振性 <9> Initial Value <5> Vibration Resistance <9>	≧ 30PF Q ≧ 1000 < 30PF Q ≧ 400+20 C
	溫度以及浸漬循環 <12> 耐濕性 <13> , 高溫負荷 <15> Temperature and immersion cycle <12> , Humidity <13> , High temperature loading <15>	≧ 30PF Q ≧ 350 10PF~30PF Q ≧ 275+5 / 20 C < 10PF Q ≧ 200 +10 C
	耐濕負荷 <14> Humidity Loading <14>	≧ 30PF Q ≧ 200 < 30PF Q ≧ 100+ 10 / 3 C

成品之編碼原則上以十五碼完成，亦以阿拉伯數字與英文字母混合編成，第二碼至第十一碼與瓷片相同。第一碼以 J 代表自製（取 JEC 商標第一字）

The coding of the finished product is in principle 15 codes, which are mixed with Arabic numerals and English letters
 Sizes 2 to 11 are the same as the tiles The first code is represented by J (take the first word of JEC trademark).

例： J2472M3AY5VS5LE (Y5V 472M/1KV 5*25)

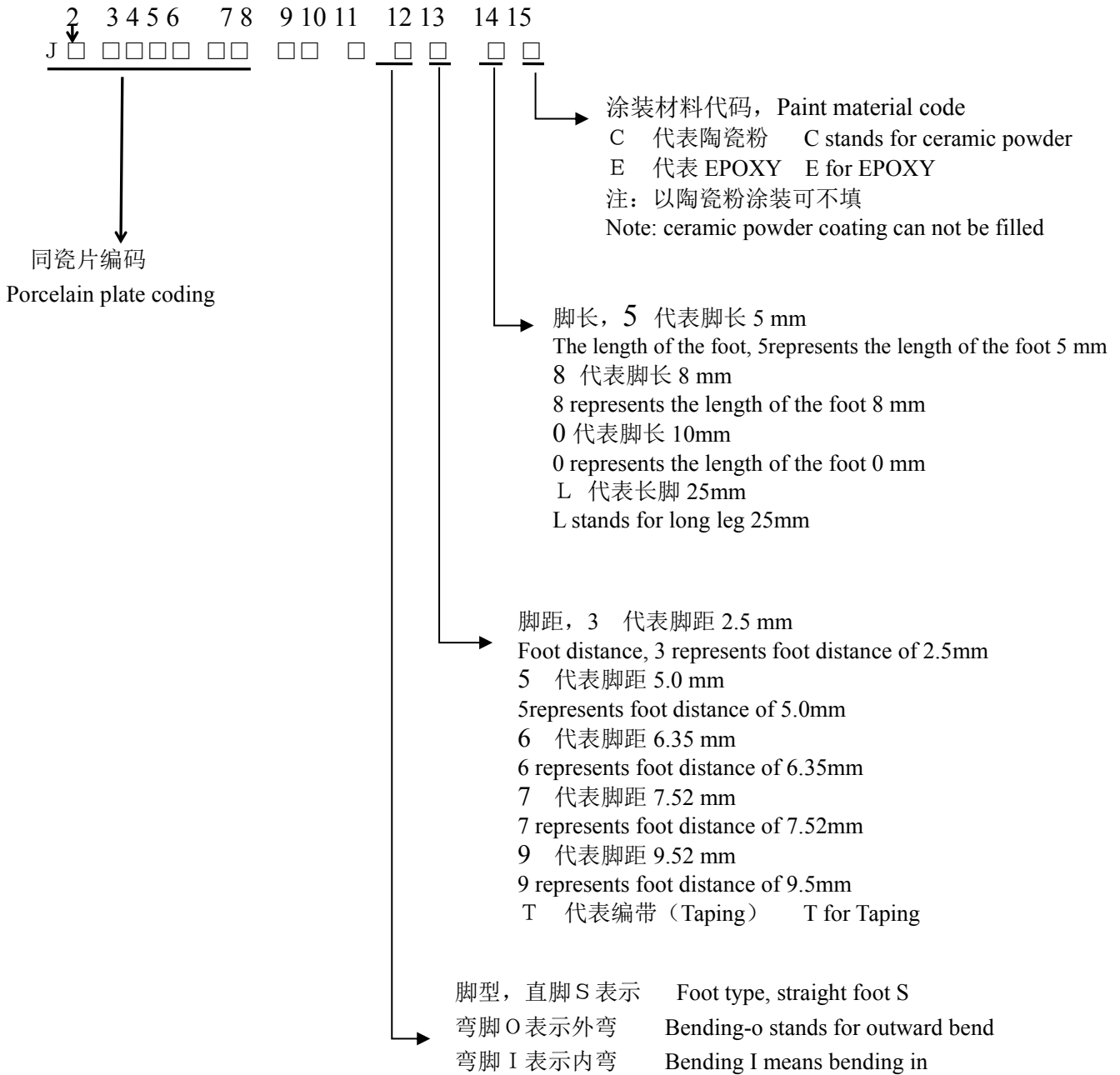

陶瓷瓷片 2-11 編碼規定如下:

The coding of ceramic tiles 2-11 is specified as follows

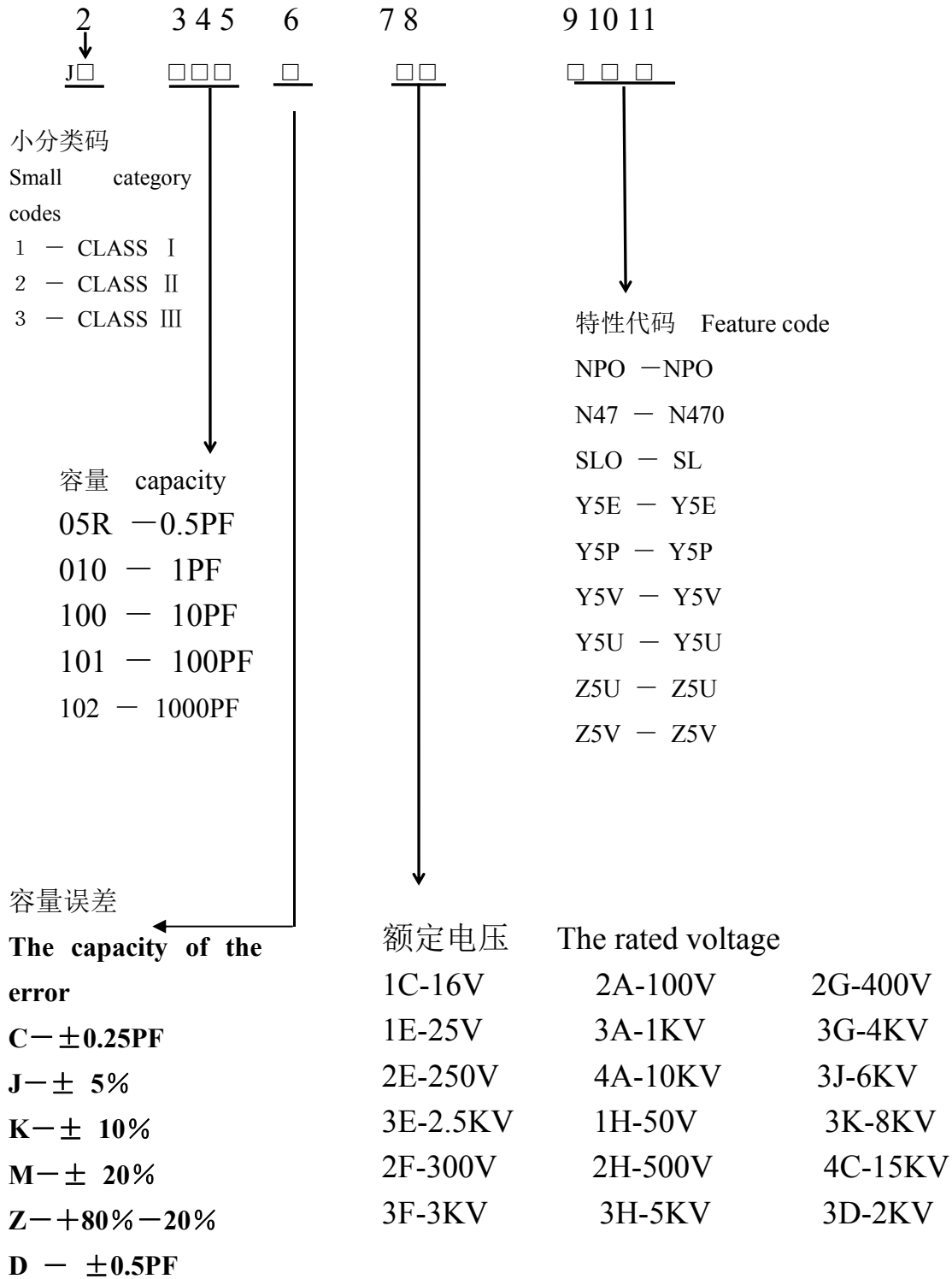

Porcelain capacitor shape specification:

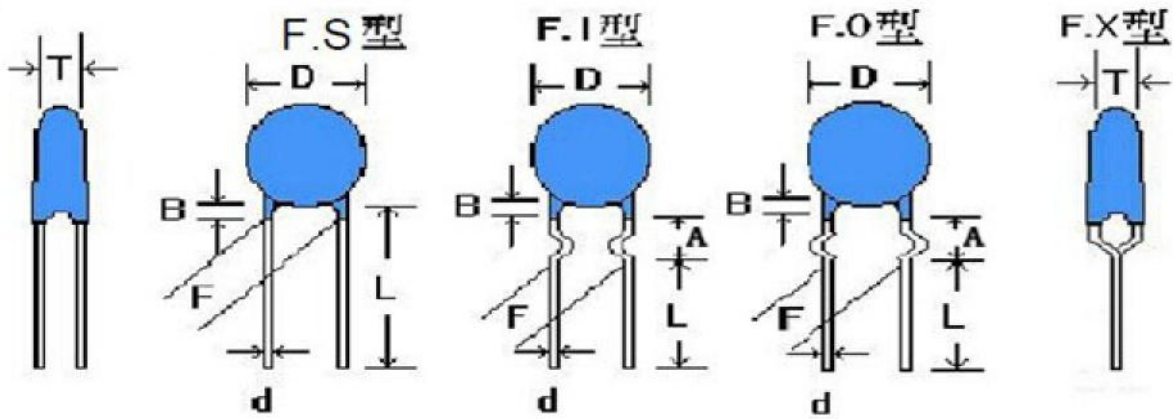

MODE	W.V	T m/m	d m/m	L m/m	F m/m	B m/m
F.S	12V - 100V	3 m/m	0.45 ± 0.05m/m	3 - 25m/m	2.50 m/m ± 0.8	2m/m
	500V - 1KV	3 m/m	0.48 ± 0.05m/m	3 - 25m/m	5.0 m/m ± 0.8	
	2KV - 3KV	4 m/m	0.55 ± 0.06m/m	3 - 25m/m	6.35 m/m ± 0.8	
	4KV - 8KV	6 m/m	0.55 ± 0.07m/m	3 - 25m/m	7.50 m/m ± 0.8	
	10KV - 15KV	8-10 m/m	0.55-0.80 ± 0.08m/m	3 - 25m/m	9.52-12.0m/m ± 0.8	
F.I	12V - 100V	3 m/m	0.48 ± 0.07m/m	3 - 25m/m	5.00 m/m ± 0.8	4m/m
	500V - 10KV	8 m/m	0.55 ± 0.08m/m	3 - 25m/m	9.50m/m ± 0.8	

- CLASS 1 TEMPERATURE COMPENSATING CAPACITOR
- CLASS 2 HIGH DIELECTRIC CONSTANT CAPACITOR
- CLASS 3 SEMICONDUCTIVE CAPACITOR
- CLASS 1.2. HIGH VOLTAGE CERAMIC CAPACITOR
- CLASS 1.2.3. APING SPECIFICATIONS

Packing Quantity

Packing	Safety	High Voltage	Ceramic
	Capacitor	Capacitor(Y1, Y2)	Capacitor DC
Bulk	1000PCS	1000PCS	2000PCS
Tape Ammo	2000PCS	1500PCS	2000PCS



TAPING SPECIFICATIONS

Taping (Radial)

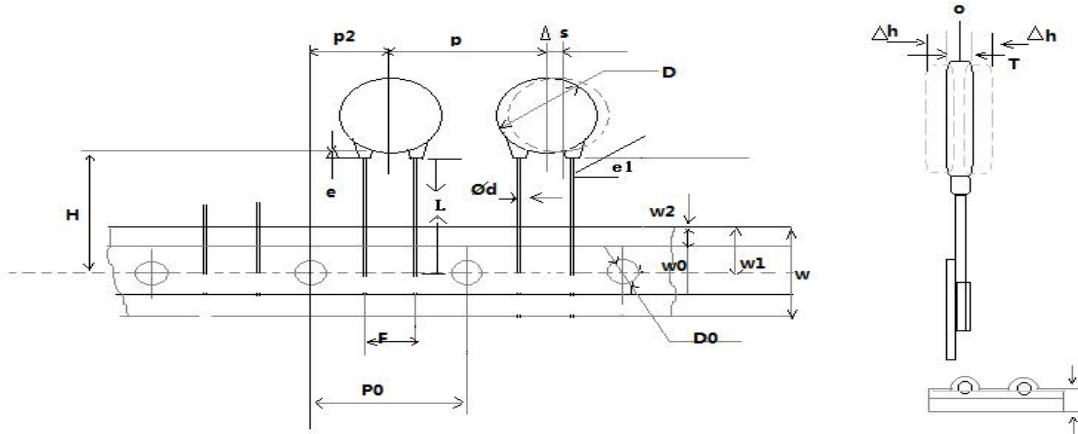

Item	Code	Dimensions (mm)	Item	Code	Dimensions (mm)
Taping Pitch	P	12.7±1.0	Lead Protrusion	l	+0.5~1.0
Guide Pitch	Po	12.7±1.0	Diameter of Feed Hole	Do	4.0±0.3
Lead Spacing	F	5.0±0.8 7.5±0.8	Diameter of Lead	d	0.55+0.06 -0.05
Feed Hole Position Capacitor Body	P2	6.35	Total Thickness of Tape	t	0.7±0.2
Feed Hole Position Capacitor Lead			Thickness of Capacitor Body	T	Differ in each product
Diameter Of ISO	D	See table of each series	Alignment to FR. Direction	Δ h	0±2.0
			Length of snapped Lead	L	17.0 +0 -1.0
Width Of Base Tape	W	18.0±0.5	Width of Hold-down Tape	Wo	12.5
Feed Hole Vertical Position	W1	9.0 +0.75 -0.05	Hold-down Tape Position	W2	1.5±1.5
Taping Height	For Straight	Ho	Coating Extention	e	3.0 以下
	For Crimp	H		e1	up to center of crimp

AMMO PACK

REEL

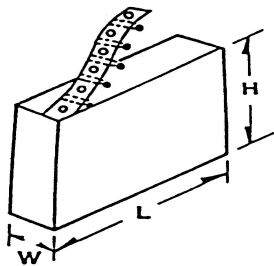

H = 234 ± 5 mm
L = 345 ± 5 mm
W = 50 ± 3 mm

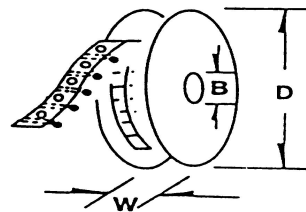

D ≅ 354(13.93)
B ≅ 21(.83')but
≅ 30(1.18")
W ≅ 55(2.16)

Acceptable to standard radial type cartridge.

Acceptable to standard radial type cartridge with a few extra accessories. Reeled axials are also acceptable to standard axial type cartridge with a few accessories.

■ HIGH VOLTAGE TEMPERATURE COMPENSATING CAPACITOR

Applications:

- Resonant circuit.
- High Q requirement.
- High stability Cap. Char.

Specifications:

Capacitance C	Range	1 PF ~ 680PF					measured at 1MHz±10%, 1.0 – 5.0 Vrms, 25°C	
	Tolerance	Code	C	D	J	K		
			±0.25 PF	±0.5 PF	± 5 %	± 10 %		
Quality Factor(Q)	C ≥ 30 PF	Q ≥ 1000						
	C < 30 PF	Q ≥ 400 + 20 × C						
Insulation Resistance (IR)		10000 MΩ min, measured at W.V.D.C, but not exceeding 500 VDC.						
Voltage	Working voltage (W.V.)	500V ~ 10KV DC						
	Test Condition			Test Voltage	Time	Current		
		W.V. = 500V		3.0 × W.V.	1 ~ 5 sec.	< 50 mA		
		W.V.= 1KV/2KV		2.0 × W.V.	1 ~ 5 sec.	< 50 mA		
		W.V.= 3KV/5KV		1.5 × W.V.	1 ~ 5 sec.	< 50 mA		
W.V. ≥ 6KV		1.2 × W.V.	1 ~ 5 sec.	< 50 mA				
Operating Temp. Range	Type Code	Temperature Coefficient (PPM / °C)			Temp. Range			
	NPO	± 0			- 25 °C to + 85 °C			
	SL	+350 ~ -1000						
	The reference temperature: 25 °C							

T. C.CHART

Applications:

- By-pass and coupling.
- Frequency discriminating circuits where Q and stability of Cap. Char. are not major importance.

■ **HIGH VOLTAGE** HIGH DIELECTRIC CONSTANT CAPACITOR

Applications:

- By-pass and coupling.
- Frequency discriminating circuits where Q and stability of Cap. Char. are not major importance.

Specifications:

Capacitance (C)	Range	100 PF ~ 47000PF					measured at 1KHz ± 10%, 1.0 – 5.0 Vrms, 25°C	
	Tolerance	Code	K	M	Z	P		
			± 10%	± 20%	+ 80%, - 20%	+ 100%, - 0%		
Dissipation Factor (D.F)	2.5% Max.	at 1KHz, 1.0 Vrms, 25°C for Y5E, Y5P,Z5U						
	5.0% Max.	at 1KHz, 1.0 Vrms, 25°C for Z5V						
Insulation Resistance (IR)	10000 MΩ min, measured at W.V.D.C, but not exceeding 500 VDC.							
Voltage	Working voltage (W.V.)	500V ~ 10KV DC						
	Test Condition			Test Voltage	Time	Current		
		W.V. = 500V		3.0 × W.V.	1 ~ 5 sec.	< 50 mA		
		W.V.= 1KV/2KV		2.0 × W.V.	1 ~ 5 sec.	< 50 mA		
		W.V.= 3KV/5KV		1.5 × W.V.	1 ~ 5 sec.	< 50 mA		
W.V. ≥ 6KV		1.2 × W.V.	1 ~ 5 sec.	< 50 mA				
Operating Temp. Range	Type Code	Max. Change in Cap.			Temp. Range			
	Y5E	± 4.7%						
	Y5P/X7R	± 10%			- 2 5 °C t o + 8 5 °C			
	Y5U	+ 22%, - 56%			- 2 5 °C t o + 8 5 °C			
	Y5V	+ 22%, - 82%			- 2 5 °C t o + 8 5 °C			
The reference temperature: 25 °C								