

深圳市拓展光电有限公司

SHENZHEN DEVELOPMENT PHOTOELECTRIC CO., LTD

SPECIFICATION

Model: 2835UVA365L-003

Date: 2020/12/19

NO: SZTZ-DS-UVA-004

Par NO: F.28.00001

承制方确认			
制作	审核	业务	品质

接受方确认			
工程制定	工程审核	采购	品质

2835UVA365L-003 Datasheet



The 2835 LED light source is a high-performance energy-saving device that can handle high heat and high drive current. Small size, high strength, is the ideal choice of LED nail lamp, LED mosquito lamp, LED lamp, curing, etc.

此款 2835 LED光源是一种高性能节能器件，可以处理高热量和高驱动电流。体积小、强度高，是LED指甲灯、LED蚊香灯、LED灯、固化灯等的理想选择。

The Purple LED light source with peak wavelength ranging from 365nm to 385nm.

紫外LED光源峰值波长为365nm ~ 385nm。

This part has a foot print that is compatible to most of the same size LED in the market today.

此器件的焊盘兼容当今市场上大部分相同大小的LED。

FEATURES/特点

- Available in 365-375nm, and 375-385nm color
有365-375nm和375-385nm两种颜色可供选择
- High luminous Intensity and high efficiency
发光强度高，效率高
- Compatible with reflow soldering process
兼容回流焊工艺
- Low thermal resistance/热阻低
- Long operation life/寿命长
- Wide viewing angle at 120°
120° 大发光角度
- Silicone encapsulation/硅胶封装
- Environmental friendly, RoHS compliance
材质环保，符合RoHS要求

APPLICATIONS/应用

- Nail lamp/指甲灯
- Curing light/光固化
- Mosquito lamp/诱蚊灯
- LED bulb/LED灯泡
- money detector/验钞
- The sterilization lamp/杀菌灯
- The stage lights/舞台灯光
- Clothing lights/服装灯光
- The scorpion lamp/蝎子灯

Note: The information in this document is subject to change without notice.

注：本文件中的信息如有变更，恕不另行通知。

PACKAGE DIMENSIONS 封装尺寸

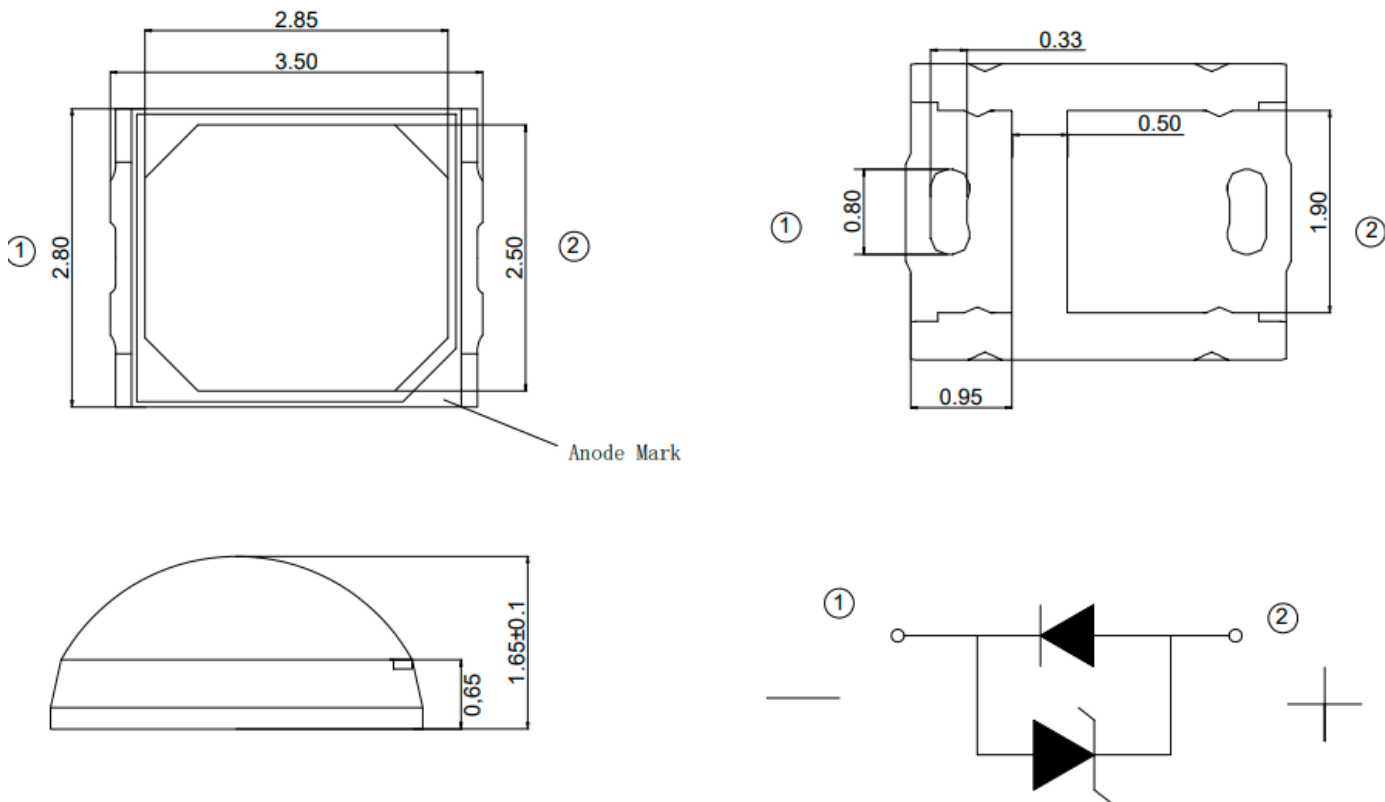

Recommended Solder Pad Design 推荐焊盘设计

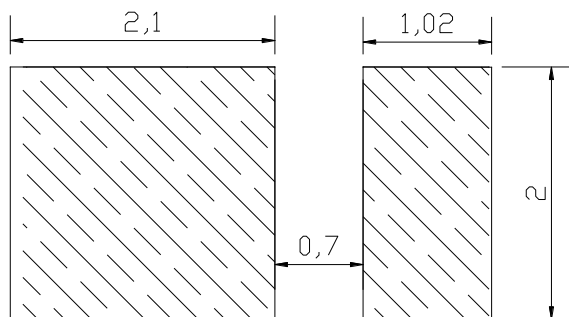

Notes/ 注:

1. All dimensions in millimeters. 所有尺寸单位为mm
2. Thickness tolerance of copper plate is ± 0.02 mm. 铜材料片厚度公差为 ± 0.02 mm
3. Thickness tolerance of product is ± 0.05 mm. 产品厚度公差为 ± 0.05 mm
4. Tolerance is ± 0.1 mm unless otherwise noted. 如未特别注明, 默认公差为 ± 0.1 mm

ABSOLUTE MAXIMUM RATINGS最大限定参数 (Ta=25°C)

Parameter 项目名称	Symbol 符号	Value 规格	Unit 单位
Forward current 正向电流	I_F	150	mA
Peak Forward Current 正向脉冲电流	I_{FP}	180	mA
Reverse Voltage 反向电压	V_R	5	V
Power Dissipation 消耗功率	P_d	500	mW
Operating Temperature 工作温度	T_{opr}	-40~+85	°C
Storage Temperature 储存温度	T_{stg}	-40~+100	°C
Soldering Temperature 焊接温度	T_{sld}	Reflow Soldering: 260°C for 10 seconds	
LED Junction Temperature 结温	T_j	110	°C

CHARACTERISTICS 光电参数(Ta=25°C)

Parameter 项目名称	Symbol 单位	Condition 条件	Min 最小值	Typ 中间值	Max 最大值	Unit 单位
Reverse Current反向漏电流	I_R	$V_R=5V$	--	--	3	uA
Forward Voltage正向电压	V_F	$I_F=150mA$	3.4	3.6	4.0	V
Viewing Angle发光角度	$2\theta_{1/2}$	$I_F=150mA$	--	120	--	deg.
Radiant Flux辐射通量	Φ_e	$I_F=150mA$	150	200	250	mW
peak wavelength峰值波长	λ_P	$I_F=150mA$	365	--	375	nm
Thermal Resistance热阻 (Junction to Solder Point)	R_{th-js}	$I_F=150mA$	--	15	--	°C/W

Notes/注:

1. Radiant Flux is measured with an accuracy of $\pm 5\%$. 辐射功率的测量精度为 $\pm 5\%$ 。
2. peak wavelength is measured with an accuracy of $\pm 5\%$. 峰值波长的测量精度为 $\pm 5\%$ 。
3. All measurements were made under the standardized environment of Tuozhan
所有的测量都是在拓展的标准环境下进行的

RELATIVE SPECTRAL POWER DISTRIBUTION 相对光谱功率分布 (T_j=25°C)

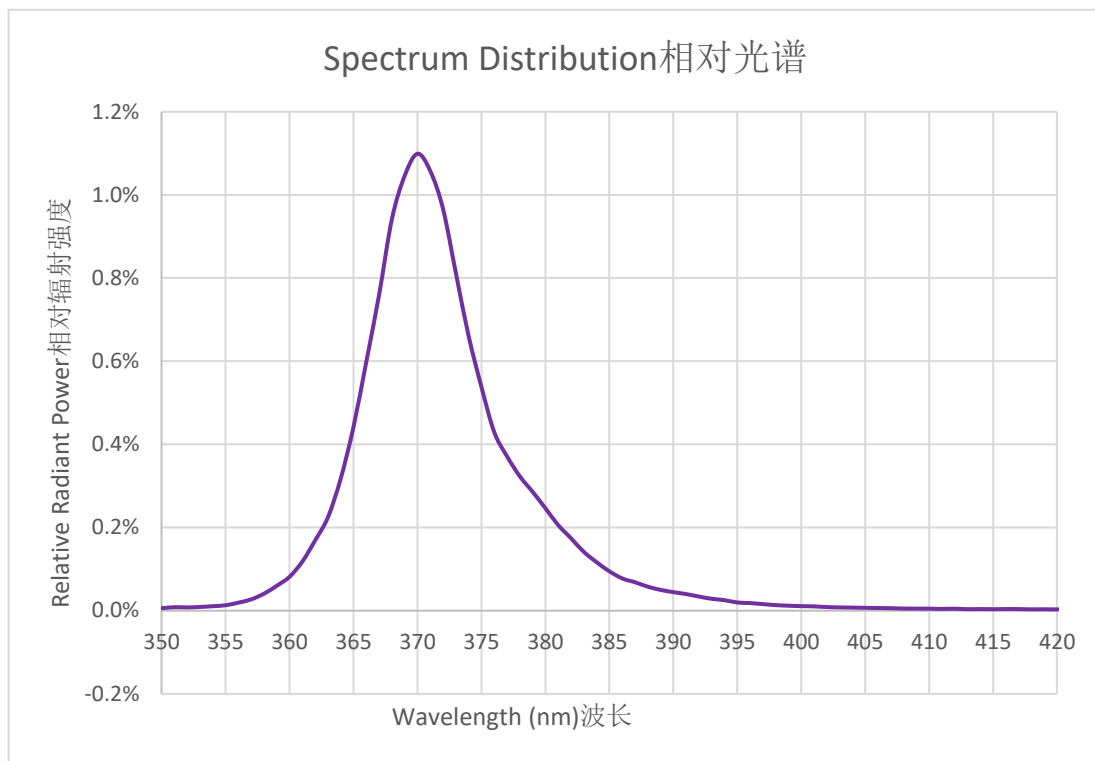

TYPICAL SPATIAL DISTRIBUTION 典型配光分布

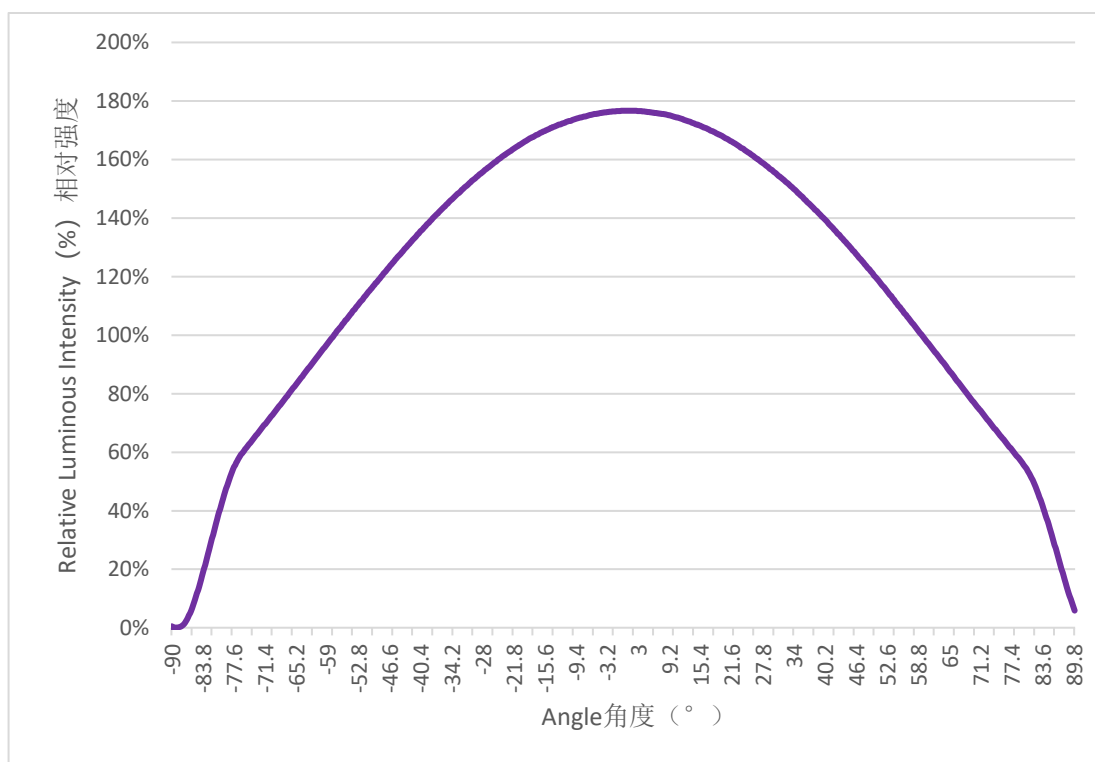

LUMINOUS INTENSITY VS. CURRENT 相对辐射通量VS电流 ($T_j=25^\circ\text{C}$)

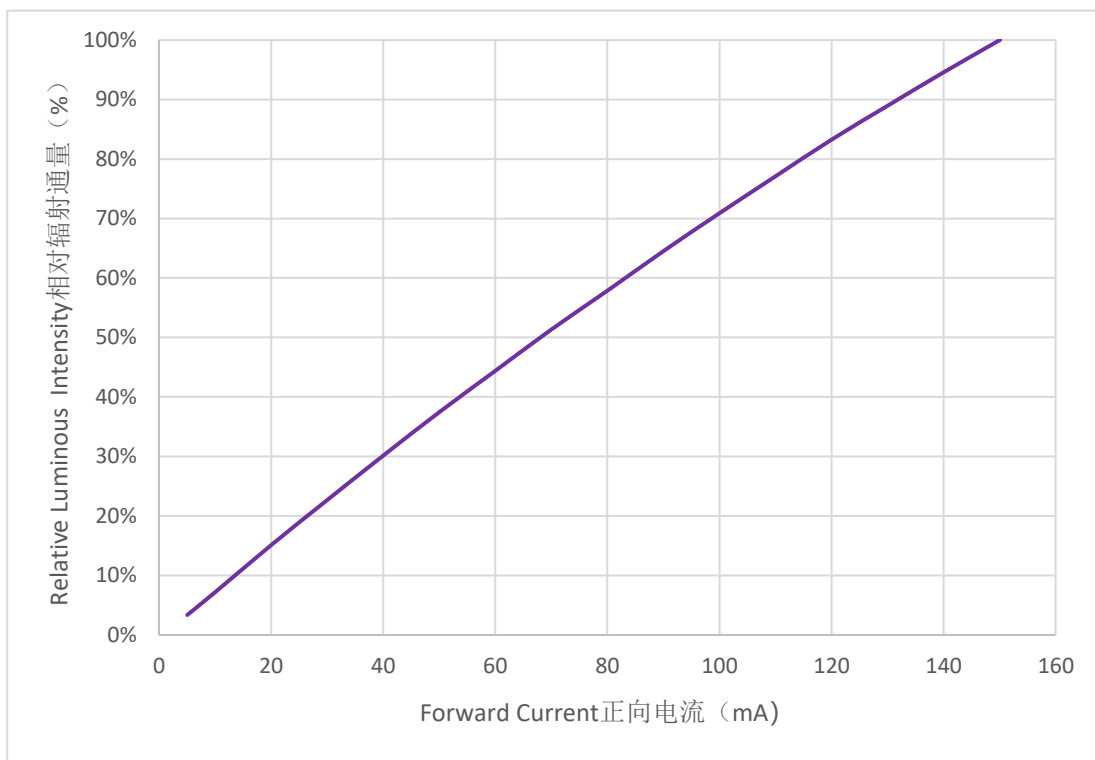

ELECTRICAL CHARACTERISTICS 电特性 ($T_j=25^\circ\text{C}$)

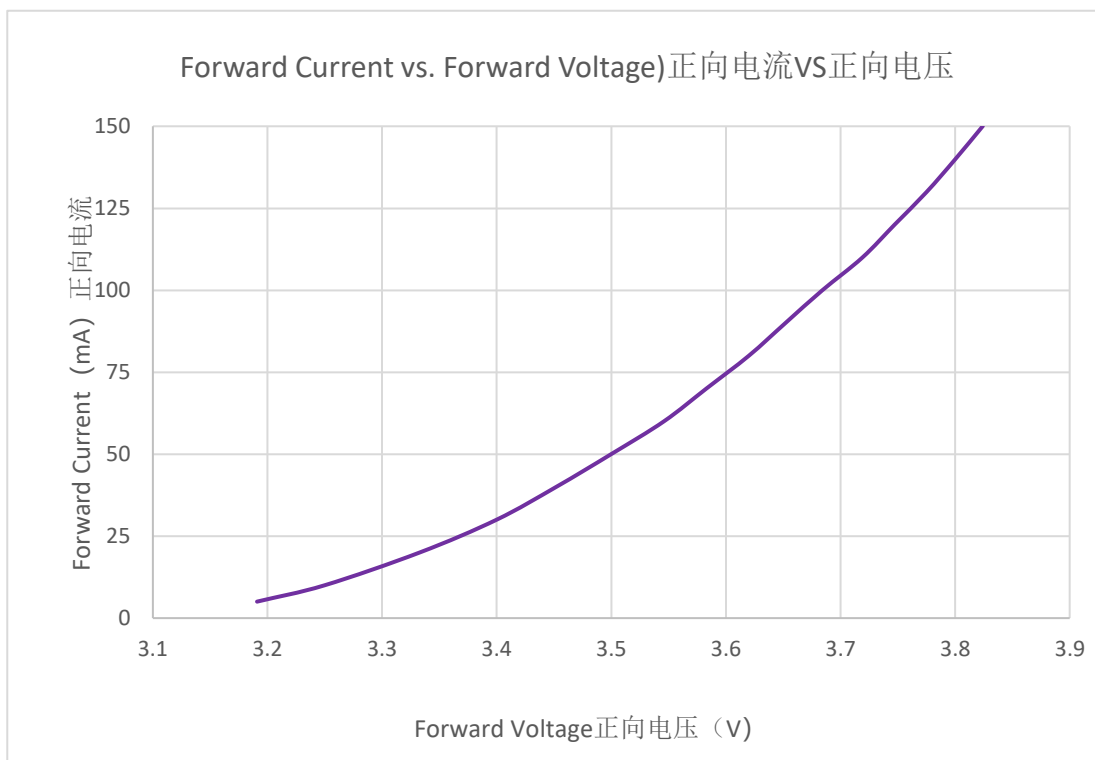

Temperature Vs. Peak Wavelength 温度与峰值波长的关系

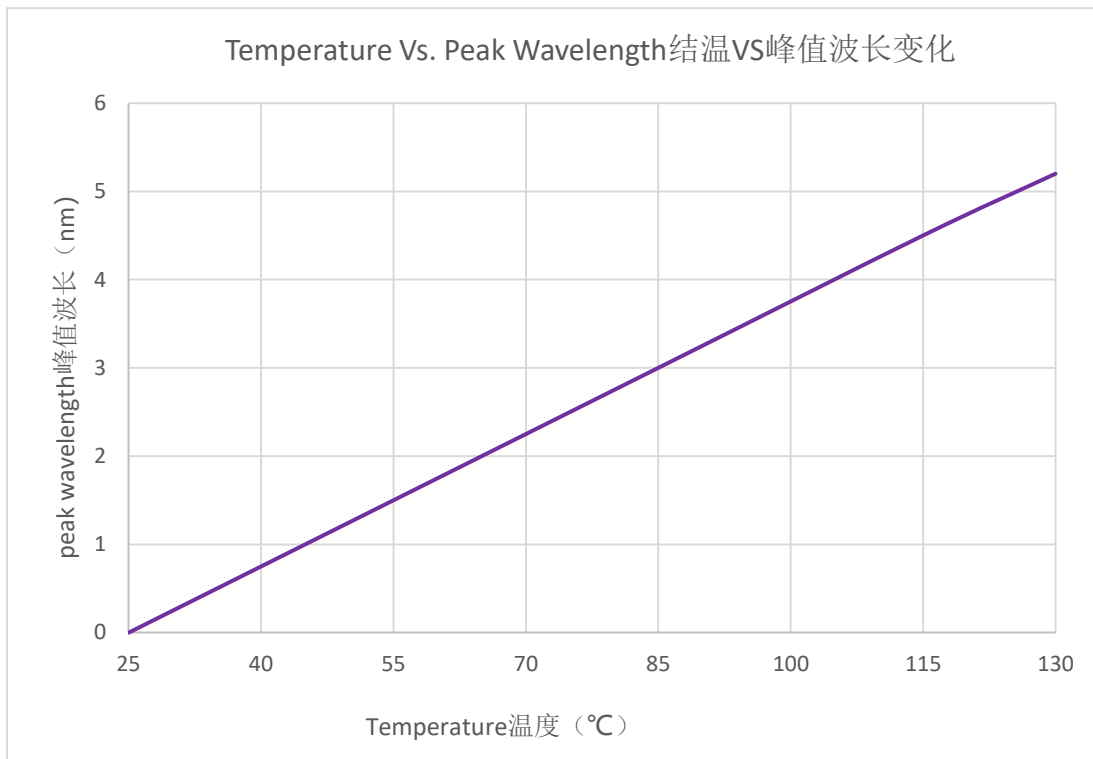

RELATIVE LUMINOUS Intensity VS. TEMPERATURE 相对辐射通量与结温的关系

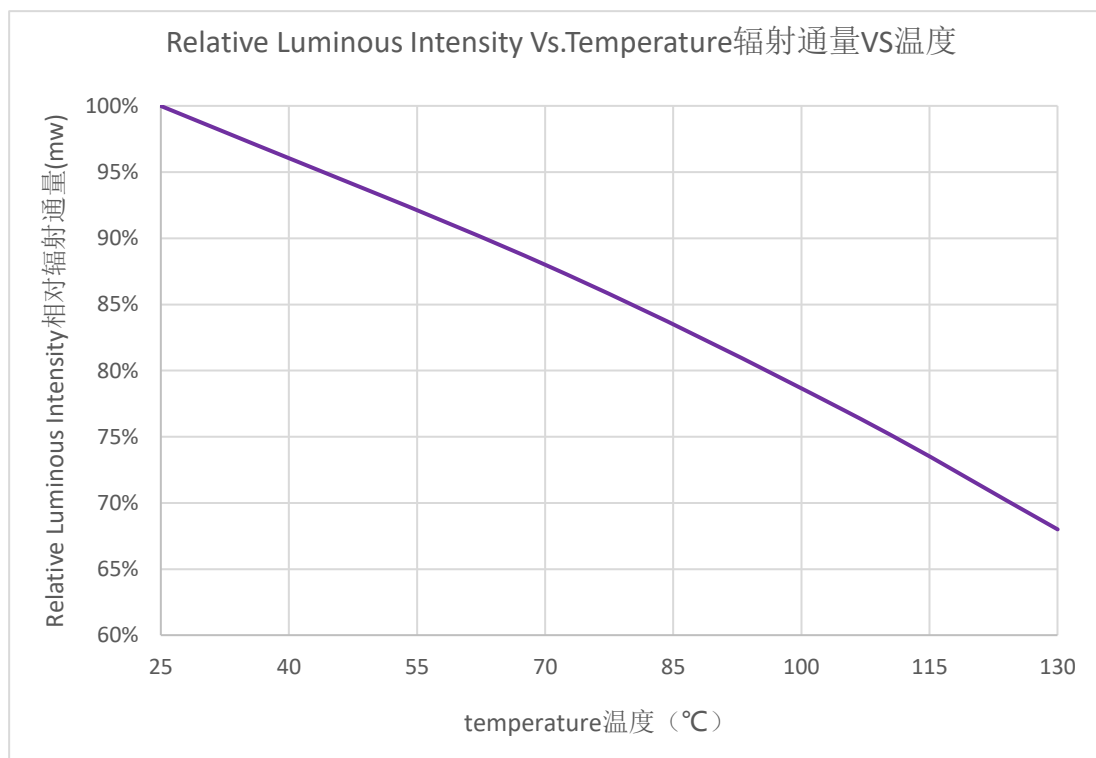

SORTING RANKS分光等级

(1) Luminous Intensity辐射功率 (Tj=25°C)

Part Number型号	Condition条件	Rank等级		Unit单位
2835UVA365L-003	150mA	Q50	Q60	mW
		150-160	160-170	
		Q70	Q80	
		170-180	180-190	
		Q90	R00	
		190-200	200-210	
		R10	R20	
		210-220	220-230	
		R30	R40	
		230-240	240-250	

(2) Forward Voltage正向电压 (Tj=25°C)

Rank等级	Condition条件	Min最小值	Max最大值	Unit单位
BC	150mA	3.4	3.6	V
BD		3.6	3.8	
BE		3.8	4.0	

(3) peak wavelength峰值波长 (Tj=25°C)

Part Number型号	Condition条件	Rank等级		Unit单位
2835UVA365L-003	150mA	SB	SC	nm
		365-370	370-375	
		SE	SF	
		375-380	380-385	

Notes/注:

1. 5% tolerance for radiant flux may be caused by measurement inaccuracy.

光辐射功率测量精度误差± 5%

2. Measurement Uncertainty of the Forward Voltage : ± 0.05V

正向电压测量误差:± 0.05

REFLOW SOLDERING CHARACTERISTICS 回流焊特性

For Reflow Process 回流焊制程:

Preheating 预热 : 140°C~160°C±5°C, within 2 minutes. 2分钟

Operation heating 作业加热 : 260°C(Max.) within 10 seconds.(Max)

260°C(最高) within 10 seconds.(最长)

Gradual Cooling (Avoid quenching). 逐渐冷却(避免淬火)

Lead solder 有铅焊接		Lead-free solder 无铅焊接	
Pre-heat 预热	120-150°C	Pre-heat 预热	150-200°C
Pre-heat time 预热时间	120 sec.Max.	Pre-heat time 预热实际那	120 sec.Max.
Peak Temperature 峰值温度	240°C Max.	Peak Temperature 峰值温度	260°C Max.
Soldering time condition 回流焊时间	10 sec.Max.	Soldering time condition 回流焊时间	10 sec.Max.

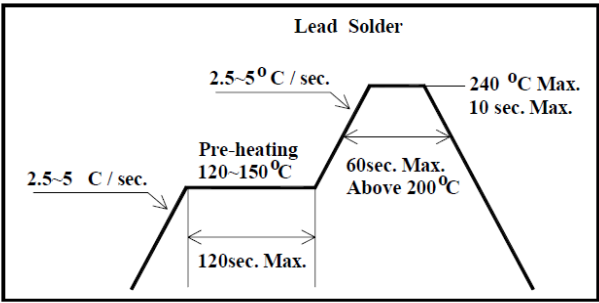
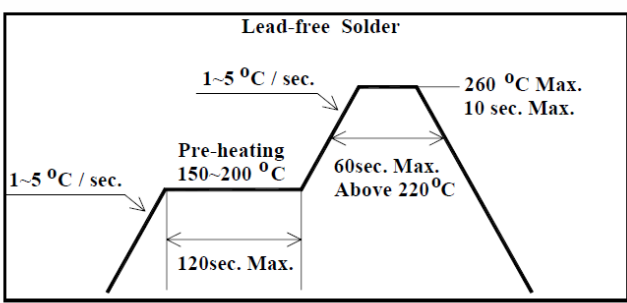
 <p>Lead Solder</p> <p>2.5-5 °C / sec.</p> <p>240 °C Max. 10 sec. Max.</p> <p>Pre-heating 120-150 °C</p> <p>60sec. Max. Above 200 °C</p> <p>2.5-5 C / sec.</p> <p>120sec. Max.</p>	 <p>Lead-free Solder</p> <p>1-5 °C / sec.</p> <p>260 °C Max. 10 sec. Max.</p> <p>Pre-heating 150-200 °C</p> <p>60sec. Max. Above 220 °C</p> <p>1-5 °C / sec.</p> <p>120sec. Max.</p>
----------------------------------------------------------------------------------------------------------------------------------------------------------------------------------------------------------------------------------------------------------------------------	--------------------------------------------------------------------------------------------------------------------------------------------------------------------------------------------------------------------------------------------------------------------------------

Notes注:

The encapsulated material of the LEDs is silicone . Therefore the LEDs have a soft surface on the top of package. The pressure to the top surface will be influence to the reliability of the LEDs. Precautions should be taken to avoid the strong pressure on the encapsulated part. So when using the picking up nozzle, the pressure on the silicone resin should be proper.

由于LED的封装材料是硅胶，led封装顶部表面是柔软的，顶部表面的压力会影响led的可靠性。应采取预防措施，以避免密封部件受到强大的压力。因此，在使用吸嘴时，应使硅胶表面的压力适中。

Reliability Test Items 可靠性测试项目

Test Items 测试项目	Test Duration 测试时长	Number of Damaged 不良数
Steady State Operating Life of High Temperature (HTOL) $T_s=85^{\circ}\text{C}$, $I_F=\text{Max}$ 高温点亮稳态老化 $T_s=85^{\circ}\text{C}$, $I_F=\text{最大值}$	1000hrs	0/20
Steady State Operating Life of Low Temperature (LTOL) $T_a=-40^{\circ}\text{C}$, $I_F=\text{Max}$ 低温点亮稳态老化 $T_s=85^{\circ}\text{C}$, $I_F=\text{最大值}$	1000hrs	0/20
Pulse Wet Operating Life of High Temperature (PWHTOL) 高温高湿通断电老化 $60^{\circ}\text{C}/90\%\text{RH}$, $I_F30\text{mins ON}/30\text{min OFF}$	500hrs	0/20
High Temperature Storage (HTS) 高温存储 100°C	1000hrs	0/20
Low Temperature Storage (LTS) 低温存储 -40°C	1000hrs	0/20
Thermal Shock (TS) $-45^{\circ}\text{C}\sim 125^{\circ}\text{C}$ 30min dwell 20sec transfer 冷热冲击 -45°C 30min $\sim 125^{\circ}\text{C}$ 30min, 转换时间20秒	300cycles	0/20
Solder Resistance (SR) 265°C , 3X MSL 阻焊测试 (3遍潮气敏感度试验后)	5sec	0/20
Solder Ability (SA) 245°C 5sec, 95% coverage 可焊性 95%覆盖	5sec	0/11
Mechanical Shock (MS) 1500G 0.5msec pulse shock 机械冲击(MS) 1500G 0.5毫秒脉冲冲击	Each6 axis	0/6
Random Vibration (RV) 随机振动 6G RMS, 10-2000Hz, 10min	Per axis	0/6
Variable Vibration Frequency (VVF) 10-2000-10Hz, log or linear sweep rate, 20G for 1 min, 1.5mm each apply 3x per axis over 变频振动(VVF) 10-2000-10Hz, 对数或线性扫频, 20G, 1分钟, 1.5mm, 每轴3遍以上	6hrs	0/6
Salt Spread (SS) 35°C , 30g/m ² /day 盐雾试验 35°C ,30克/平方米/天	48hrs	0/11

Item 项目	Symbol 符号	Test Condition 测试条件	Criteria for Judgment 判定标准	
			Min. 最小	Max. 最大
Forward Voltage 正向电压	V_F	$I_F=\text{Typical Current}$ 典型电流		U.S.L x1.1
Luminous Intensity 光功率	mW	$I_F=\text{Typical Current}$	L.S.L x0.7	
peak wavelength 峰值波长	nm	$I_F=\text{Typical Current}$		U.S.L x1.1

PRECAUTION FOR USE 使用注意事项

(1) This device should not be used in any type of fluid such as water, oil, organic solvent, etc. When washing is required, IPA should be used.

本器件不得用于水、油、有机溶剂等任何流体中。如需清洁，请使用异丙醇进行清洗。

(2) When the LEDs are illuminating, operating current should be decided after considering the ambient maximum temperature.

当LED发光工作时，应根据环境最高温度来确定工作电流。

(3) LEDs must be stored to maintain a clean atmosphere. If the LEDs are stored for 3 months or more after being shipped from TuoZhan, a sealed container with a nitrogen atmosphere should be used for storage.

LED储存环境须保持清洁。如果LED从拓展发货后需储存3个月或更长时间，则应使用氮气柜进行储存。

(4) The LEDs must be used within seven days after opening the moisture proof packing. Repack unused Products with anti-moisture packing, fold to close any opening and then store in a dry place.

LED须在打开防潮包装后七天内使用。用防潮包装重新包装未使用的产品，折叠以封住开口，然后存放在干燥的地方。

(5) The appearance and specifications of the product may be modified for improvement without notice.

产品外观及规格如有改进，恕不另行通知。

(6) This LED is sensitive to the static electricity and surge. It is recommended to use a wrist Band or anti-electrostatic glove when handling the LEDs.

LED对静电和浪涌很敏感。在处理LED时，建议使用防静电腕带或防静电手套。

(7) On manual soldering, a solder tip must be needed as grounded for usage. If over voltage which exceeds the absolute maximum rating is applied to LEDs, it will cause damage LEDs and result in destruction. Damaged LEDs will show some unusual characteristics such as leak current remarkably increase, turn-on voltage becomes lower and the LEDs get unlighted at low current.

手工焊接时，焊接头必须接地。如果对led施加超过绝对最大额定值的过电压，会对led造成损坏。损坏的led会出现一些不寻常的特性，如漏电流明显增加，接通电压降低，低电流时led不亮。

(8) Warm prompt "The UV damage eyes, Do not stare at the light source, And don't shine a light into someone's eyes"

温馨提示：“UV伤眼！不要盯着光源看，也不要光源照射别人的眼睛！”

