

Description

This 25-bit 1:1 or 14-bit 1:2 configurable registered buffer is designed for 1.7-V to 1.9-V VDD operation.

All clock and data inputs are compatible with the JEDEC standard for SSTL_18. The control inputs are LVCMOS. All outputs are 1.8-V CMOS drivers that have been optimized to drive the DDR-II DIMM load. IDT74SSTUBF32866B operates from a differential clock (CLK and $\overline{\text{CLK}}$). Data are registered at the crossing of CLK going high, and $\overline{\text{CLK}}$ going low.

The C0 input controls the pinout configuration of the 1:2 pinout from A configuration (when low) to B configuration (when high). The C1 input controls the pinout configuration from 25-bit 1:1 (when low) to 14-bit 1:2 (when high).

A - Pair Configuration (C01 = 0, C11 = 1 and C02 = 0, C12 = 1)

Parity that arrives one cycle after the data input to which it applies is checked on the PAR_IN of the first register. The second register produces PPO and QERR signals. The QERR of the first register is left floating. The valid error information is latched on the QERR output of the second register. If an error occurs QERR is latched low for two cycles or until RESET is low.

B - Single Configuration (C0 = 0, C1 = 0)

The device supports low-power standby operation. When the RESET input ($\overline{\text{RESET}}$) is low, the differential input receivers are disabled, and undriven (floating) data, clock and reference voltage (VREF) inputs are allowed. In addition, when $\overline{\text{RESET}}$ is low all registers are reset, and all outputs are forced low. The LVCMOS $\overline{\text{RESET}}$ and Cn inputs must always be held at a valid logic high or low level. To ensure defined outputs from the register before a stable clock has been supplied, $\overline{\text{RESET}}$ must be held in the low state during power up.

In the DDR-II RDIMM application, $\overline{\text{RESET}}$ is specified to be completely asynchronous with respect to CLK and $\overline{\text{CLK}}$. Therefore, no timing relationship can be guaranteed between the two. When entering reset, the register will be cleared and the outputs will be driven low quickly, relative to the time to disable the differential input receivers. However, when coming out of reset, the register will become active quickly, relative to the time to enable the differential input receivers. As long as the data inputs are low, and the clock is stable during the time from the low-to-high transition of $\overline{\text{RESET}}$ until the input receivers are fully enabled, the

design of the IDT74SSTUBF32866B must ensure that the outputs will remain low, thus ensuring no glitches on the output.

The device monitors both $\overline{\text{DCS}}$ and $\overline{\text{CSR}}$ inputs and will gate the Qn outputs from changing states when both $\overline{\text{DCS}}$ and $\overline{\text{CSR}}$ inputs are high. If either $\overline{\text{DCS}}$ and $\overline{\text{CSR}}$ input is low, the Qn outputs will function normally. The $\overline{\text{RESET}}$ input has priority over the $\overline{\text{DCS}}$ and $\overline{\text{CSR}}$ control and will force the outputs low. If the $\overline{\text{DCS}}$ -control functionality is not desired, then the $\overline{\text{CSR}}$ input can be hardwired to ground, in which case, the setup-time requirement for $\overline{\text{DCS}}$ would be the same as for the other D data inputs. Package options include 96-ball LFBGA (MO-205CC).

Features

- 25-bit 1:1 or 14-bit 1:2 registered buffer with parity check functionality
- Supports SSTL_18 JEDEC specification on data inputs and outputs
- Supports LVCMOS switching levels on C0, C1, and RESET inputs
- Low voltage operation: VDD = 1.7V to 1.9V
- Available in 96-ball LFBGA package

Applications

- DDR2 Memory Modules
- Provides complete DDR DIMM solution with ICS98ULPA877A or IDTCSPUA877A
- Ideal for DDR2 667 and 800

Functional Block Diagram for 1:1 Mode (Positive Logic)

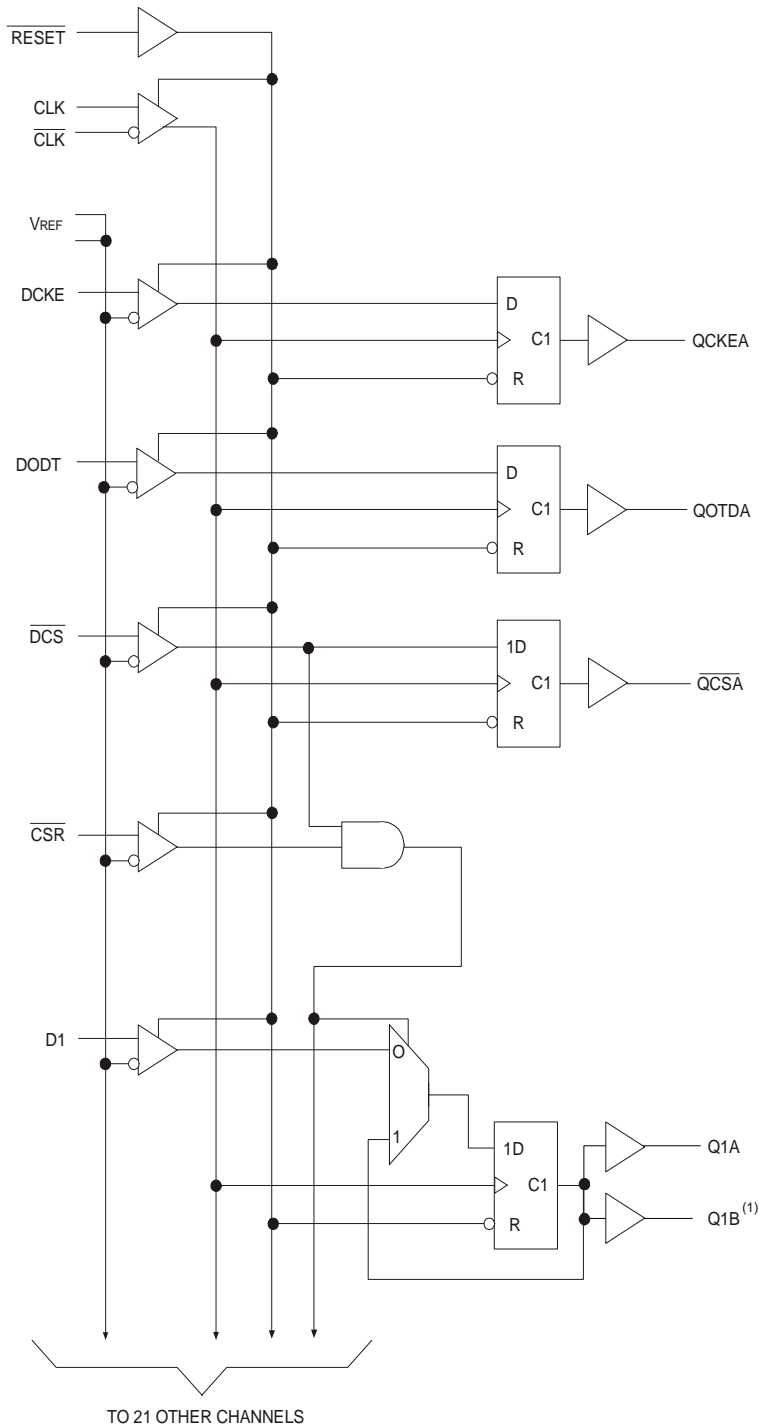

NOTE:
1. Disabled in 1:1 configuration.

Functional Block Diagram for 1:2 Mode (Positive Logic)

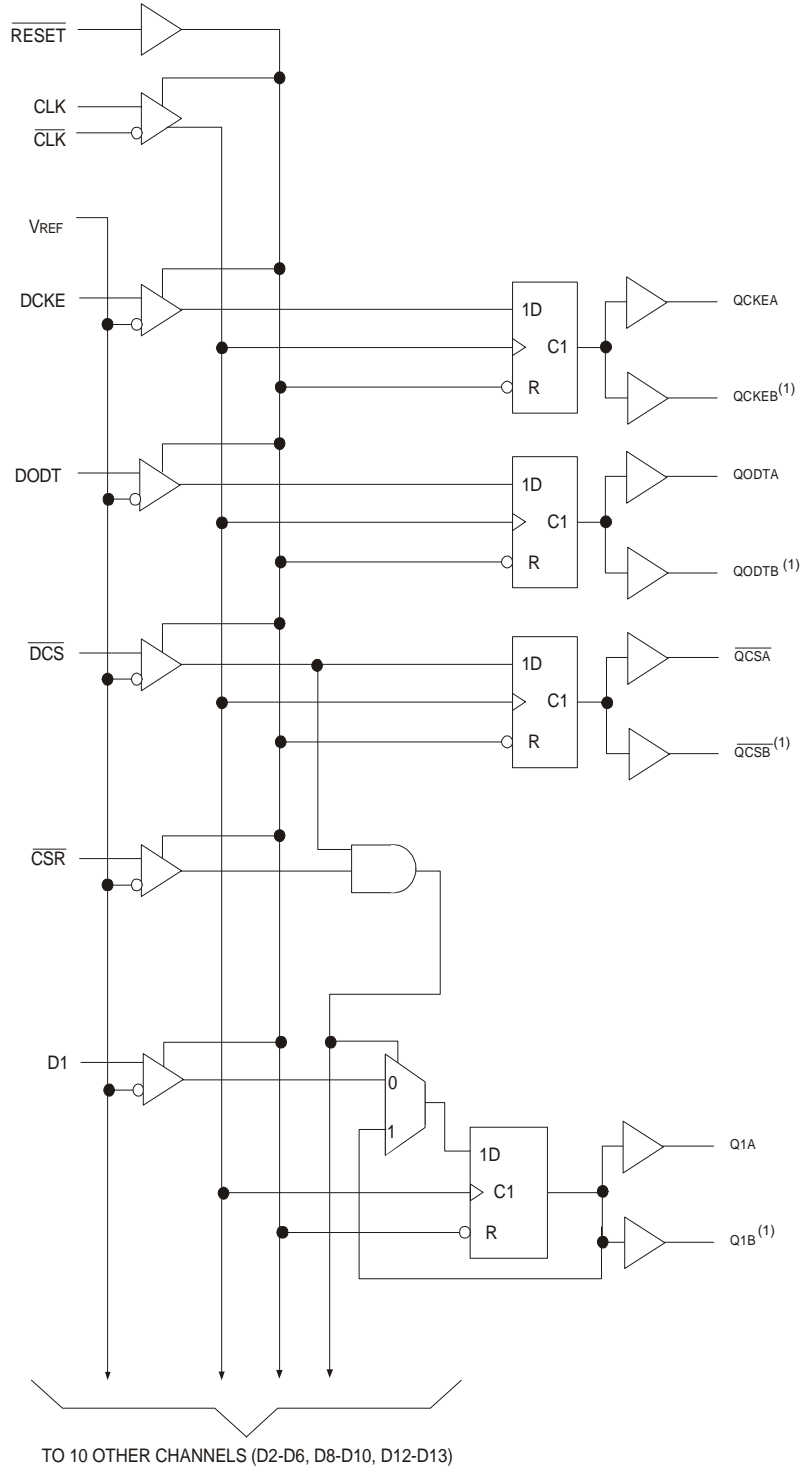

NOTE:
1. Disabled in 1:1 configuration.

Pin Configurations

14 BIT 1:2 REGISTERS

	1	2	3	4	5	6
A	DCKE	PPO	VREF	VDD	QCKEA	QCKEB
B	D2	NC	GND	GND	Q2A	Q2B
C	D3	NC	VDD	VDD	Q3A	Q3B
D	DODT	\overline{QERR}	GND	GND	QODTA	QODTB
E	D5	NC	VDD	VDD	Q5A	Q5B
F	D6	NC	GND	GND	Q6A	Q6B
G	PAR_IN	\overline{RESET}	VDD	VDD	C1	C0
H	CLK	\overline{DCS}	GND	GND	\overline{QCSA}	\overline{QCSB}
J	\overline{CLK}	\overline{CSR}	VDD	VDD	ZOH	ZoL
K	D8	NC	GND	GND	Q8A	Q8B
L	D9	NC	VDD	VDD	Q9A	Q9B
M	D10	NC	GND	GND	Q10A	Q10B
N	D11	NC	VDD	VDD	Q11A	Q11B
P	D12	NC	GND	GND	Q12A	Q12B
R	D13	NC	VDD	VDD	Q13A	Q13B
T	D14	NC	VREF	VDD	Q14A	Q14B

	1	2	3	4	5	6
A	D1	PPO	VREF	VDD	Q1A	Q1B
B	D2	NC	GND	GND	Q2A	Q2B
C	D3	NC	VDD	VDD	Q3A	Q3B
D	D4	\overline{QERR}	GND	GND	Q4A	Q4B
E	D5	NC	VDD	VDD	Q5A	Q5B
F	D6	NC	GND	GND	Q6A	Q6B
G	PAR_IN	\overline{RESET}	VDD	VDD	C1	C0
H	CLK	\overline{DCS}	GND	GND	\overline{QCSA}	\overline{QCSB}
J	\overline{CLK}	\overline{CSR}	VDD	VDD	ZoH	ZoL
K	D8	NC	GND	GND	Q8A	Q8B
L	D9	NC	VDD	VDD	Q9A	Q9B
M	D10	NC	GND	GND	Q10A	Q10B
N	DODT	NC	VDD	VDD	QODTA	QODTB
P	D12	NC	GND	GND	Q12A	Q12B
R	D13	NC	VDD	VDD	Q13A	Q13B
T	DCKE	NC	VREF	VDD	QCKEA	QCKEB

REGISTER A (C0 = 0, C1 = 1)

REGISTER B (C0 = 1, C1 = 1)

25 BIT 1:1 REGISTER

	1	2	3	4	5	6
A	DCKE	PPO	VREF	VDD	QCKE	NC
B	D2	D15	GND	GND	Q2	Q15
C	D3	D16	VDD	VDD	Q3	Q16
D	DODT	\overline{QERR}	GND	GND	QODT	NC
E	D5	D17	VDD	VDD	Q5	Q17
F	D6	D18	GND	GND	Q6	Q18
G	PAR_IN	\overline{RESET}	VDD	VDD	C1	C0
H	CLK	\overline{DCS}	GND	GND	\overline{QCS}	NC
J	\overline{CLK}	\overline{CSR}	VDD	VDD	ZOH	ZoL
K	D8	D19	GND	GND	Q8	Q19
L	D9	D20	VDD	VDD	Q9	Q20
M	D10	D21	GND	GND	Q10	Q21
N	D11	D22	VDD	VDD	Q11	Q22
P	D12	D23	GND	GND	Q12	Q23
R	D13	D24	VDD	VDD	Q13	Q24
T	D14	D25	VREF	VDD	Q14	Q25

C0 = 0, C1 = 0

96 Ball LFBGA Package Attributes

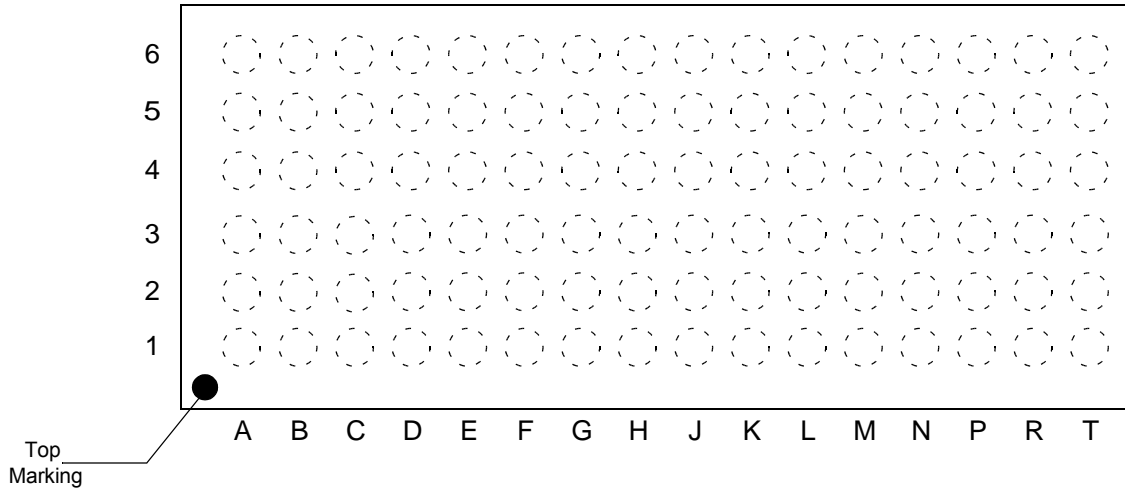

TOP VIEW

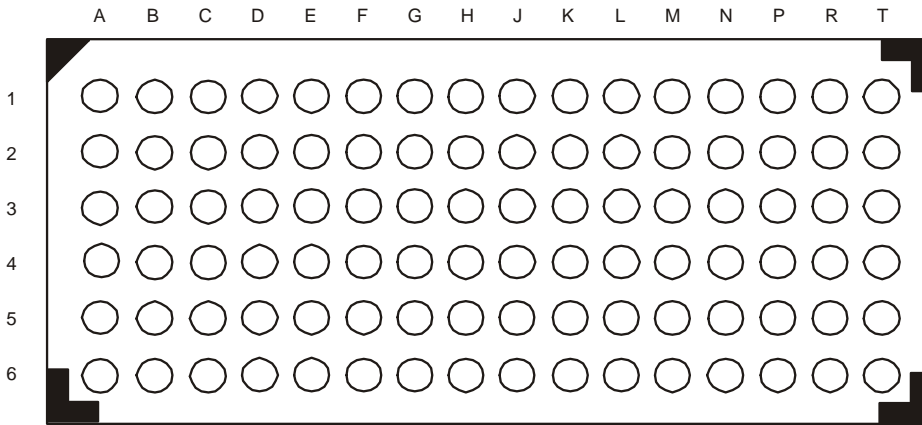

BOTTOM VIEW

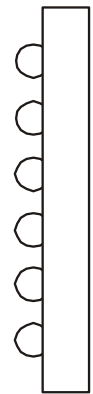

SIDE VIEW

Function Table

Inputs ¹						Outputs		
$\overline{\text{RESET}}$	$\overline{\text{DCS}}$	$\overline{\text{CSR}}$	CLK	$\overline{\text{CLK}}$	Dn, DODT, DCKE	Qn	$\overline{\text{QCS}}$	QODT, QCKE
H	L	L	↑	↓	L	L	L	L
H	L	L	↑	↓	H	H	L	H
H	L	L	L or H	L or H	X	Q_0^2	Q_0^2	Q_0^2
H	L	H	↑	↓	L	L	L	L
H	L	H	↑	↓	H	H	L	H
H	L	H	L or H	L or H	X	Q_0^2	Q_0^2	Q_0^2
H	H	L	↑	↓	L	L	H	L
H	H	L	↑	↓	H	H	H	H
H	H	L	L or H	L or H	X	Q_0^2	Q_0^2	Q_0^2
H	H	H	↑	↓	L	Q_0^2	H	L
H	H	H	↑	↓	H	Q_0^2	H	H
H	H	H	L or H	L or H	X	Q_0^2	Q_0^2	Q_0^2
L	X or Floating	X or Floating	X or Floating	X or Floating	X or Floating	L	L	L

1 H = HIGH Voltage Level

L = LOW Voltage Level

X = Don't Care

↑ = LOW to HIGH

↓ = HIGH to LOW

2 Output level before the indicated steady-state conditions were established.

Parity and Standby Function Table

Inputs ¹							Outputs	
$\overline{\text{RESET}}$	$\overline{\text{DCS}}$	$\overline{\text{CSR}}$	CLK	$\overline{\text{CLK}}$	Σ of Inputs = H (D1 - D25)	PAR_IN ²	$\overline{\text{PPO}}$	$\overline{\text{QERR}}$ ³
H	L	X	↑	↓	Even	L	L	H
H	L	X	↑	↓	Odd	L	H	L
H	L	X	↑	↓	Even	H	H	L
H	L	X	↑	↓	Odd	H	L	H
H	X	L	↑	↓	Even	L	L	H
H	X	L	↑	↓	Odd	L	H	L
H	X	L	↑	↓	Even	H	H	L
H	X	L	↑	↓	Odd	H	L	H
H	H	H	↑	↓	X	X	PPO ₀	$\overline{\text{QERR}}_0$
H	X	X	L or H	L or H	X	X	PPO ₀	$\overline{\text{QERR}}_0$
L	X or Floating	X or Floating	X or Floating	X or Floating	X or Floating	X or Floating	L	H

1 H = HIGH Voltage Level

L = LOW Voltage Level

X = Don't Care

↑ = LOW to HIGH

↓ = HIGH to LOW

Data Inputs = D2, D3, D5, D6, D8 - D25 when C0 = 0 and C1 = 0.

Data Inputs = D2, D3, D5, D6, D8 - D14 when C0 = 0 and C1 = 1.

Data Inputs = D1 - D6, D8 - D10, D12, D13 when C0 = 1 and C1 = 1.

2 PAR_IN arrives one clock cycle after the data to which it applies when C0 = 0, and two clock cycles when C0 = 1.

3 This transition assumes $\overline{\text{QERR}}$ is HIGH at the crossing of CLK going HIGH and $\overline{\text{CLK}}$ going LOW. If $\overline{\text{QERR}}$ is LOW, it stays latched LOW for two clock cycles or until $\overline{\text{RESET}}$ is driven LOW.

Logic Diagram (1:1)



Parity Logic Diagram for 1:1 Register Configuration (Positive Logic); C0 = 0, C1 = 0

Logic Diagram (1:2)

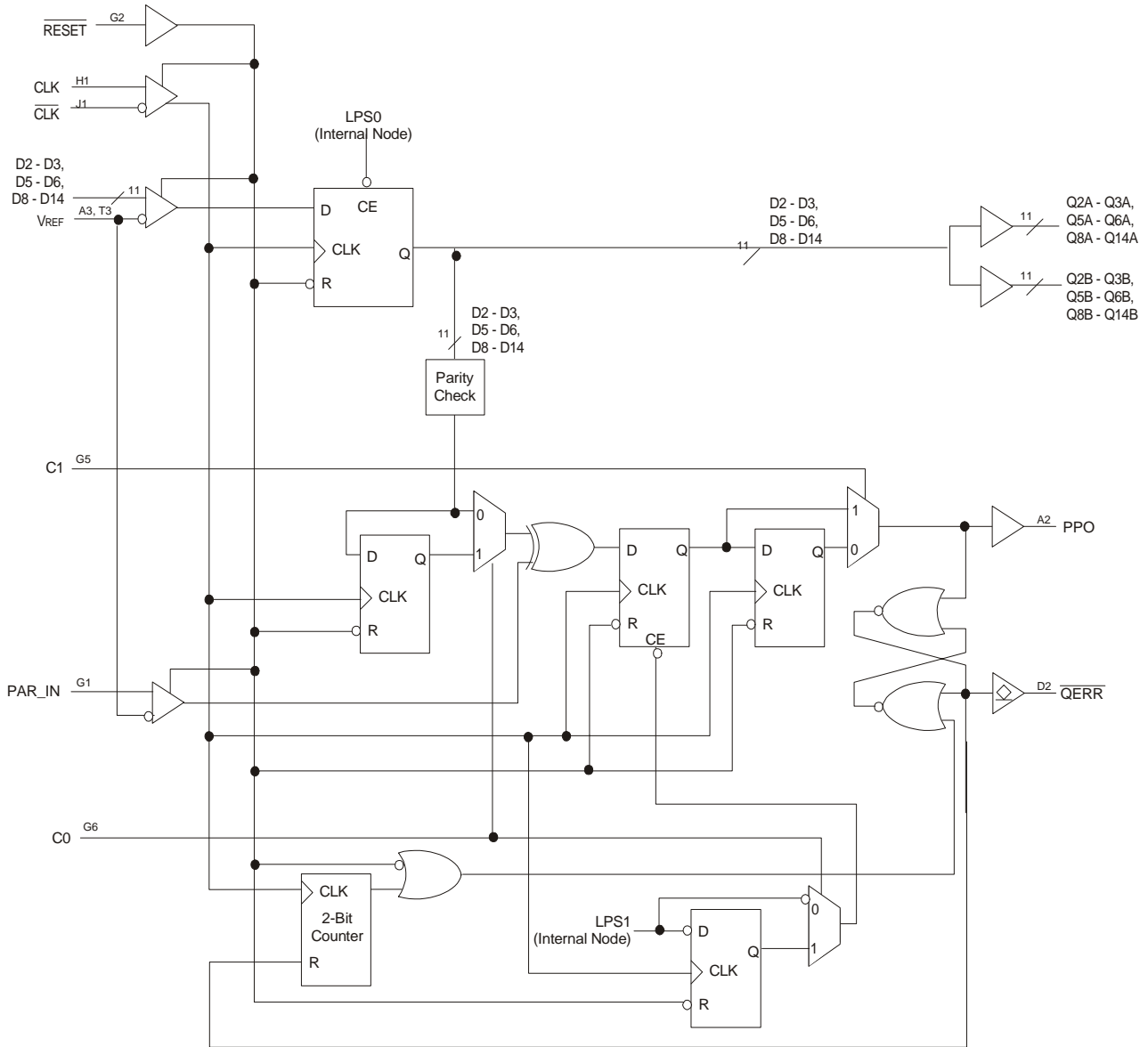

Parity Logic Diagram for 1:2 Register - A Configuration (Positive Logic);

C0 = 0, C1 = 1

Logic Diagram (1:2)

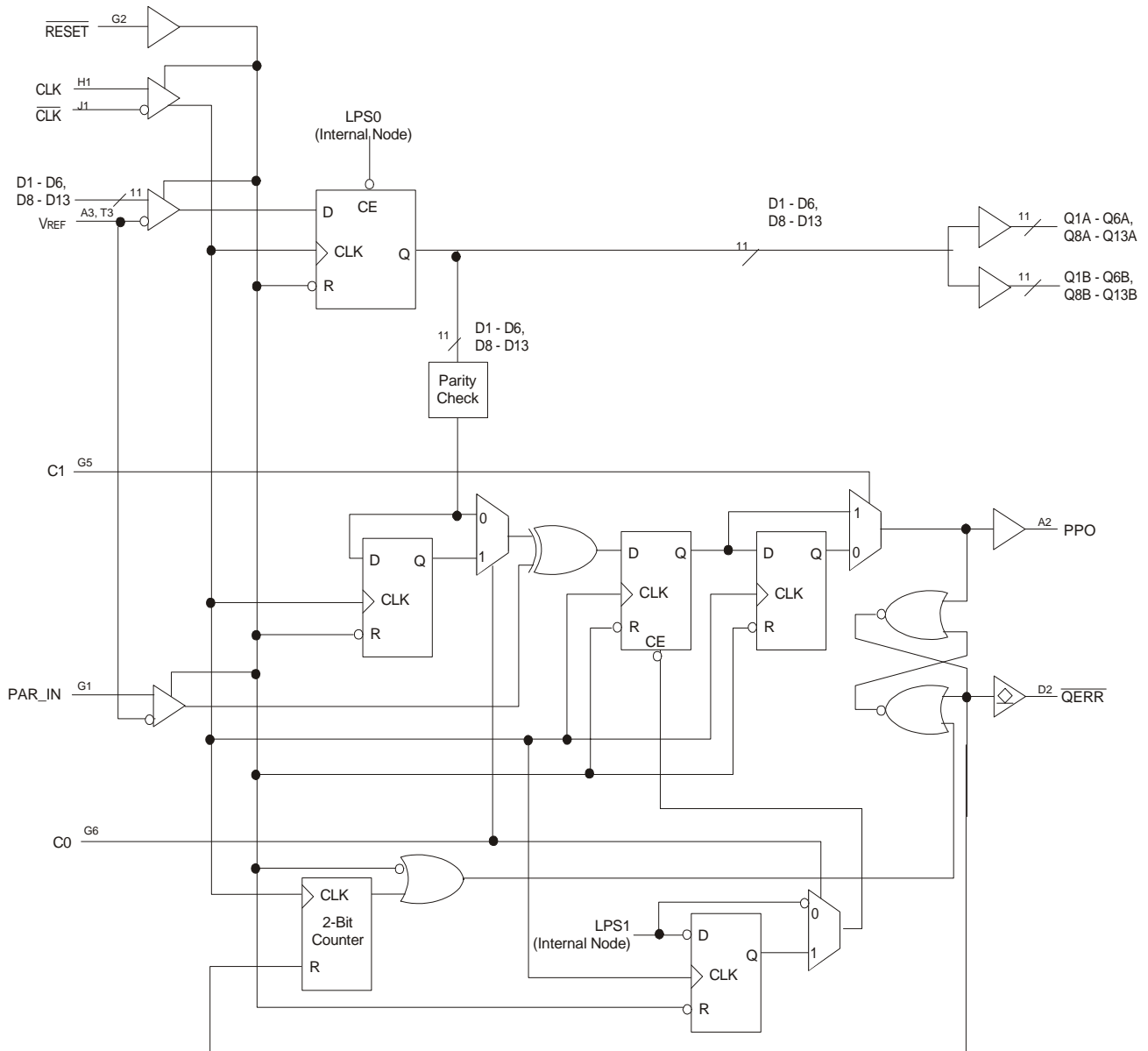

Parity Logic Diagram for 1:2 Register - B Configuration (Positive Logic);

C0 = 1, C1 = 1

Absolute Maximum Ratings

Stresses greater than those listed under ABSOLUTE MAXIMUM RATINGS may cause permanent damage to the device. This is a stress rating only and functional operation of the device at these or any other conditions above those indicated in the operational sections of this specification is not implied. Exposure to absolute maximum rating conditions for extended periods may affect reliability.

Item		Rating
Supply Voltage, VDD		-0.5V to 2.5V
Input Voltage Range, Vi ¹		-0.5V to 2.5V
Output Voltage Range, Vo ^{1,2}		-0.5V to VDD + 0.5V
Input Clamp Current, IiK		±50mA
Output Clamp Current, IoK		±50mA
Continuous Output Clamp Current, Io		±50mA
Continuous Current through each VDD or GND		±100mA
Package Thermal Impedance (θ_{ja}) ³	0m/s Airflow	70.9° C/W
	1m/s Airflow	65° C/W
Storage Temperature, TSTG		-65 to +150° C

1 The input and output negative voltage ratings may be exceeded if the ratings of the I/P and O/P clamp current are observed.

2 This current will flow only when the output is in the high state level $V_O > V_{DDQ}$.

3 The package thermal impedance is calculated in accordance with JESD 51.

Terminal Functions

Terminal Name	Electrical Characteristics	Description
GND	Ground Input	Ground
VDD	1.8V nominal	Power Supply Voltage
VREF	0.9V nominal	Input Reference Clock
ZOH	Input	Reserved for future use
ZOL	Input	Reserved for future use
CLK	Differential Input	Positive Master Clock Input
$\overline{\text{CLK}}$	Differential Input	Negative Master Clock Input
C0, C1	LVC MOS Input	Configuration Control Inputs
$\overline{\text{RESET}}$	LVC MOS Input	Asynchronous Reset Input. Resets registers and disables VREF data and clock differential-input receivers.
$\overline{\text{CSR}}, \overline{\text{DCS}}$	SSTL_18 Input	Chip Select Inputs. Disables outputs D1 - D24 output switching when both inputs are HIGH.
D1 - D25	SSTL_18 Input	Data Input. Clocked in on the crossing of the rising edge of CLK and the falling edge of $\overline{\text{CLK}}$.
DODT	SSTL_18 Input	The outputs of this register bit will not be suspended by the $\overline{\text{DCS}}$ and $\overline{\text{CSR}}$ controls
DCKE	SSTL_18 Input	The outputs of this register bit will not be suspended by the $\overline{\text{DCS}}$ and $\overline{\text{CSR}}$ controls
Q1 - Q25	1.8V CMOS	Data Outputs that are suspended by the $\overline{\text{DCS}}$ and $\overline{\text{CSR}}$ controls
$\overline{\text{QCS}}$	1.8V CMOS	Data Output that will not be suspended by the $\overline{\text{DCS}}$ and $\overline{\text{CSR}}$ controls
QODT	1.8V CMOS	Data Output that will not be suspended by the $\overline{\text{DCS}}$ and $\overline{\text{CSR}}$ controls
QCKE	1.8V CMOS	Data Output that will not be suspended by the $\overline{\text{DCS}}$ and $\overline{\text{CSR}}$ controls
PPO	1.8V CMOS	Partial Parity Output. Indicates off parity of D1 - D25
PAR_IN	SSTL_18 Input	Parity Input arrives one cycle after corresponding data input
$\overline{\text{QERR}}$	Open Drain Output	Output Error bit, generated one cycle after the corresponding data output

Operating Characteristics

The $\overline{\text{RESET}}$ and Cn inputs of the device must be held at valid levels (not floating) to ensure proper device operation. The differential inputs must not be floating unless $\overline{\text{RESET}}$ is LOW.

Symbol	Parameter		Min.	Typ.	Max.	Units
VDDQ	I/O Supply Voltage		1.7		1.9	V
VREF	Reference Voltage		$0.49 * VDD$	$0.5 * VDD$	$0.51 * VDD$	V
VTT	Termination Voltage		$VREF - 0.04$	VREF	$VREF + 0.04$	V
Vi	Input Voltage		0		VDD	V
VIH	AC High-Level Input Voltage	Data, $\overline{\text{CSR}}$, and PAR_IN inputs	$VREF + 0.25$			V
VIL	AC Low-Level Input Voltage				$VREF - 0.25$	
VIH	DC High-Level Input Voltage		$VREF + 0.125$			
VIL	DC Low-Level Input Voltage				$VREF - 0.125$	
VIH	High-Level Input Voltage	$\overline{\text{RESET}}$, C0, C1	$0.65 * VDDQ$			V
VIL	Low-Level Input Voltage				$0.35 * VDDQ$	
VICR	Common Mode Input Range	CLK, $\overline{\text{CLK}}$	0.675		1.125	V
VID	Differential Input Voltage		600			mV
IOH	High-Level Output Current				-8	mA
IOL	Low-Level Output Current				8	
IERR $\overline{\text{OL}}$	$\overline{\text{QERR}}$ LOW Level Output Current		25			mA
TA	Operating Free-Air Temperature		0		+70	°C

DC Electrical Characteristics Over Operating Range

Following Conditions Apply Unless Otherwise Specified:

Operating Condition: $T_A = 0^{\circ}\text{C}$ to $+70^{\circ}\text{C}$, $V_{DD} = 1.7\text{V}$ to 1.9V .

Symbol	Parameter	Test Conditions	Min.	Typ.	Max.	Units
V_{IK}		$I_I = -18\text{mA}$			-1.2	V
V_{OH}	Output HIGH Voltage	$I_{OH} = -6\text{mA}$	1.2			V
V_{OL}	Output LOW Voltage	$I_{OL} = 6\text{mA}$			0.5	V
V_{ERROL}	\overline{QERR} Output LOW Voltage	$I_{ERROL} = 25\text{mA}$, $V_{DD} = 1.7\text{V}$			0.5	V
I_{IL}	All Inputs	$V_I = V_{DD}$ or GND; $V_{DD} = 1.9\text{V}$	-5		+5	μA
I_{DD}	Static Standby	$I_O = 0$, $V_{DD} = 1.9\text{V}$, $\overline{RESET} = \text{GND}$			100	μA
	Static Operating	$I_O = 0$, $V_{DD} = 1.9\text{V}$, $\overline{RESET} = V_{DD}$, $V_I = V_{IH(AC)}$ or $V_{IL(AC)}$, $\text{CLK} = \overline{\text{CLK}} = V_{IH(AC)}$ or $V_{IL(AC)}$			20	mA
$I_O = 0$, $V_{DD} = 1.9\text{V}$, $\overline{RESET} = V_{DD}$, $V_I = V_{IH(AC)}$ or $V_{IL(AC)}$, $\text{CLK} = V_{IH(AC)}$, $\overline{\text{CLK}} = V_{IL(AC)}$				100		
I_{DDD}	Dynamic Operating (clock only)	$I_O = 0$, $V_{DD} = 1.8\text{V}$, $\overline{RESET} = V_{DD}$, $V_I = V_{IH(AC)}$ or $V_{IL(AC)}$, CLK and $\overline{\text{CLK}}$ switching 50% duty cycle		210		$\mu\text{A}/\text{Clock MHz}$
	Dynamic Operating (per each data input)	$I_O = 0$, $V_{DD} = 1.8\text{V}$, $\overline{RESET} = V_{DD}$, $V_I = V_{IH(AC)}$ or $V_{IL(AC)}$, CLK and $\overline{\text{CLK}}$ switching 50% duty cycle. One data input switching at half clock frequency, 50% duty cycle.	1:1 mode		70	$\mu\text{A}/\text{Clock MHz}/\text{Data Input}$
			1:2 mode		120	
C_{IN}	Data Inputs	$V_I = V_{REF} \pm 350\text{mV}$	2		3	pF
	CLK and $\overline{\text{CLK}}$	$V_{ICR} = 1.25\text{V}$, $V_{IPP} = 360\text{mV}$	2		3	
	\overline{RESET}	$V_I = V_{DD}$ or GND		5		

Timing Requirements Over Recommended Operating Free-Air Temperature Range

Symbol	Parameter	VDD = 1.8V ± 0.1V		Units
		Min.	Max.	
fCLOCK	Clock Frequency		410	MHz
tW	Pulse Duration, CLK, $\overline{\text{CLK}}$ HIGH or LOW	1		ns
tACT ¹	Differential Inputs Active Time		10	ns
tINACT ²	Differential Inputs Inactive Time		15	ns
tSU	Setup Time	$\overline{\text{DCS}}$ before CLK \uparrow , $\overline{\text{CLK}}\downarrow$, $\overline{\text{CSR}}$ HIGH; $\overline{\text{CSR}}$ before CLK \uparrow , $\overline{\text{CLK}}\downarrow$, $\overline{\text{DCS}}$ HIGH	0.6	ns
		$\overline{\text{DCS}}$ before CLK \uparrow , $\overline{\text{CLK}}\downarrow$, $\overline{\text{CSR}}$ LOW	0.5	
		DODT, DOCKE, and data before CLK \uparrow , $\overline{\text{CLK}}\downarrow$	0.5	
		PAR_IN before CLK \uparrow , $\overline{\text{CLK}}\downarrow$	0.5	
tH	Hold Time	$\overline{\text{DCS}}$, DODT, DCKE, and data after CLK \uparrow , $\overline{\text{CLK}}\downarrow$	0.4	ns
		PAR_IN after CLK \uparrow , $\overline{\text{CLK}}\downarrow$	0.4	

1 VREF must be held at a valid input voltage level and data inputs must be held at valid logic levels for a minimum time of tACT(max) after RESET is taken HIGH.

2 VREF, data, and clock inputs must be held at a valid input voltage levels (not floating) for a minimum time of tINACT(max) after RESET is taken LOW.

Switching Characteristics Over Recommended Free Air Operating Range (unless otherwise noted)

Symbol	Parameter	VDD = 1.8V ± 0.1V		Units
		Min.	Max.	
fMAX	Max Input Clock Frequency	410		MHz
tpDM ¹	Propagation Delay, single bit switching, CLK \uparrow / $\overline{\text{CLK}}\downarrow$ to Qn	1.1	1.5	ns
tpDQ ²	Propagation Delay, single-bit switching, CLK \uparrow / $\overline{\text{CLK}}\downarrow$ to Qn	0.4	0.8	ns
tpDMSS ¹	Propagation Delay, simultaneous switching, CLK \uparrow / $\overline{\text{CLK}}\downarrow$ to Qn		1.6	ns
tpD	Propagation Delay, CLK \uparrow / $\overline{\text{CLK}}\downarrow$ to PPO	0.5	1.7	ns
tLH	LOW to HIGH Propagation Delay, CLK \uparrow / $\overline{\text{CLK}}\downarrow$ to $\overline{\text{QERR}}$	1	3	ns
tHL	HIGH to LOW Propagation Delay, CLK \uparrow / $\overline{\text{CLK}}\downarrow$ to $\overline{\text{QERR}}$	0.9	2.4	ns
tPHL	HIGH to LOW Propagation Delay, $\overline{\text{RESET}}\downarrow$ to PPO to Qn \downarrow		3	ns
tPLH	LOW to HIGH Propagation Delay, $\overline{\text{RESET}}\downarrow$ to $\overline{\text{QERR}}\uparrow$		3	ns

1 Design target as per JEDEC specifications.

2 Production Test. (See Production Test Circuit in TEST CIRCUIT AND WAVEFORM section.)

Output Buffer Characteristics

Output edge rates over recommended operating free-air temperature range

Parameter	VDD = 1.8V ± 0.1V		Units
	Min.	Max.	
dV/dt _r	1	4	V/ns
dV/dt _f	1	4	V/ns
dV/dt _Δ ¹		1	V/ns

1 Difference between dV/dt_r (rising edge rate) and dV/dt_f (falling edge rate).

Register Timing

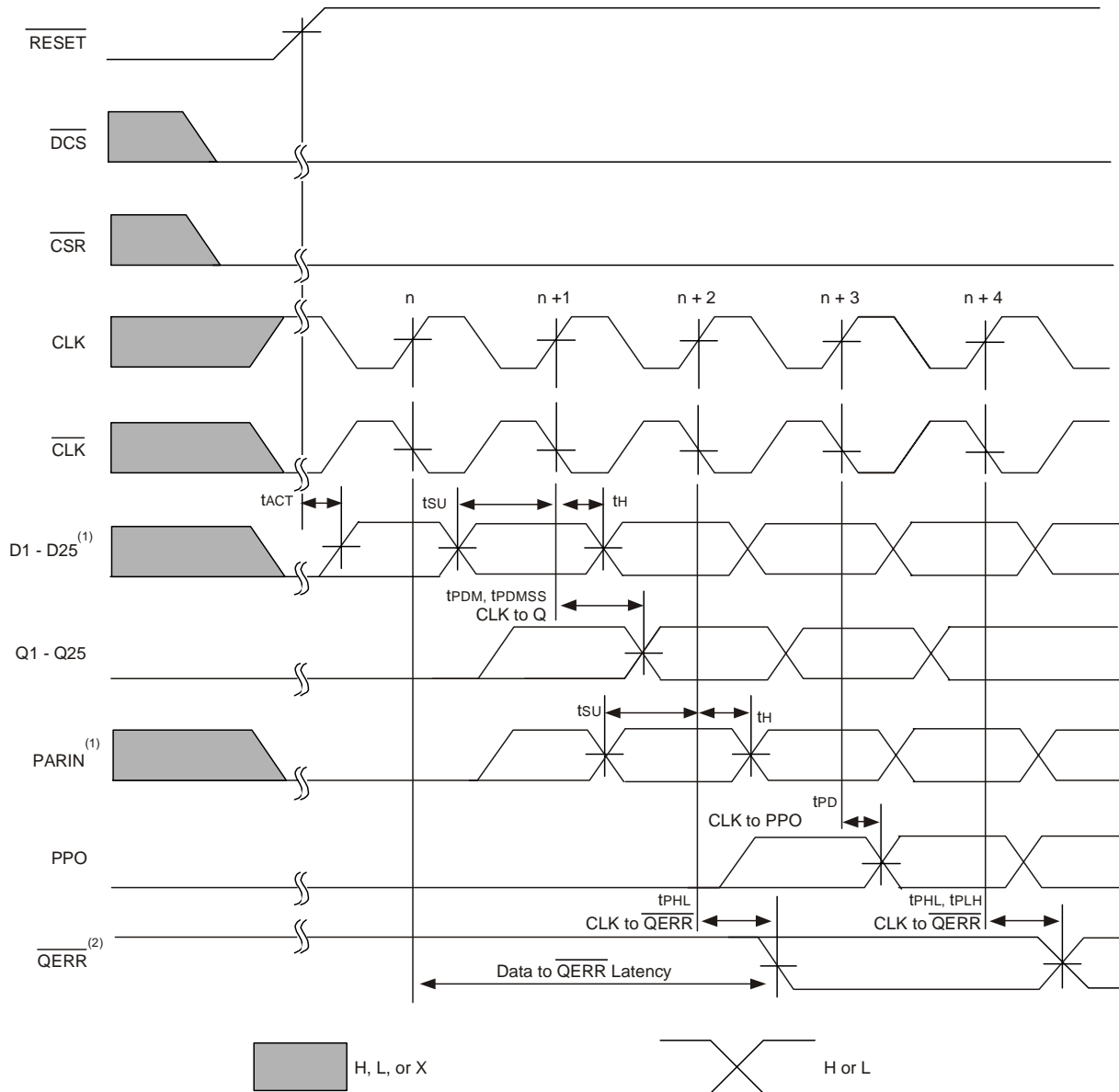

Timing Diagram for SSTUBF32866B Used as a Single Device; $C0 = 0$, $C1 = 0$, $\overline{\text{RESET}}$ Switches from L to H

NOTES:

1. After $\overline{\text{RESET}}$ is switched from LOW to HIGH, all data and $\overline{\text{PAR_IN}}$ inputs signals must be set and held low for a minimum time of t_{ACTMAX} , to avoid false error.
2. If the data is clocked in on the n clock pulse, the $\overline{\text{QERR}}$ output signal will be generated on the $n+2$ clock pulse, and it will be valid on the $n+3$ clock pulse.

Register Timing



Timing Diagram for the First SSTUBF32866B Used as a Single Device; C0 = 0, C1 = 0, $\overline{\text{RESET}}$ Held HIGH

NOTE:

1. If the data is clocked in on the n clock pulse, the $\overline{\text{QERR}}$ output signal will be generated on the $n+2$ clock pulse, and it will be valid on the $n+3$ clock pulse. If an error occurs and the $\overline{\text{QERR}}$ output is driven low, it stays latched low for a minimum of two clock cycles or until $\overline{\text{RESET}}$ is driven low.

Register Timing

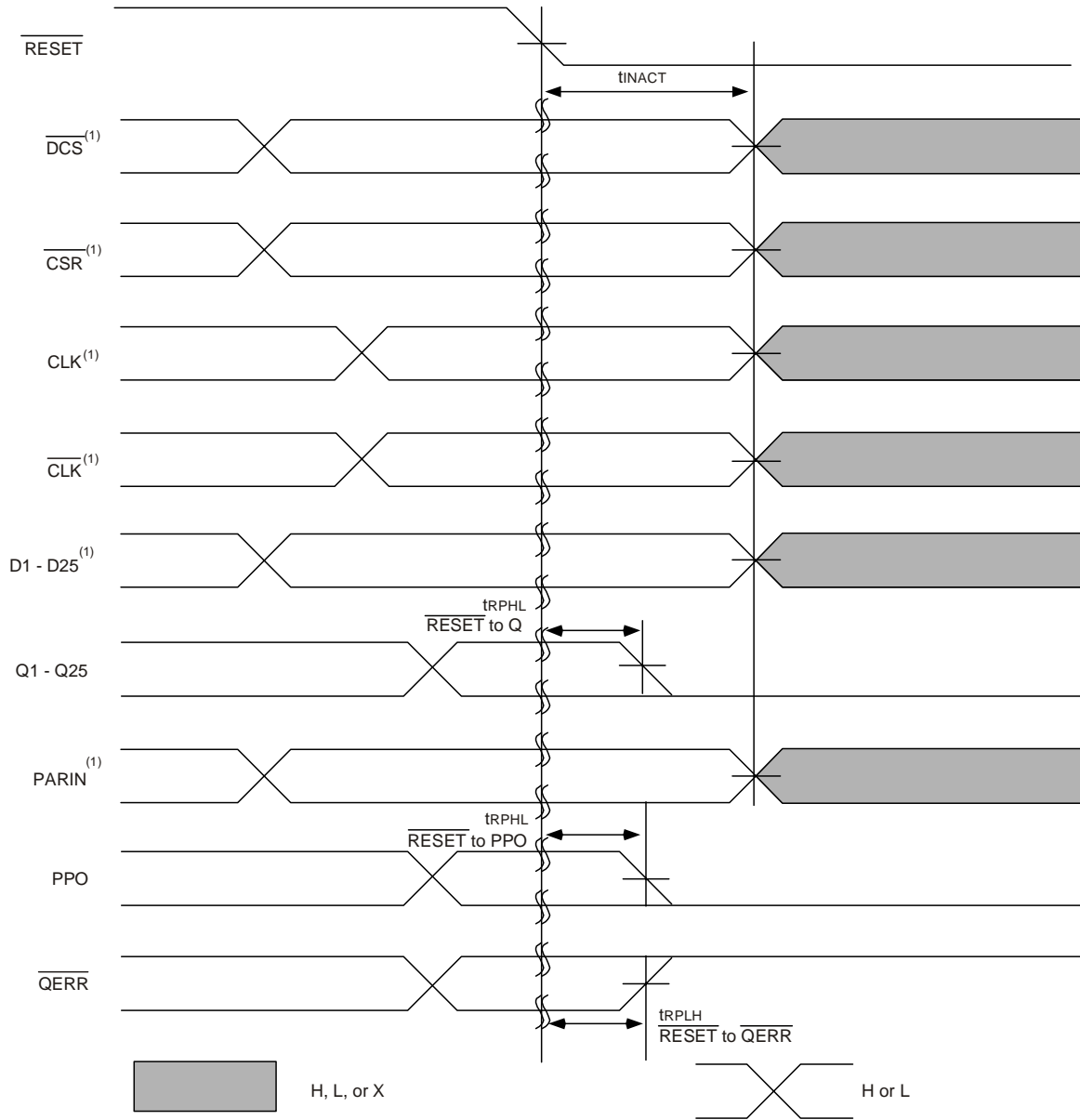

Timing Diagram for SSTUBF32866B Used as a Single Device; C0 = 0, C1 = 0, $\overline{\text{RESET}}$ Switches from H to L

NOTE:

1. After $\overline{\text{RESET}}$ is switched from HIGH to LOW, all data and clock inputs signals must be set and held at valid logic levels (not floating) for a minimum time of t_{INACTMAX} .

Register Timing

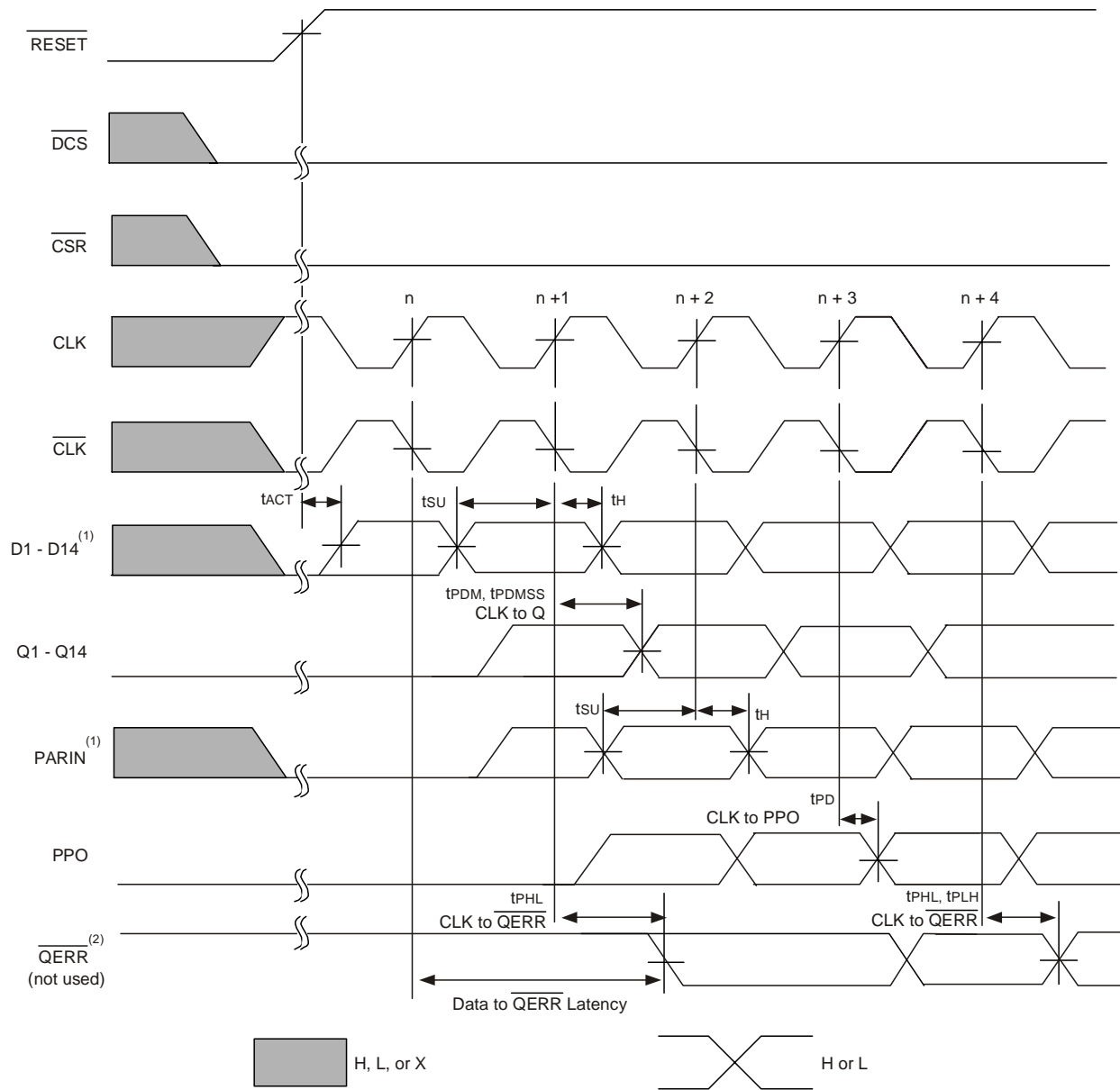

Timing Diagram for the First SSTUBF32866B (1:2 Register-A Configuration) Device Used in a Pair; C0 = 0, C1 = 1, RESET Switches from L to H

NOTES:

1. After \overline{RESET} is switched from LOW to HIGH, all data and PAR_IN inputs signals must be set and held low for a minimum time of t_{ACTMAX} , to avoid false error.
2. If the data is clocked in on the n clock pulse, the \overline{QERR} output signal will be generated on the n+1 clock pulse, and it will be valid on the n+2 clock pulse.

Register Timing

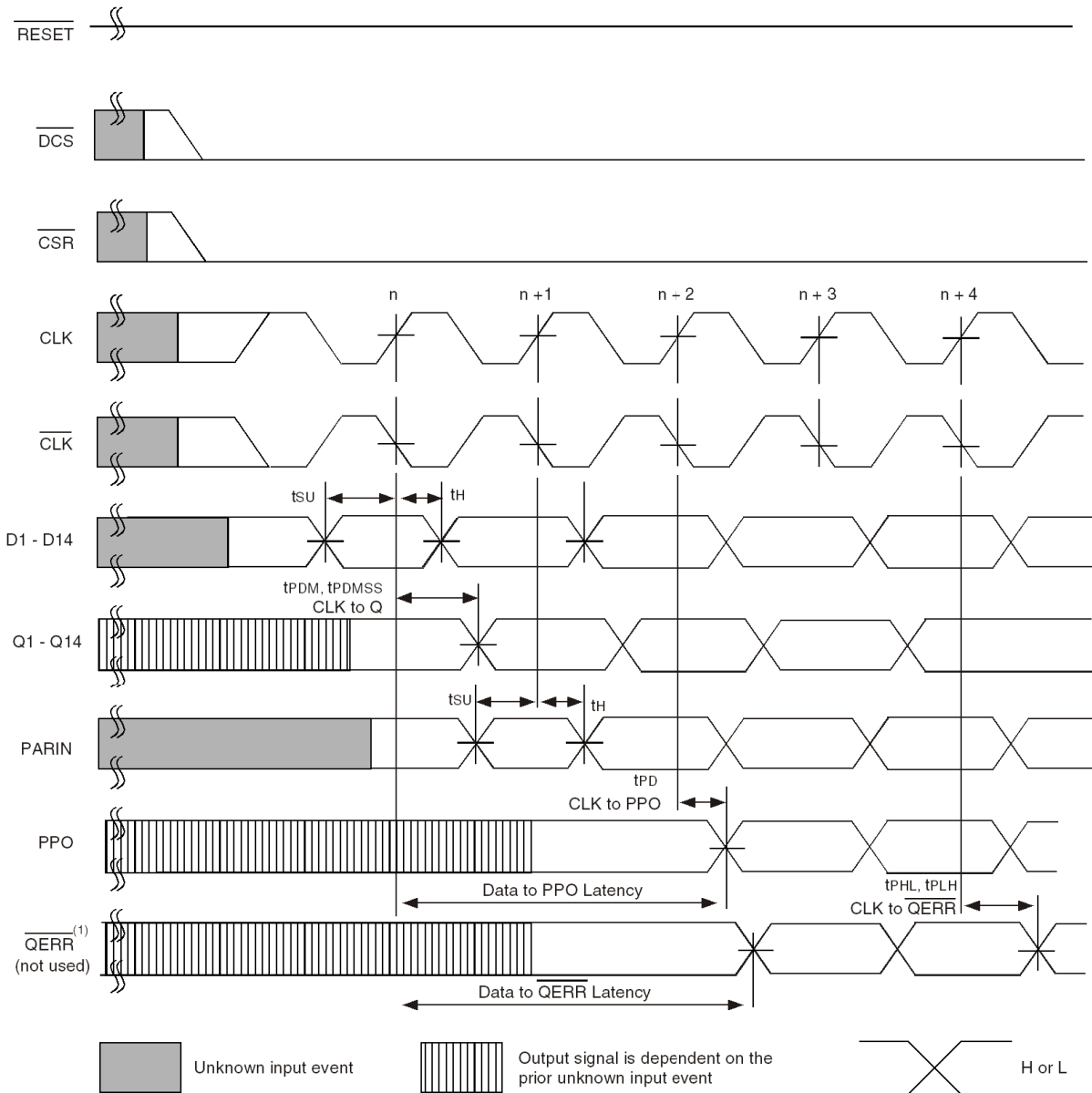

Timing Diagram for the First SSTUBF32866B (1:2 Register-A Configuration) Device Used in a Pair; C0 = 0, C1 = 1, \overline{RESET} Held HIGH

NOTE:

1. If the data is clocked in on the n clock pulse, the \overline{QERR} output signal will be generated on the n+1 clock pulse, and it will be valid on the n+2 clock pulse. If an error occurs and the \overline{QERR} output is driven low, it stays latched low for a minimum of two clock cycles or until \overline{RESET} is driven low.

Register Timing

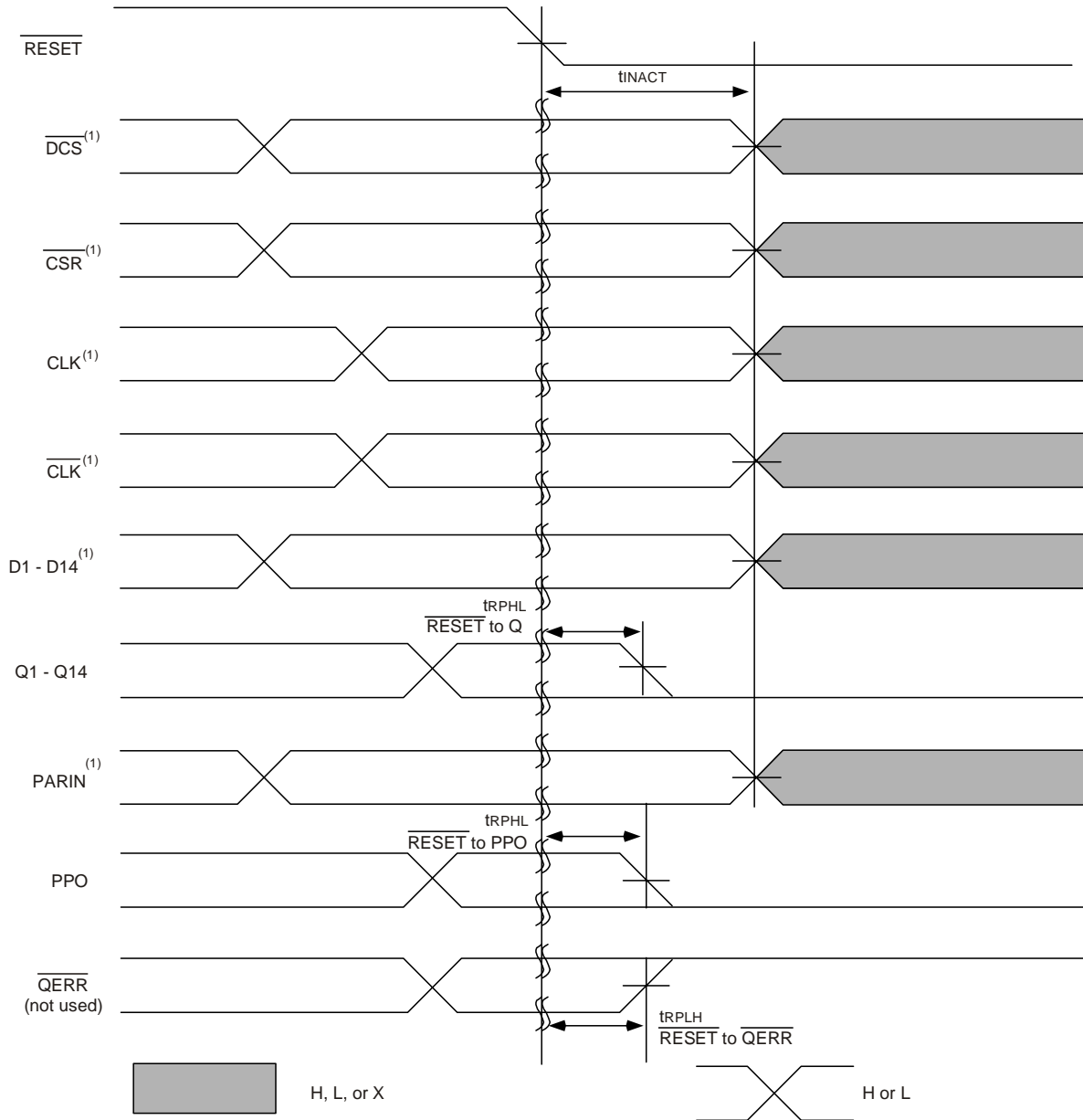

Timing Diagram for the First SSTUBF32866B (1:2 Register-A Configuration) Device Used in a Pair; $\text{C0} = 1$, $\text{C1} = 1$; $\overline{\text{RESET}}$ Switches from H to L

NOTE:

1. After $\overline{\text{RESET}}$ is switched from HIGH to LOW, all data and clock inputs signals must be set and held at valid logic levels (not floating) for a minimum time of t_{INACTMAX} .

Register Timing

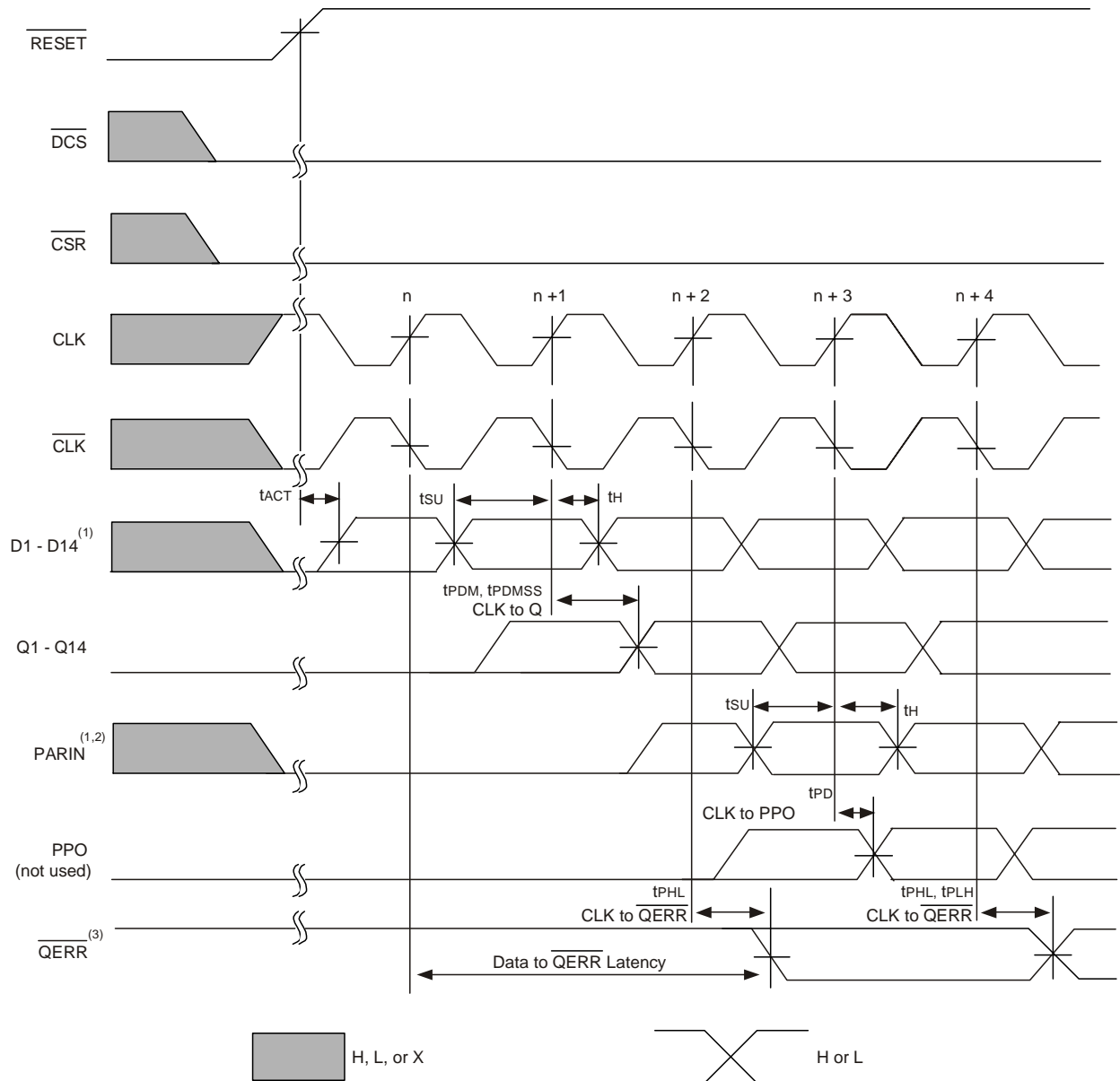

Timing Diagram for the Second SSTUBF32866B (1:2 Register-B Configuration) Device Used in a Pair; C0 = 1, C1 = 1, \overline{RESET} Switches from L to H

NOTES:

1. After \overline{RESET} is switched from LOW to HIGH, all data and PAR_IN inputs signals must be set and held low for a minimum time of t_{actmax} , to avoid false error.
2. PAR_IN is driven from PPO of the first SSTUAF32866 device.
3. If the data is clocked in on the n clock pulse, the \overline{QERR} output signal will be generated on the n+2 clock pulse, and it will be valid on the n+3 clock pulse.

Register Timing



Timing Diagram for the Second SSTUBF32866B (1:2 Register-B Configuration) Device Used in a Pair; C0 = 1, C1 = 1, $\overline{\text{RESET}}$ Held HIGH

NOTES:

- 1.If the data is clocked in on the n clock pulse, the $\overline{\text{QERR}}$ output signal will be generated on the n+1 clock pulse, and it will be valid on the n+2 clock pulse. If an error occurs and the $\overline{\text{QERR}}$ output is driven low, it stays latched low for a minimum of two clock cycles or until $\overline{\text{RESET}}$ is driven low.
- 2.PAR_IN is driven from PPO of the first SSTUAF32866 device.

Register Timing

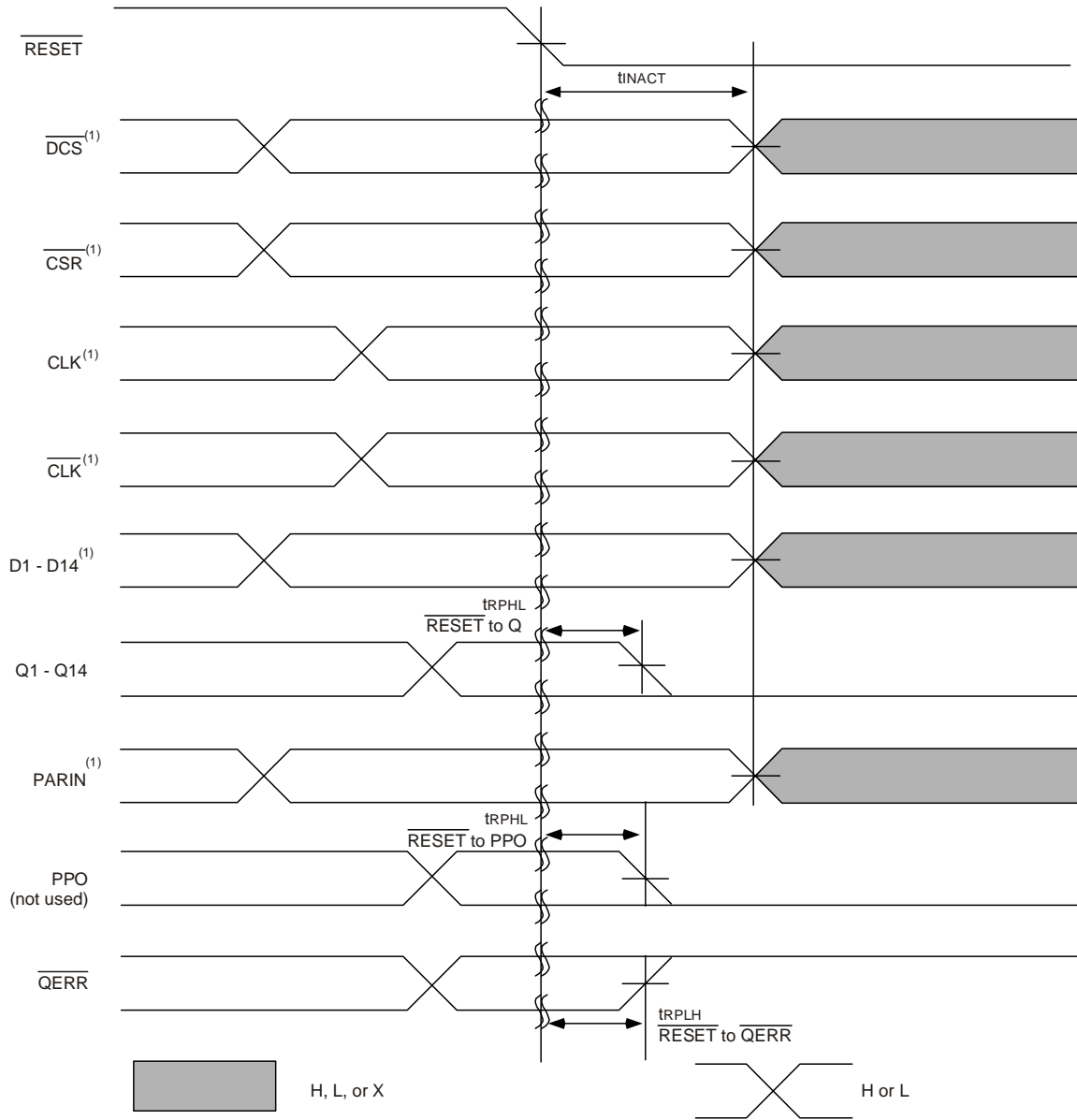

Timing Diagram for the First SSTUBF32866B (1:2 Register-A Configuration) Device Used in a Pair; C0 = 1, C1 = 1; $\overline{\text{RESET}}$ Switches from H to L

NOTE:

1. After $\overline{\text{RESET}}$ is switched from HIGH to LOW, all data and clock inputs signals must be set and held at valid logic levels (not floating) for a minimum time of t_{INACTMAX} .

Test Circuits and Waveforms ($V_{DD} = 1.8V \pm 0.1V$)



Simulation Load Circuit

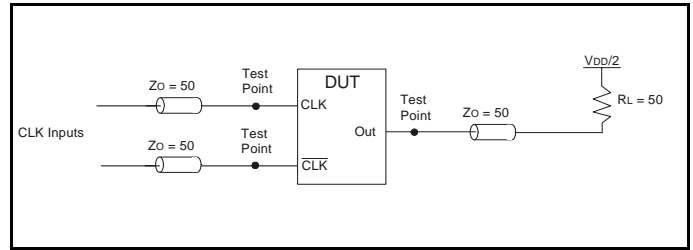

Production-Test Load Circuit

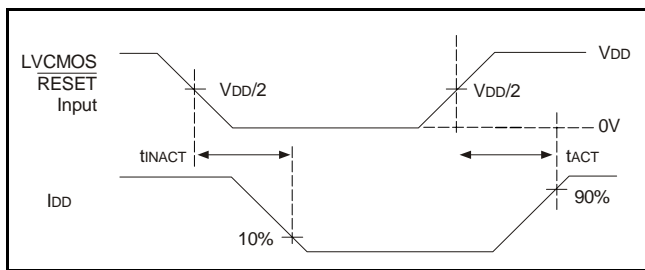

Voltage and Current Waveforms Inputs Active and Inactive Times

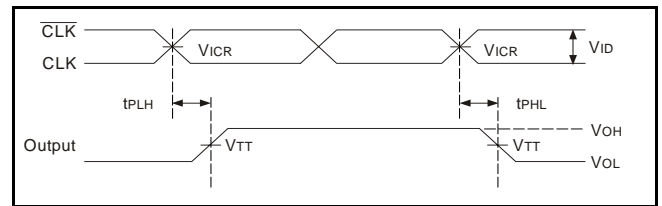

Voltage Waveforms - Propagation Delay Times

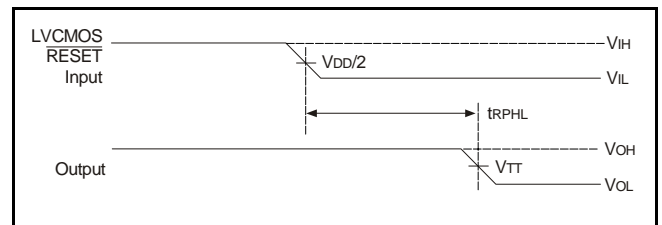

Voltage Waveforms - Propagation Delay Times

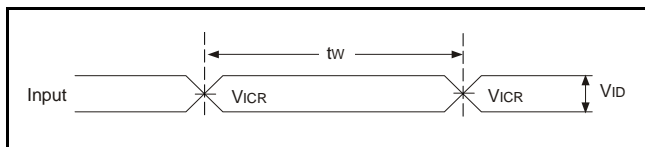

Voltage Waveforms - Pulse Duration

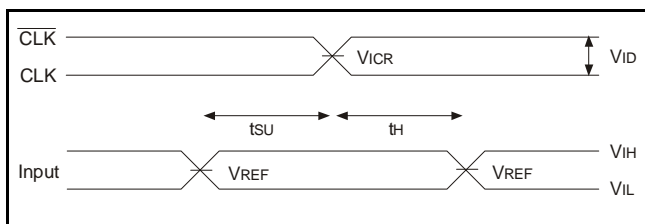

Voltage Waveforms - Setup and Hold Times

NOTES:

1. CL includes probe and jig capacitance.
2. IDD tested with clock and data inputs held at VDD or GND, and $I_o = 0mA$
3. All input pulses are supplied by generators having the following characteristics: PRR $\leq 10MHz$, $Z_o = 50\Omega$, input slew rate = $1 V/ns \pm 20\%$ (unless otherwise specified).
4. The outputs are measured one at a time with one transition per measurement.
5. $V_{TT} = V_{REF} = V_{DD}/2$
6. $V_{IH} = V_{REF} + 250mV$ (AC voltage levels) for differential inputs. $V_{IH} = V_{DD}$ for LVC MOS input.
7. $V_{IL} = V_{REF} - 250mV$ (AC voltage levels) for differential inputs. $V_{IL} = GND$ for LVC MOS input.
8. $V_{ID} = 600mV$.
9. tPLH and tPHL are the same as tPDM.

Test Circuits and Waveforms ($V_{DD} = 1.8V \pm 0.1V$)



Load Circuit: High-to-Low Slew-Rate Adjustment



Voltage Waveforms: High-to-Low Slew-Rate Adjustment

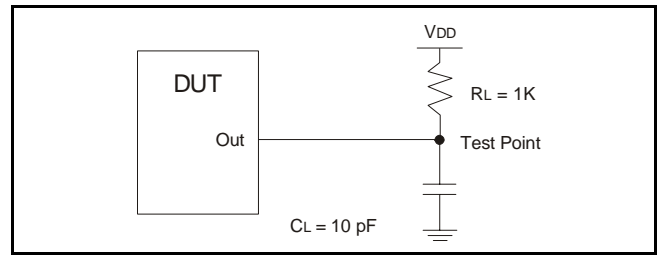

Load Circuit: Error Output Measurements

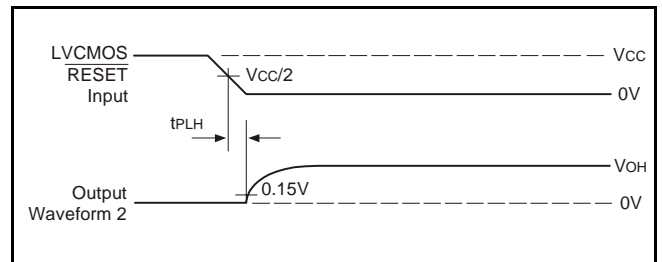

Voltage Waveforms: Open Drain Output Low-to-High Transition Time (with respect to \overline{RESET} input)

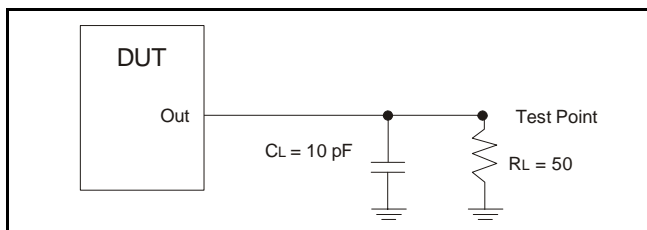

Load Circuit: Low-to-High Slew-Rate Adjustment

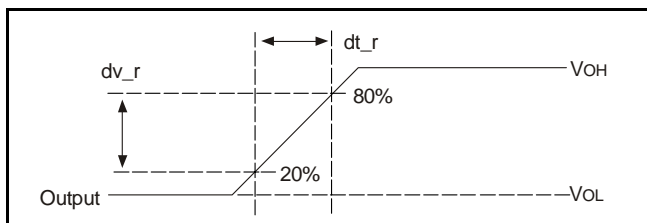

Voltage Waveforms: Low-to-High Slew-Rate Adjustment

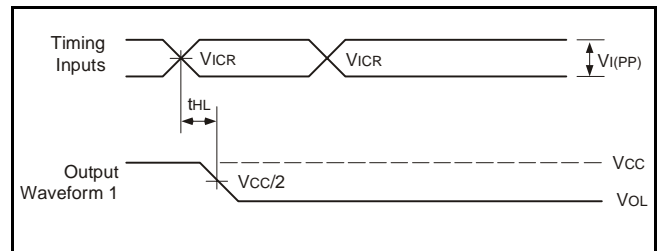

Voltage Waveforms: Open Drain Output High-to-Low Transition Time (with respect to clock inputs)

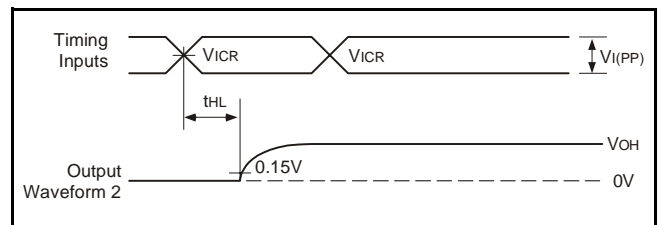

Voltage Waveforms: Open Drain Output Low-to-High Transition Time (with respect to clock inputs)

NOTES:

1. C_L includes probe and jig capacitance.
2. All input pulses are supplied by generators having the following characteristics: PRR $\leq 10\text{MHz}$, $Z_o = 50\Omega$, input slew rate = $1\text{ V/ns} \pm 20\%$ (unless otherwise specified).

Test Circuits and Waveforms ($V_{DD} = 1.8V \pm 0.1V$)

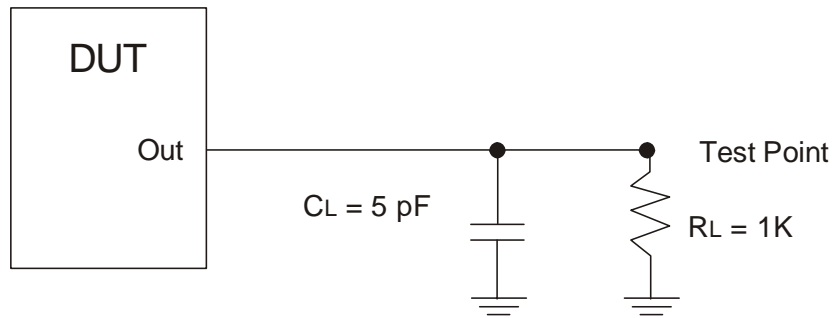

Load Circuit: Partial-Parity-Out Load Circuit

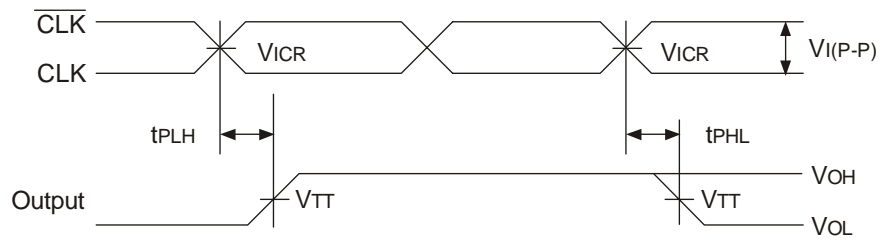

Load Circuit: Partial-Parity-Out Voltage Waveforms Propagation Delay Times (with respect to clock inputs)

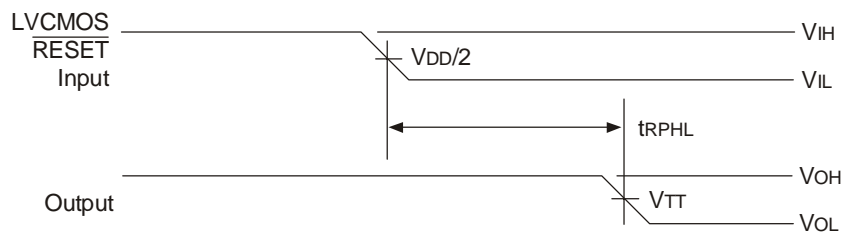

Load Circuit: Partial-Parity-Out Voltage Waveforms Propagation Delay Times (with respect to $\overline{\text{RESET}}$ input)

Ordering Information

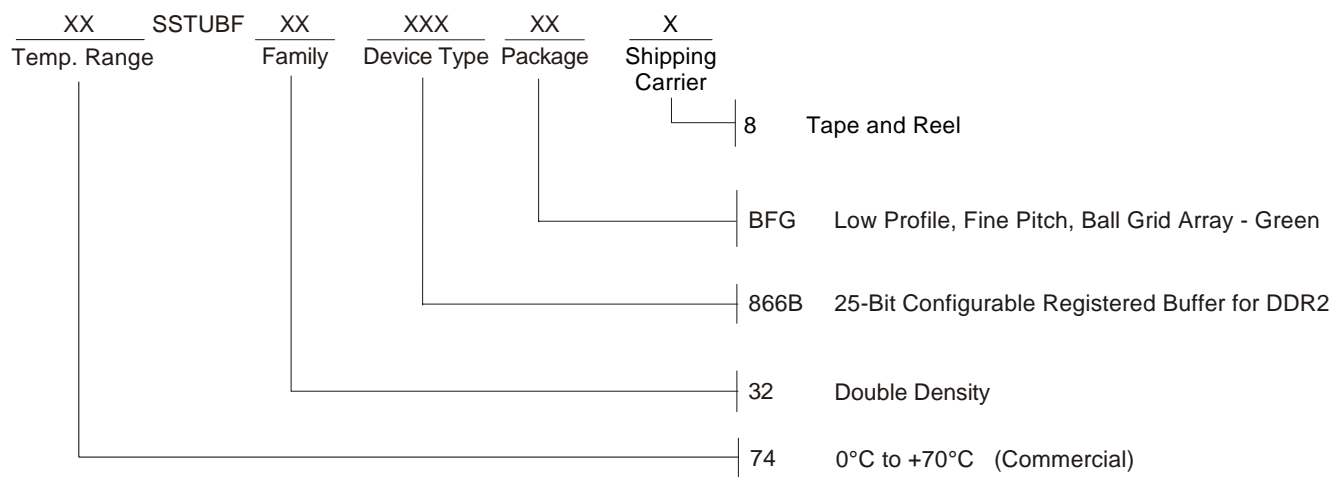

IDT74SSTUBF32866B

25-BIT CONFIGURABLE REGISTERED BUFFER FOR DDR2

COMMERCIAL TEMPERATURE GRADE

IMPORTANT NOTICE AND DISCLAIMER

RENESAS ELECTRONICS CORPORATION AND ITS SUBSIDIARIES (“RENESAS”) PROVIDES TECHNICAL SPECIFICATIONS AND RELIABILITY DATA (INCLUDING DATASHEETS), DESIGN RESOURCES (INCLUDING REFERENCE DESIGNS), APPLICATION OR OTHER DESIGN ADVICE, WEB TOOLS, SAFETY INFORMATION, AND OTHER RESOURCES “AS IS” AND WITH ALL FAULTS, AND DISCLAIMS ALL WARRANTIES, EXPRESS OR IMPLIED, INCLUDING, WITHOUT LIMITATION, ANY IMPLIED WARRANTIES OF MERCHANTABILITY, FITNESS FOR A PARTICULAR PURPOSE, OR NON-INFRINGEMENT OF THIRD PARTY INTELLECTUAL PROPERTY RIGHTS.

These resources are intended for developers skilled in the art designing with Renesas products. You are solely responsible for (1) selecting the appropriate products for your application, (2) designing, validating, and testing your application, and (3) ensuring your application meets applicable standards, and any other safety, security, or other requirements. These resources are subject to change without notice. Renesas grants you permission to use these resources only for development of an application that uses Renesas products. Other reproduction or use of these resources is strictly prohibited. No license is granted to any other Renesas intellectual property or to any third party intellectual property. Renesas disclaims responsibility for, and you will fully indemnify Renesas and its representatives against, any claims, damages, costs, losses, or liabilities arising out of your use of these resources. Renesas' products are provided only subject to Renesas' Terms and Conditions of Sale or other applicable terms agreed to in writing. No use of any Renesas resources expands or otherwise alters any applicable warranties or warranty disclaimers for these products.

(Rev.1.0 Mar 2020)

Corporate Headquarters

TOYOSU FORESIA, 3-2-24 Toyosu,
Koto-ku, Tokyo 135-0061, Japan
www.renesas.com

Contact Information

For further information on a product, technology, the most up-to-date version of a document, or your nearest sales office, please visit:
www.renesas.com/contact/

Trademarks

Renesas and the Renesas logo are trademarks of Renesas Electronics Corporation. All trademarks and registered trademarks are the property of their respective owners.