

Features

- Small Body Outline Dimensions:
0.039" x 0.024" (1.0 mm x 0.60 mm)
- Protects one I/O or power line
- Low Clamping Voltage
- Ultra Low Capacitance:0.5pF
- Working Voltage: 5 V
- Low Leakage Current

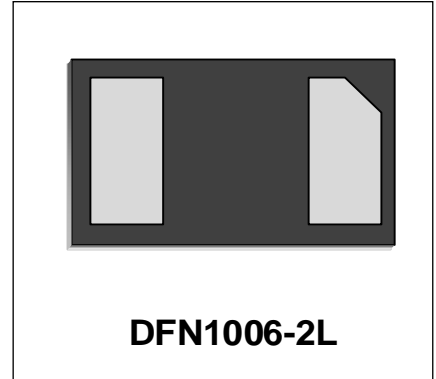

IEC COMPATIBILITY (EN61000-4)

- IEC 61000-4-2 (ESD) $\pm 15\text{kV}$ (air), $\pm 10\text{kV}$ (contact)
- IEC 61000-4-4 (EFT) 40A (5/50ns)
- IEC 61000-4-5 (Lightning) 3A (8/20 μs)

Mechanical Characteristics

- DFN1006-2L package
- Marking: Marking Code
- Packaging: Tape and Reel per EIA 481
- RoHS Compliant

Applications

- Laptop Computers
- Cellular Phones
- Digital Cameras
- Personal Digital Assistants (PDAs)

Schematic & PIN Configuration

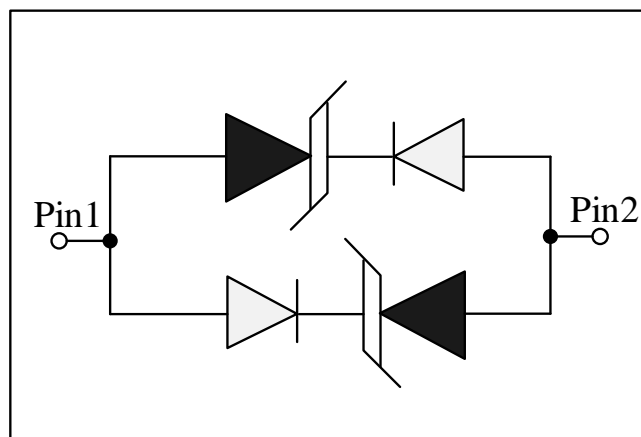

| Absolute Maximum Rating | | | |
|--|-----------|--------------|-------|
| Rating | Symbol | Value | Units |
| Peak Pulse Power ($t_p = 8/20\mu s$) | P_{PP} | 60 | W |
| Peak Pulse Current ($t_p = 8/20\mu s$) | I_{PP} | 3 | A |
| Operating Temperature | T_J | -55 to + 125 | °C |
| Storage Temperature | T_{STG} | -55 to +150 | °C |

Electrical Parameters (T=25°C)

| Symbol | Parameter |
|-----------|-------------------------------------|
| I_{PP} | Reverse Peak Pulse Current |
| V_C | Clamping Voltage @ I_{PP} |
| V_{RWM} | Reverse Stand-Off Voltage |
| I_R | Reverse Leakage Current @ V_{RWM} |
| V_{BR} | Breakdown Voltage @ I_T |
| I_T | Test Current |

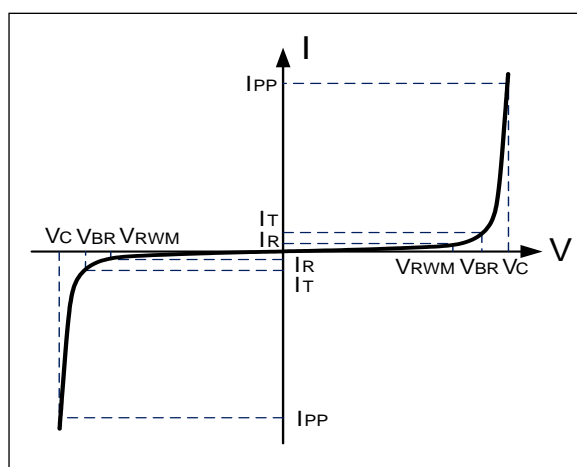

Electrical Characteristics

| WE05DUCF-B | | | | | | |
|-----------------------------------|-----------|---|---------|---------|---------|----------|
| Parameter | Symbol | Conditions | Minimum | Typical | Maximum | Units |
| Reverse Stand-Off Voltage | V_{RWM} | | | | 5 | V |
| Reverse Breakdown Voltage | V_{BR} | $I_T = 1\text{mA}$ | 6 | | | V |
| Reverse Leakage Current | I_R | $V_{RWM} = 5\text{V}, T = 25^\circ\text{C}$ | | | 150 | nA |
| Clamping Voltage | V_C | $I_{PP} = 3\text{A}, t_p = 8/20\mu s$ | | | 20 | V |
| ESD Clamping Voltage ¹ | V_C | $I_{PP} = 4\text{A}$ $t_p = 0.2/100\text{ns}$ | | 14.2 | | V |
| ESD Clamping Voltage ¹ | V_C | $I_{PP} = 16\text{A}$ $t_p = 0.2/100\text{ns}$ | | 28 | | V |
| Dynamic Resistance ^{1,2} | R_{DYN} | TLP=0.2/100ns | | 1.15 | | Ω |
| Junction Capacitance | C_j | $V_R = 0\text{V}, f = 1\text{MHz}$ | | 0.5 | 0.8 | pF |

Note: 1、 TLP Setting : $t_p = 100\text{ns}$, $t_r = 0.2\text{ns}$, I_{TLP} and V_{TLP} sample window: $t_1 = 70\text{ns}$ to $t_2 = 90\text{ns}$.
 2、 Dynamic resistance calculated from $I_{PP} = 4\text{A}$ to $I_{PP} = 16\text{A}$ using "Best Fit".

Typical Characteristics

Figure 1: Peak Pulse Power vs. Pulse Time

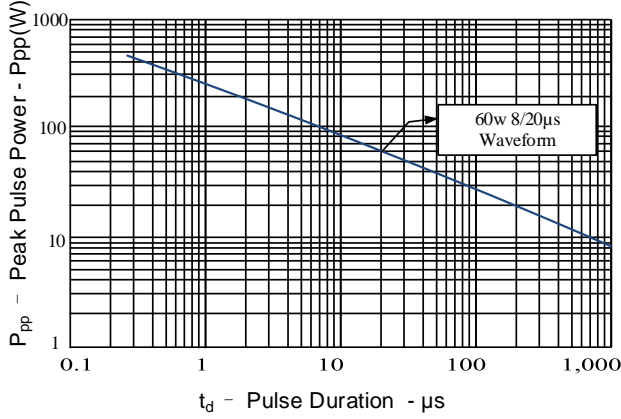

Figure 2: Power Derating Curve

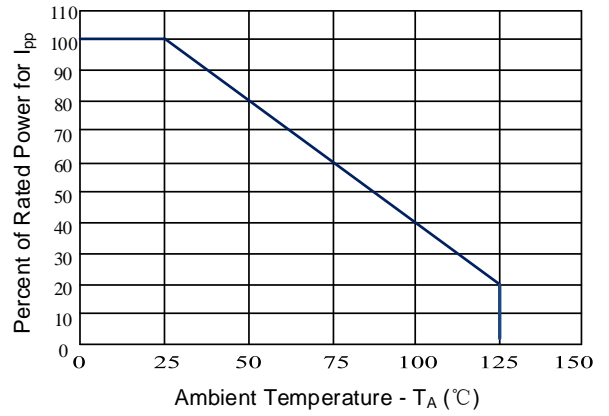

Figure 3: Clamping Voltage vs. Peak Pulse Current

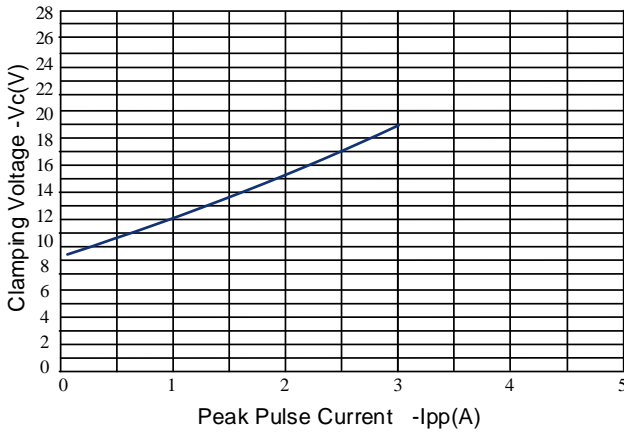

Figure 4: Normalized Junction Capacitance

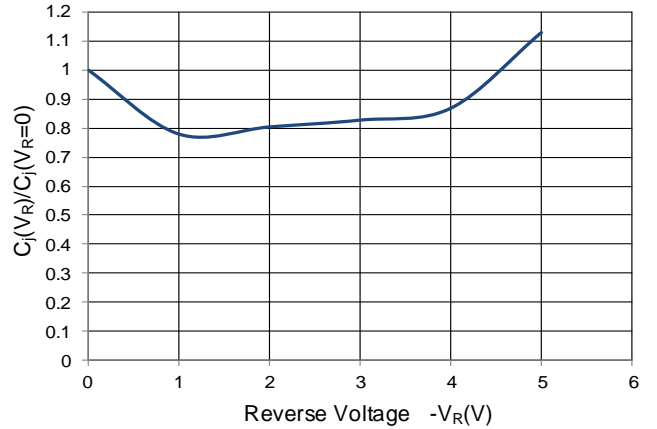

Figure 5: TLP Positive I-V Curve

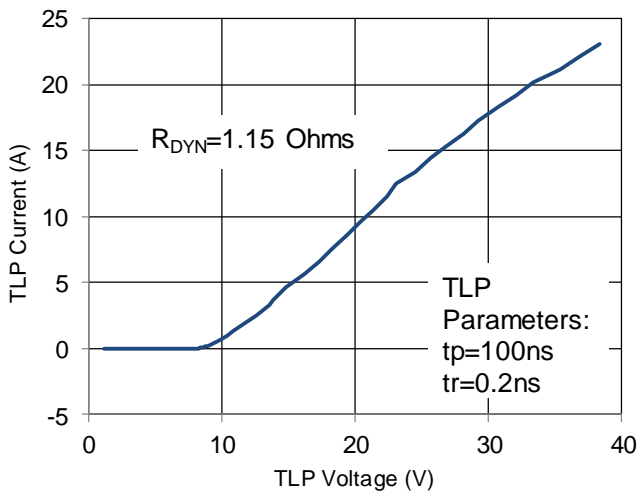
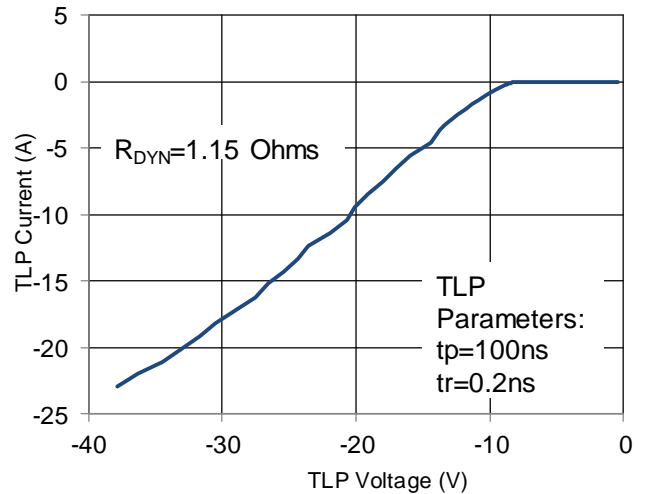
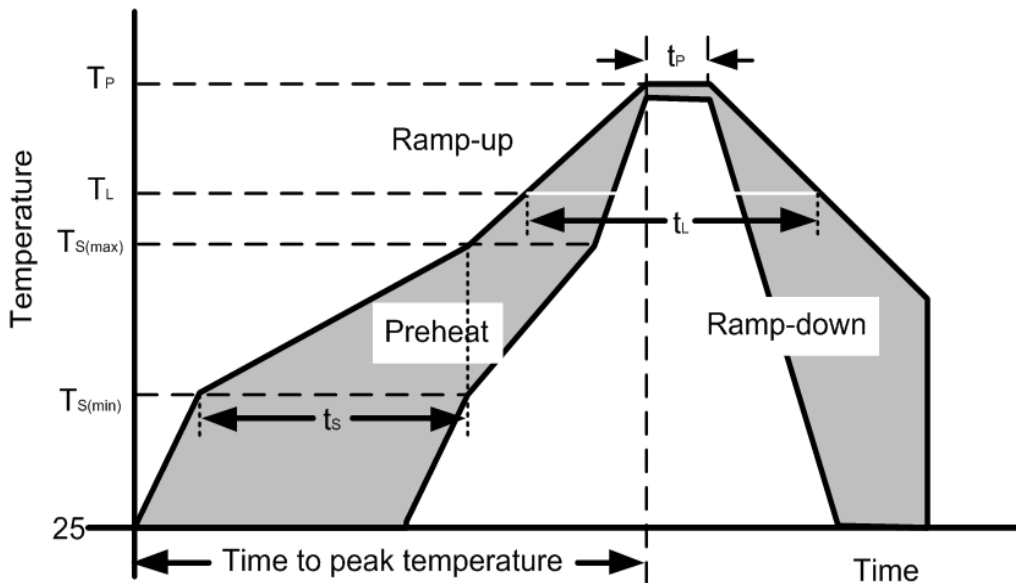

Figure 6: TLP Negative I-V Curve



Soldering Parameters

| Reflow Condition | | Pb – Free assembly |
|--|----------------------------------|--------------------|
| Pre Heat | Temperature Min ($T_{S(min)}$) | 150°C |
| | Temperature Max ($T_{S(max)}$) | 200°C |
| | Time (min to max) (t_s) | 60 – 190 secs |
| Average ramp up rate (Liquidus Temp) (T_L) to peak | | 5°C/second max |
| $T_{S(max)}$ to T_L —Ramp-up Rate | | 5°C/second max |
| Reflow | Temperature (T_L) (Liquidus) | 217°C |
| | Temperature (t_L) | 60 – 150 seconds |
| Peak Temperature (T_P) | | 260+0/-5 °C |
| Time within actual peak Temperature (t_p) | | 20 – 40 seconds |
| Ramp-down Rate | | 5°C/second max |
| Time 25°C to peak Temperature (T_P) | | 8 minutes Max. |
| Do not exceed | | 280°C |



Outline Drawing –DFN1006-2L

PACKAGE OUTLINE

BOTTOM VIEW

DFN1006-2L

| SYMBOL | MILIMETER | | |
|--------|-----------|------|------|
| | MIN | NOM | MAX |
| A | 0.45 | 0.50 | 0.55 |
| A1 | 0 | 0.02 | 0.05 |
| b | 0.45 | 0.50 | 0.55 |
| C | 0.12 | 0.15 | 0.18 |
| D | 0.95 | 1.00 | 1.05 |
| e | 0.65BSC | | |
| E | 0.55 | 0.60 | 0.65 |
| L | 0.20 | 0.25 | 0.30 |
| L1 | 0.05REF | | |
| h | 0.07 | 0.12 | 0.17 |

Land Pattern

Marking Codes

| Part Number | Marking Code |
|-------------|---|
| WE05DUCF-B | <div style="border: 1px solid black; padding: 5px; display: inline-block;"> 1 5 T 2 </div> |

Package Information

Qty: 10k/Reel

CONTACT INFORMATION

No.1001, Shiwan (7) Road, Pudong District, Shanghai, P.R.China.201207

Tel: 86-21-68969993 Fax: 86-21-50757680 Email: market@way-on.com

WAYON website: <http://www.way-on.com>

For additional information, please contact your local Sales Representative.

WAYON ® is registered trademark of Wayon Corporation.

Specifications are subject to change without notice.
The device characteristics and parameters in this data sheet can and do vary in different applications and actual device performance may vary over time.
Users should verify actual device performance in their specific applications.