



MCH3914

N-Channel JFET 15V, 16 to 50mA, 29mS, MCPH3

ON Semiconductor®

<http://onsemi.com>

Features

- $|y_{fs}|$ is large
- C_{iss} is small
- Small package
- FBET process
- Halogen free compliance

Specifications

Absolute Maximum Ratings at $T_a=25^\circ\text{C}$

Parameter	Symbol	Conditions	Ratings	Unit
Drain-to-Source Voltage	V_{DSX}		15	V
Gate-to-Drain Voltage	V_{GDS}		-15	V
Gate Current	I_G		5	mA
Drain Current	I_D		50	mA
Allowable Power Dissipation	P_D	When mounted on ceramic substrate (600mm ² ×0.8mm)	300	mW
Junction Temperature	T_j		150	°C
Storage Temperature	T_{stg}		-55 to +150	°C

This product is designed to "ESD immunity < 200V**", so please take care when handling.

* Machine Model

Stresses exceeding those listed in the Maximum Ratings table may damage the device. If any of these limits are exceeded, device functionality should not be assumed, damage may occur and reliability may be affected.

Package Dimensions

unit : mm (typ)

7019A-006

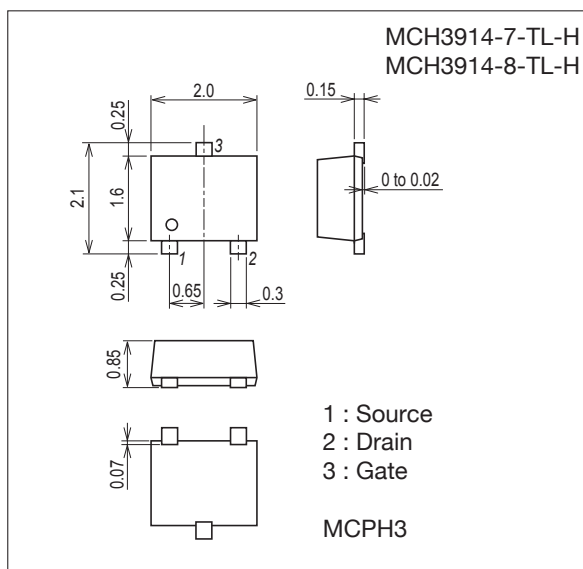

Product & Package Information

- Package : MCPH3
- JEITA, JEDEC : SC-70, SOT-323
- Minimum Packing Quantity : 3,000 pcs./reel

Packing Type : TL

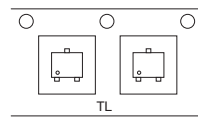

Marking

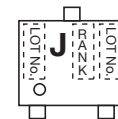

Electrical Connection

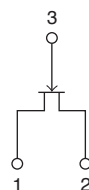

ORDERING INFORMATION

See detailed ordering and shipping information on page 2 of this data sheet.

MCH3914

Electrical Characteristics at Ta=25°C

Parameter	Symbol	Conditions	Ratings			Unit
			min	typ	max	
Gate-to-Drain Breakdown Voltage	V(BR)GDS	I _G =-10μA, V _{DS} =0V	-15			V
Gate-to-Source Leakage Current	I _{GSS}	V _{GS} =-10V, V _{DS} =0V			-1.0	nA
Cutoff Voltage	V _{GS(off)}	V _{DS} =5V, I _D =10μA	-0.6	-1.4	-3.0	V
Zero-Gate Voltage Drain Current	I _{DSS}	V _{DS} =5V, V _{GS} =0V	16.0*		50.0*	mA
Forward Transfer Admittance	y _{fs} 1	V _{DS} =5V, I _D =10mA, f=1kHz	14	21		mS
	y _{fs} 2	V _{DS} =5V, V _{GS} =0V, f=1kHz	14	29		mS
Input Capacitance	C _{iss}	V _{DS} =5V, V _{GS} =0V, f=1MHz		4.9		pF
Reverse Transfer Capacitance	C _{rss}			1.4		pF

Product parametric performance is indicated in the Electrical Characteristics for the listed test conditions, unless otherwise noted. Product performance may not be indicated by the Electrical Characteristics if operated under different conditions.

* : The MCH3914 is classified by I_{DSS} as follows : (unit : mA)

Rank	7	8
I _{DSS}	16.0 to 32.0	25.0 to 50.0

Ordering Information

Device	Package	Shipping	memo
MCH3914-7-TL-H	MCPH3	3,000pcs./reel	Pb Free and Halogen Free
MCH3914-8-TL-H	MCPH3	3,000pcs./reel	

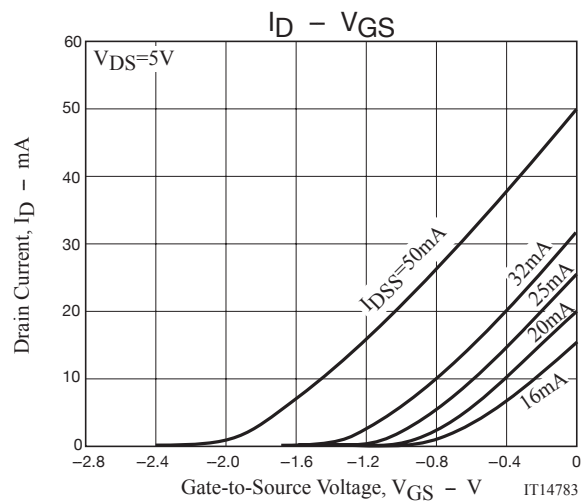
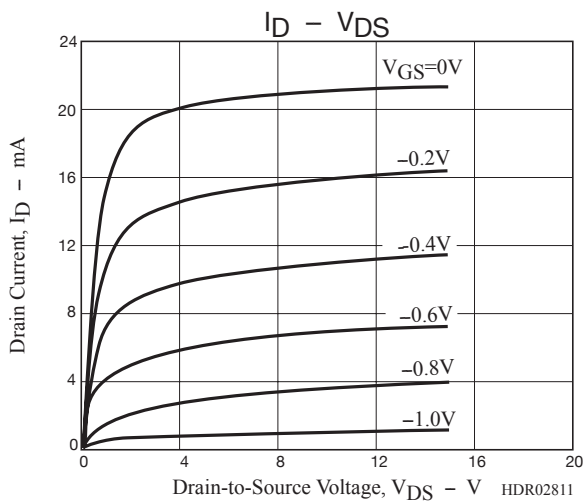

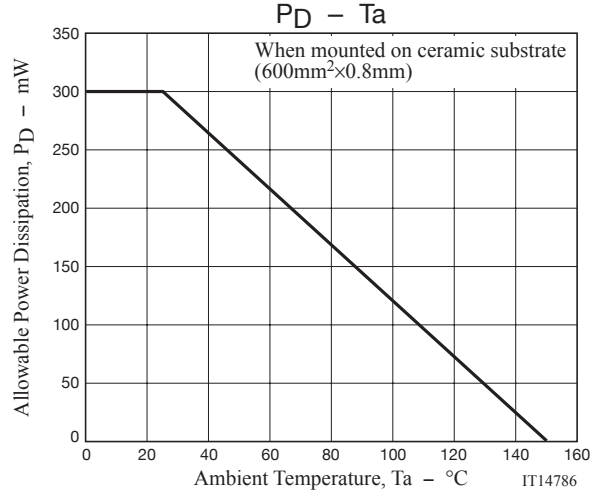
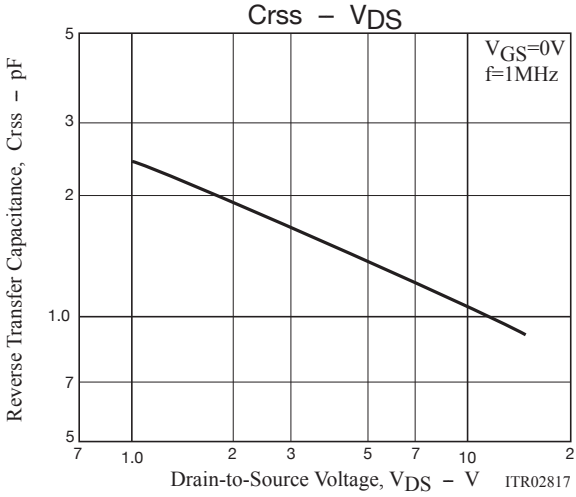
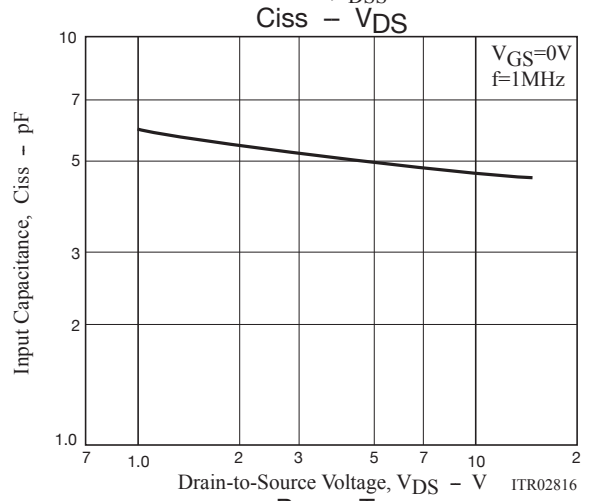
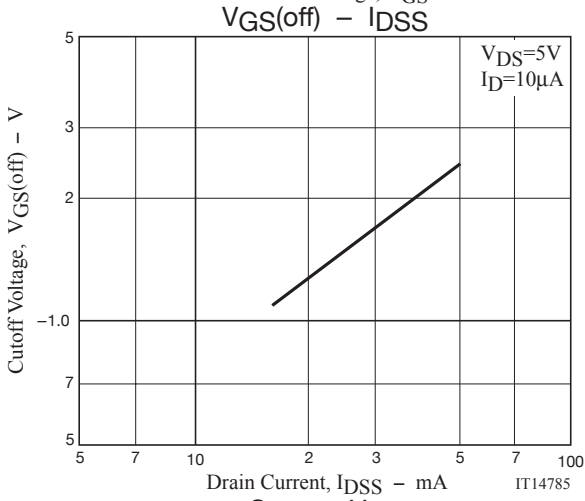
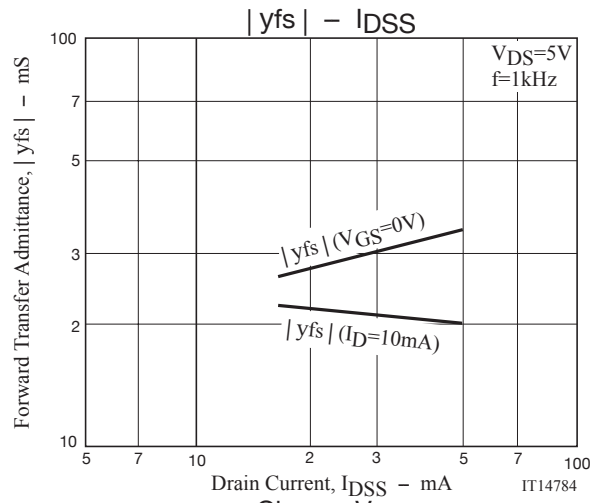
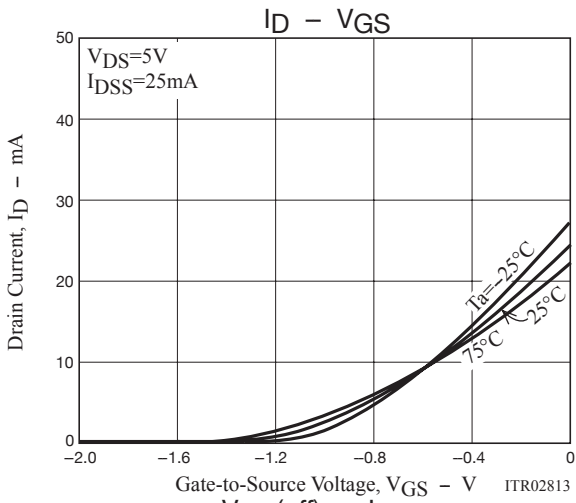

MCH3914

Outline Drawing

MCH3914-7-TL-H, MCH3914-8-TL-H

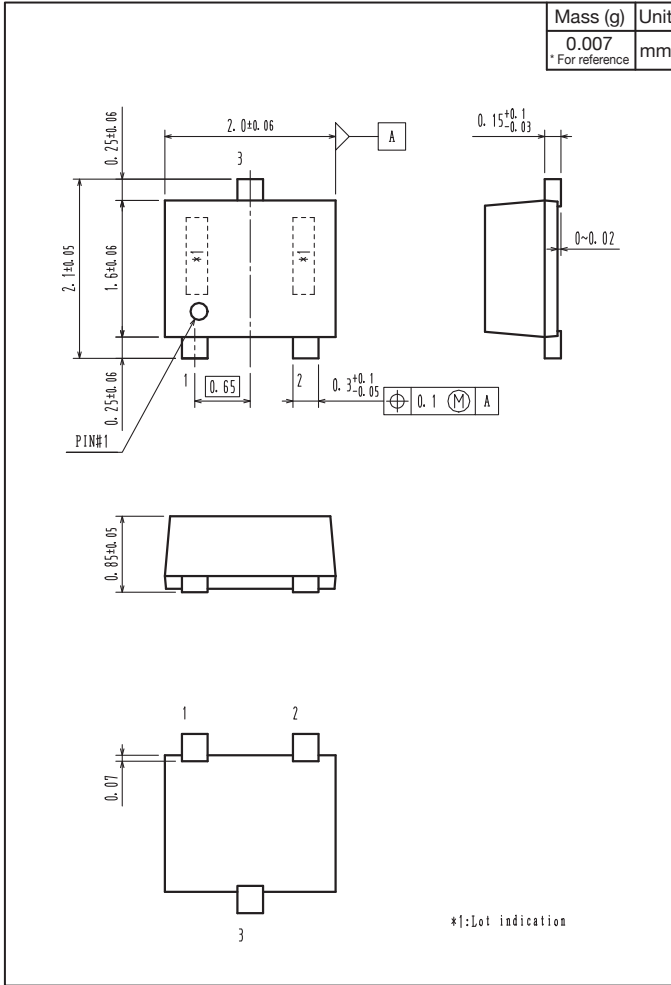

Land Pattern Example

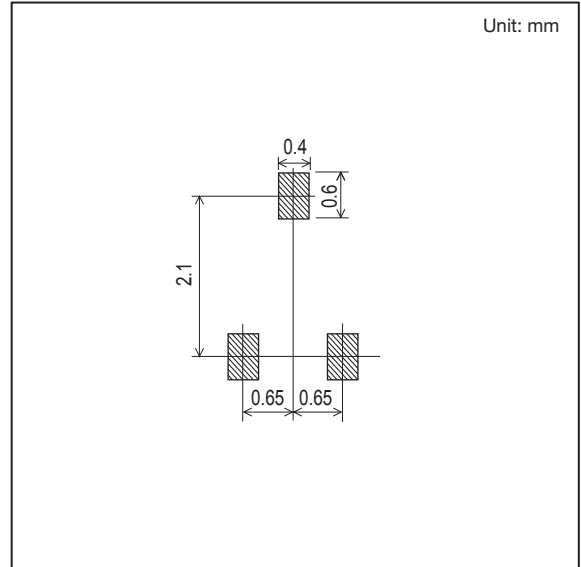

ON Semiconductor and the ON logo are registered trademarks of Semiconductor Components Industries, LLC (SCILLC). SCILLC owns the rights to a number of patents, trademarks, copyrights, trade secrets, and other intellectual property. A listing of SCILLC's product/patent coverage may be accessed at www.onsemi.com/site/pdf/Patent-Marking.pdf. SCILLC reserves the right to make changes without further notice to any products herein. SCILLC makes no warranty, representation or guarantee regarding the suitability of its products for any particular purpose, nor does SCILLC assume any liability arising out of the application or use of any product or circuit, and specifically disclaims any and all liability, including without limitation special, consequential or incidental damages. "Typical" parameters which may be provided in SCILLC data sheets and/or specifications can and do vary in different applications and actual performance may vary over time. All operating parameters, including "Typicals" must be validated for each customer application by customer's technical experts. SCILLC does not convey any license under its patent rights nor the rights of others. SCILLC products are not designed, intended, or authorized for use as components in systems intended for surgical implant into the body, or other applications intended to support or sustain life, or for any other application in which the failure of the SCILLC product could create a situation where personal injury or death may occur. Should Buyer purchase or use SCILLC products for any such unintended or unauthorized application, Buyer shall indemnify and hold SCILLC and its officers, employees, subsidiaries, affiliates, and distributors harmless against all claims, costs, damages, and expenses, and reasonable attorney fees arising out of, directly or indirectly, any claim of personal injury or death associated with such unintended or unauthorized use, even if such claim alleges that SCILLC was negligent regarding the design or manufacture of the part. SCILLC is an Equal Opportunity/Affirmative Action Employer. This literature is subject to all applicable copyright laws and is not for resale in any manner.