

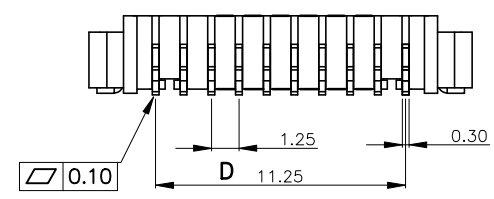

REV.	ECN NO OR DESCRIPTION	REVISED	DATE

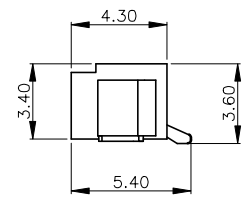
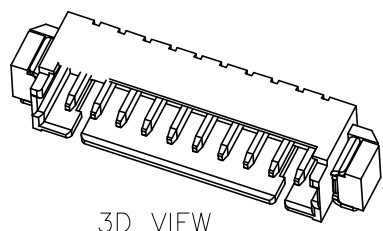
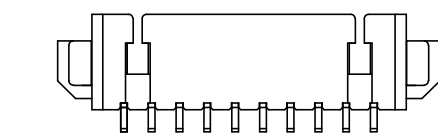
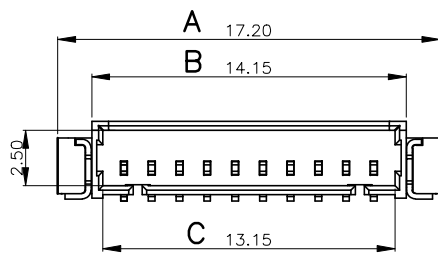
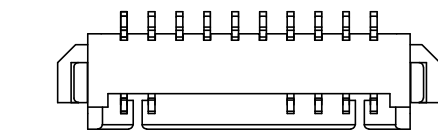

PIN数	A±0.1	B±0.1	C±0.1	D±0.1
2A	7.20	4.15	3.15	1.25
3A	8.45	5.40	4.40	2.50
4A	9.70	6.65	5.65	3.75
5A	10.95	7.90	6.90	5.00
6A	12.20	9.15	8.15	6.25
7A	13.45	10.40	9.40	7.50
8A	14.70	11.65	10.65	8.75
9A	15.95	12.90	11.90	10.00
10A	17.20	14.15	13.15	11.25

Specifications:

1. Rated Voltage : 125V AC/DC
2. Rated Current : 1A AC,DC
3. Withstand Voltage : 200V AC/minute
4. Contact Resistance : 50mΩ(MAX.)
5. Insulation Resistance : 100MΩ(MIN.)
6. Storage Temperature Range: -40°C~+85°C;
7. Operation Temperature Range: -25°C~+70°C;

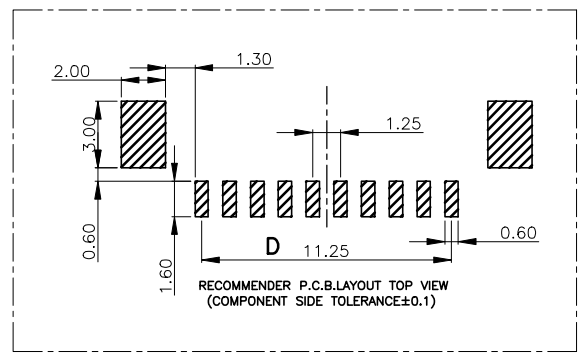

3	插片	黄铜H65	镀镍锡	
2	插针	黄铜H65	镀镍锡	
1	基座	LCP	本色	
序号	品名	材质	电镀/颜色	备注

UNLESS OTHERWISE SPECIFIED TOLERANCES

DECIMALS: X.X :±0.25 X.XX :±0.15 X.XXX :±0.05

ANGLES: X° :±5° X.X° :±3°

TITLE: 针座1.25贴片

DWN: xiong WAFER-125W-NA

CHKD: lee SCALE:1:1 UNIT: mm

APVD: wang SIZE: A4 SHEET:10F 1 REV: A4

CUSTOMER COPY

东莞市汉博电子科技有限公司
DONGGUAN HANBO TECHNOLOGY CO., LTD