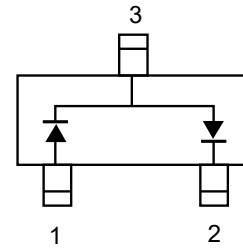
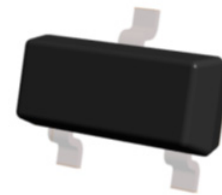

**Description**

The BAV99LT1 is a dual series switching diode  
Pb-Free Packages are available

**Feature**

- Fast Switching Speed
- For General Purpose Switching Applications
- High Conductance

**Electrical characteristics per line@25°C ( unless otherwise specified)**

Parameter	Symbol	Conditions	Min.	Typ.	Max.	Units
Reverse Breakdown Voltage	$V_{BR}$	$I_R = 100\mu A$	70			V
Reverse Leakage Current	$I_R$	$V_R = 70V$			2.5	$\mu A$
Forward Voltage	$V_F$	$I_F = 1mA$			0.715	V
		$I_F = 10mA$			0.855	
		$I_F = 50mA$			1.0	
		$I_F = 150mA$			1.25	
Reverse Recovery Time	$t_{rr}$	$I_F = I_R = 10mA,$ $I_{rr} = 0.1 \times I_R, R_L = 100\Omega$			6.0	ns
Capacitance Between Terminals	$C_T$	$V_R = 0V, f = 1MHz$			1.5	pF

**Absolute maximum rating@25°C**

Rating	Symbol	Value	Units
Reverse Voltage	$V_R$	70	V
Forward Current	$I_F$	200	mA
Non-Repetitive Peak Forward Surge Current @ $t=8.3ms$	$I_{FSM}$	2.0	A
Power Dissipation	$P_D$	225	mW
Thermal Resistance Junction to Ambient	$R_{\theta JA}$	556	$^{\circ}C/W$
Junction Temperature	$T_J$	150	$^{\circ}C$
Storage Temperature Rang	$T_{STG}$	-55 to +150	$^{\circ}C$

Typical Characteristics

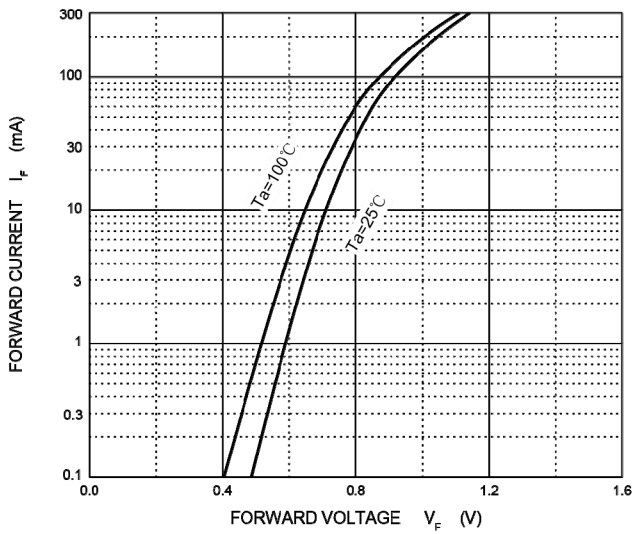

Fig 1 Forward Characteristics

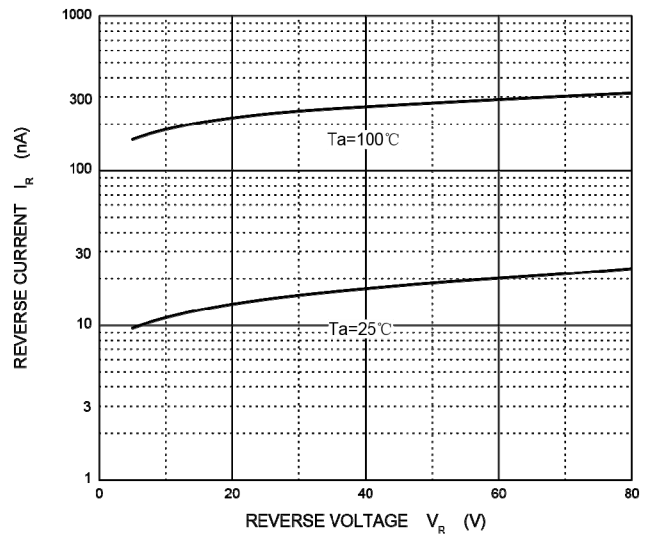

Fig 2 Reverse Characteristics

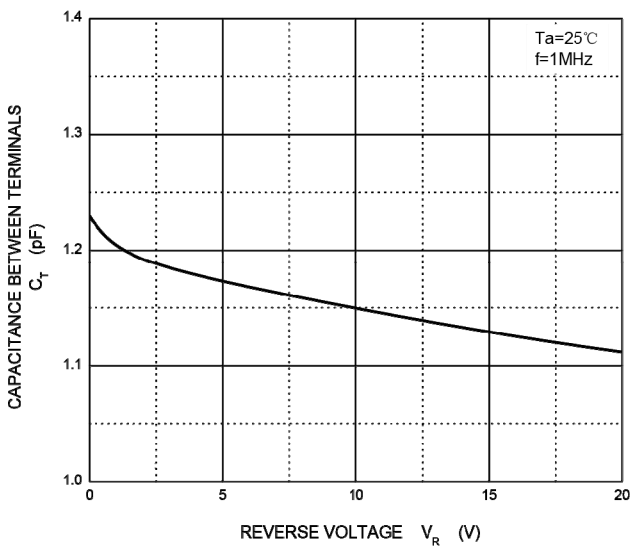

Fig 3 Capacitance Characteristics

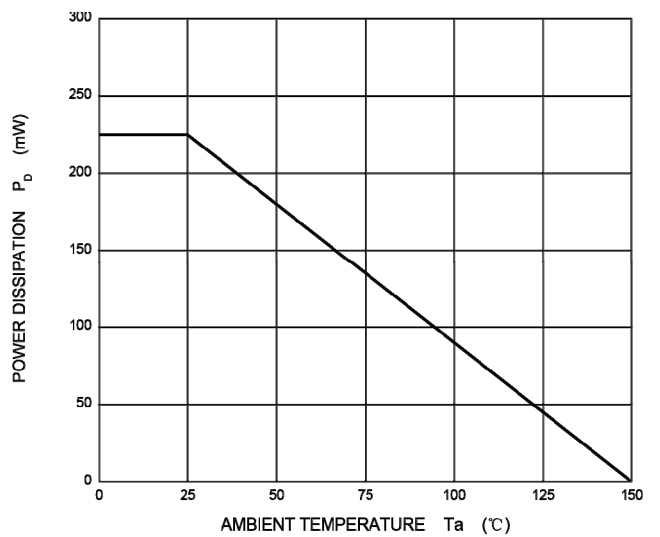
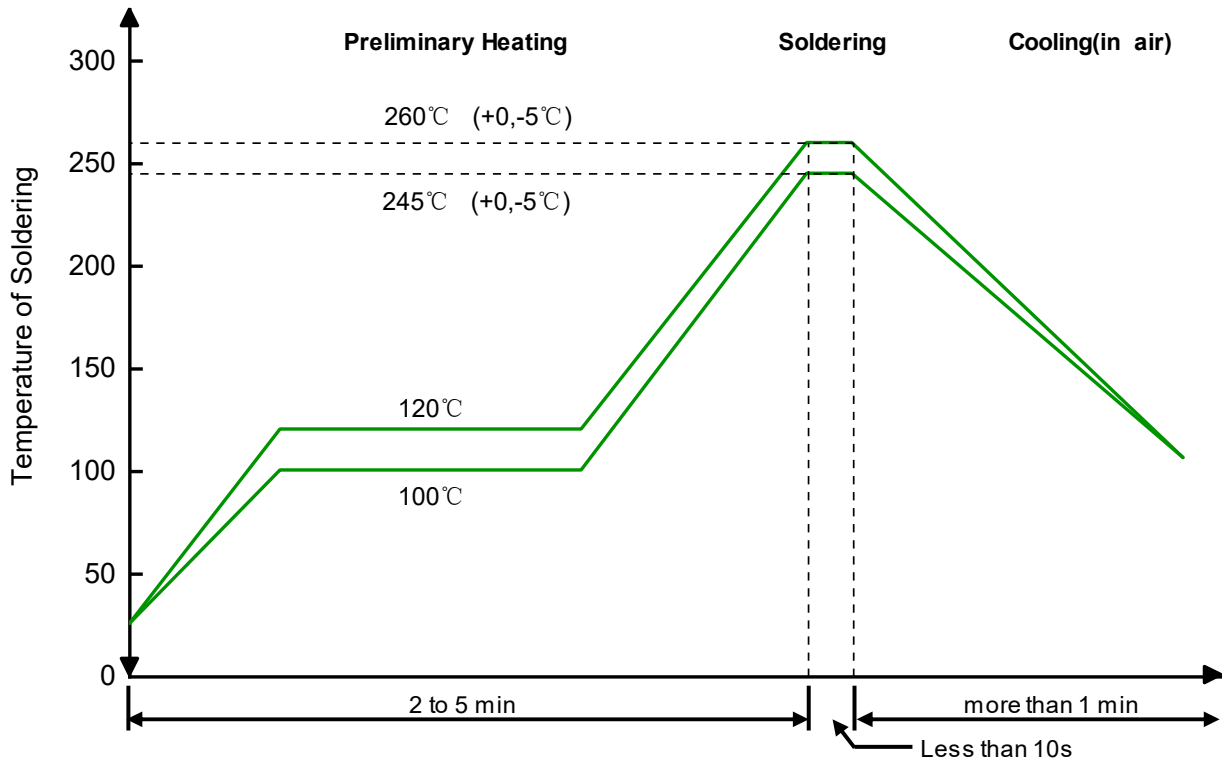

Fig 4 Power Derating Curve

Solder Reflow Recommendation



Remark: Pb free for 260°C; Pb for 245°C.

Ordering information

Device	Package	Shipping
BAV99LT1	SOT-23 (Pb-Free)	3000 / Tape & Reel

Marking information

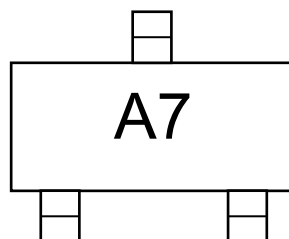

Product dimension(SOT-23)

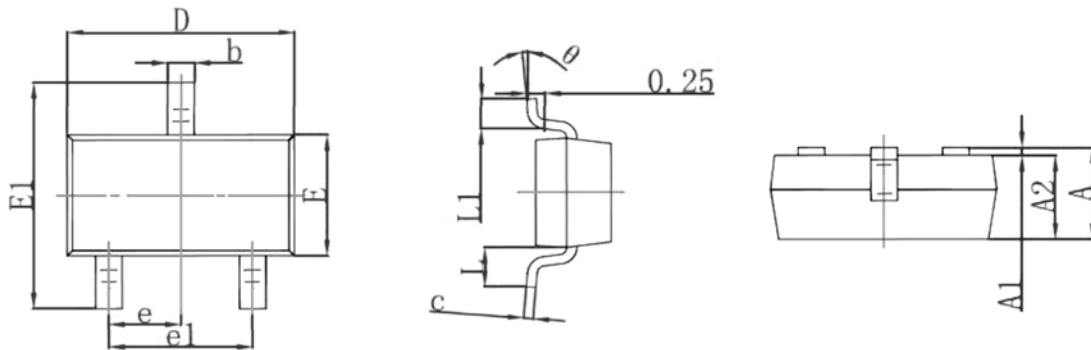

Dim	Millimeters		Inches	
	MIN	MAX	MIN	MAX
A	0.900	1.150	0.035	0.045
A1	0.000	0.100	0.000	0.004
A2	0.900	1.050	0.035	0.041
b	0.300	0.500	0.012	0.020
c	0.080	0.150	0.003	0.006
D	2.800	3.000	0.110	0.118
E	1.200	1.400	0.047	0.055
E1	2.250	2.550	0.089	0.100
e	0.950 Typ.		0.037 Typ.	
e1	1.800	2.000	0.071	0.079
L	0.550 Ref.		0.022 Ref.	
L1	0.300	0.500	0.012	0.020
θ	0°	8°	0°	8°

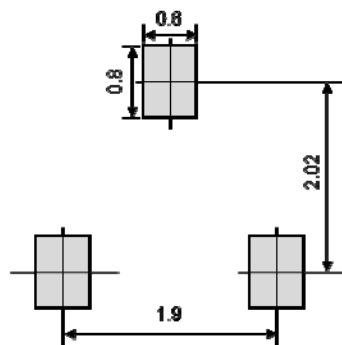

Suggested PCB Layout

Unit:mm

**IMPORTANT NOTICE**

 and **Prisemi**<sup>®</sup> are registered trademarks of **Prisemi Electronics Co., Ltd** (Prisemi). Prisemi reserves the right to make changes without further notice to any products herein. Prisemi makes no warranty, representation or guarantee regarding the suitability of its products for any particular purpose, nor does Prisemi assume any liability arising out of the application or use of any product or circuit, and specifically disclaims any and all liability, including without limitation special, consequential or incidental damages. “Typical” parameters which may be provided in Prisemi data sheets and/or specifications can and do vary in different applications and actual performance may vary over time. All operating parameters, including “Typicals” must be validated for each customer application by customer’s technical experts. Prisemi does not convey any license under its patent rights nor the rights of others. The products listed in this document are designed to be used with ordinary electronic equipment or devices, Should you intend to use these products with equipment or devices which require an extremely high level of reliability and the malfunction of with would directly endanger human life (such as medical instruments, aerospace machinery, nuclear-reactor controllers, fuel controllers and other safety devices), please be sure to consult with our sales representative in advance.

Website: <http://www.prisemi.com>

For additional information, please contact your local Sales Representative.

©Copyright 2009, Prisemi Electronics

 **Prisemi**<sup>®</sup> is a registered trademark of Prisemi Electronics.

All rights are reserved.