

GL Silicon N-Channel Power MOSFET

General Description:

The GLN4013AS-8 uses advanced trench technology and design to provide excellent RDS(ON) with low gate charge. It can be used in a wide variety of applications. The package form is SOP-8, which accords with the RoHS standard.

Features:

- Fast Switching
- Low Gate Charge and Rdson
- Low Reverse transfer capacitances
- 100% Single Pulse avalanche energy Test

Applications:

- PWM applications
- Load switch
- Power management

V _{DSS}	40	V
I _D	10	A
P _D	3.1	W
R _{DS(ON)type}	11	mΩ

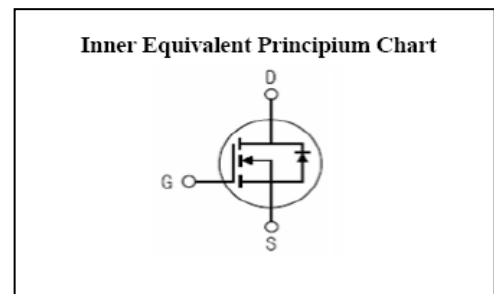
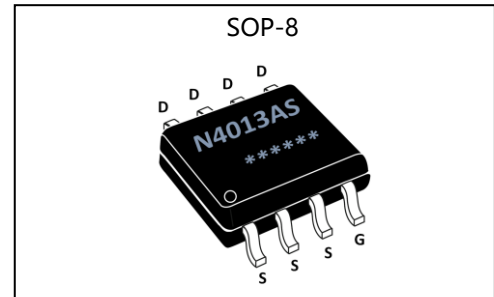

Absolute (T_c=25°C unless otherwise specified):

Symbol	Parameter	Rating	Units
V _{DSS}	Drain-to-Source Voltage	40	V
I _D	Continuous Drain Current	10	A
	Continuous Drain Current T _C = 70 °C	7	A
I _{DM} ^{A1}	Pulsed Drain Current	40	A
V _{GS}	Gate-to-Source Voltage	±20	V
E _{AS} ^{A2}	Single Pulse Avalanche Energy	80	mJ
dv/dt ^{A3}	Peak Diode Recovery dv/dt	5.0	V/ns
P _D	Power Dissipation	3.1	W
T _J , T _{stg}	Operating Junction and Storage Temperature Range	150, -55 to 150	°C
T _L	Maximum Temperature for Soldering	300	°C



GLN4013AS-8

无锡光磊电子科技有限公司

GL Silicon N-Channel Power MOSFET

Electrical Characteristics (Tc= 25°C unless otherwise specified) :

OFF Characteristics						
Symbol	Parameter	Test Conditions	Rating			Units
			Min.	Typ.	Max.	
V _{DSS}	Drain to Source Breakdown Voltage	V _{GS} =0V, I _D =-250μA	40	--	--	V
ΔBV _{DSS} /ΔT _J	BV _{DSS} Temperature Coefficient	I _D =250uA, Reference 25°C	--	0.1	--	V/°C
I _{DSS}	Drain to Source Leakage Current	V _{DS} =40, V _{GS} =0V, T _a =25°C	--	--	1	μA
		V _{DS} =40V, V _{GS} =0V, T _a =125°C	--	--	250	
I _{GSS(F)}	Gate to Source Forward Leakage	V _{GS} = +20V	--	--	1	μA
I _{GSS(R)}	Gate to Source Reverse Leakage	V _{GS} = -20V	--	--	-1	μA

ON Characteristics						
Symbol	Parameter	Test Conditions	Rating			Units
			Min.	Typ.	Max.	
R _{DS(ON)}	Drain-to-Source On-Resistance	V _{GS} =10V, I _D =10A	--	11	13	mΩ
V _{GS(TH)}	Gate Threshold Voltage	V _{DS} =V _{GS} , I _D =250μA	1.0	1.5	2.5	V
Pulse width tp ≤ 380μs, δ ≤ 2%						

Dynamic Characteristics						
Symbol	Parameter	Test Conditions	Rating			Units
			Min.	Typ.	Max.	
g _{fs}	Forward Transconductance	V _{DS} =5V, I _D =8A	33	--	--	S
C _{iss}	Input Capacitance	V _{GS} =0V, V _{DS} =20V f=1.0MHz	--	750	--	pF
C _{oss}	Output Capacitance		--	150	--	
C _{rss}	Reverse Transfer Capacitance		--	80	--	

Resistive Switching Characteristics						
Symbol	Parameter	Test Conditions	Rating			Units
			Min.	Typ.	Max.	
t _{d(ON)}	Turn-on Delay Time	I _D =2A, V _{DD} =20V V _{GS} =10V, R _G =3Ω, R _L =1Ω	--	6	--	ns
t _r	Rise Time		--	17	--	
t _{d(OFF)}	Turn-Off Delay Time		--	29	--	
t _f	Fall Time		--	17	--	
Q _g	Total Gate Charge	I _D =10A, V _{DD} =20V V _{GS} =10V	--	15	--	nC
Q _{gs}	Gate to Source Charge		--	3	--	
Q _{gd}	Gate to Drain ("Miller") Charge		--	2.5	--	

GL Silicon N-Channel Power MOSFET

Source-Drain Diode Characteristics						
Symbol	Parameter	Test Conditions	Rating			Units
			Min.	Typ.	Max.	
I_S	Continuous Source Current (Body Diode)		--	--	10	A
I_{SM}	Maximum Pulsed Current (Body Diode)		--	--	40	A
V_{SD}	Diode Forward Voltage	$I_S=10A, V_{GS}=0V$	--	--	1.2	V
t_{rr}	Reverse Recovery Time	$I_S=10A, T_j = 25^\circ C$	--	40	--	ns
Q_{rr}	Reverse Recovery Charge	$di_F/dt=100A/us, V_{GS}=0V$	--	21	--	nC

Pulse width $t_p \leq 380\mu s, \delta \leq 2\%$

Symbol	Parameter	Typ.	Units
$R_{\theta JA}$	Junction-to-Ambient	30	$^\circ C/W$

^{a1}: Repetitive rating; pulse width limited by maximum junction temperature

^{a3}: $I_{SD} = 10A, di/dt \leq 100A/us, V_{DD} \leq BV_{DS}, \text{Start } T_j = 25^\circ C$

Typical Electrical and Thermal Characteristics

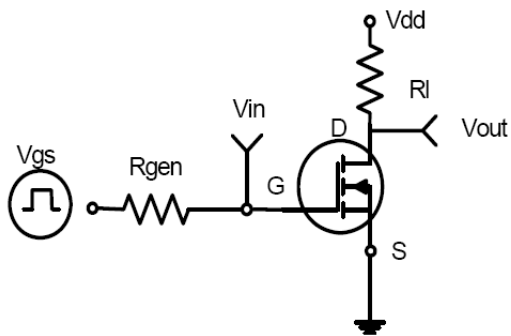

Figure 1: Switching Test Circuit

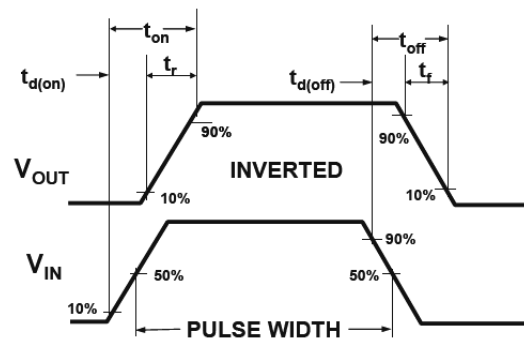

Figure 2: Switching Waveforms



GL Silicon N-Channel Power MOSFET

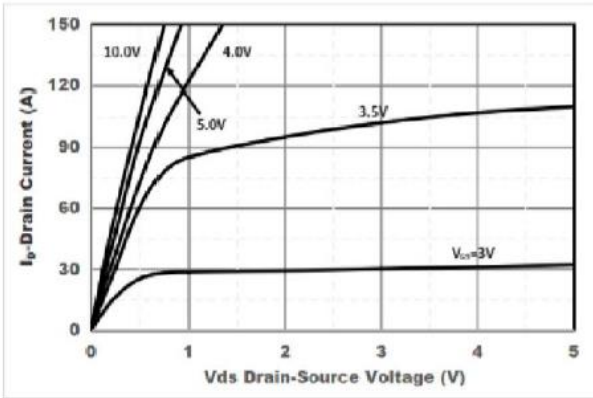

Figure1. Output Characteristics

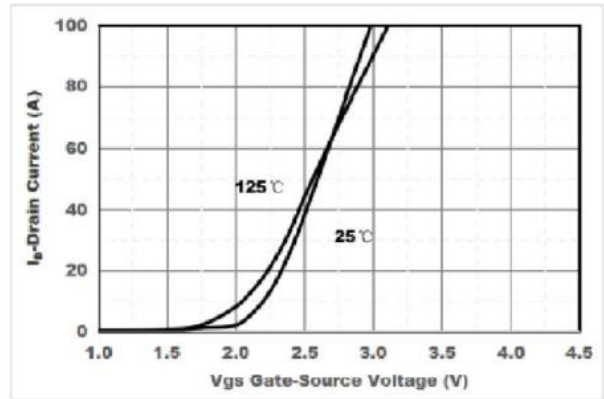

Figure2. Transfer Characteristics

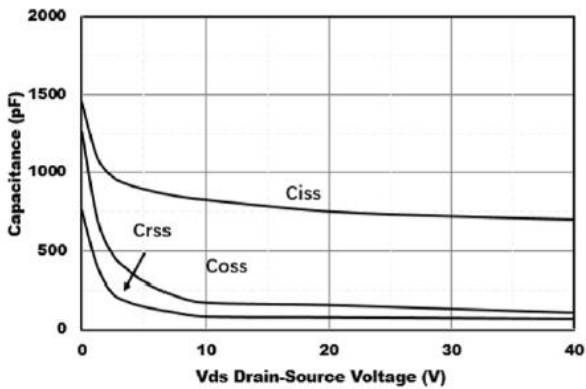

Figure3. Capacitance Characteristics

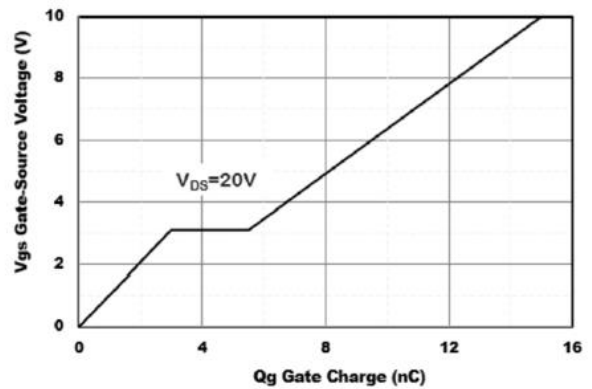

Figure4. Gate Charge

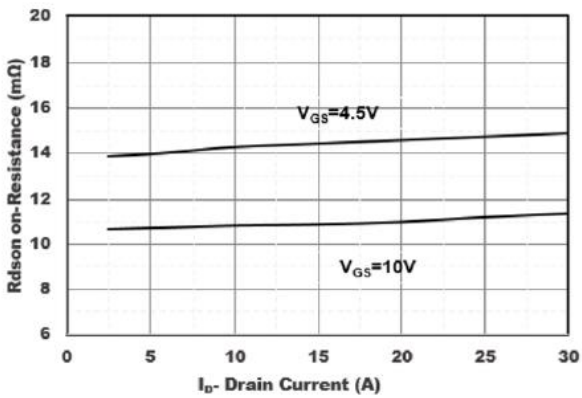

Figure5. Drain-Source on Resistance

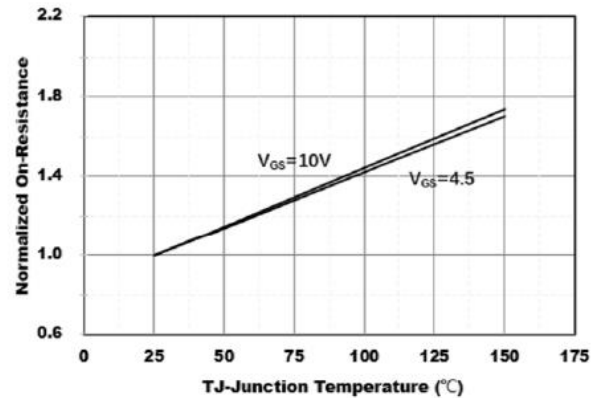

Figure6. Drain-Source on Resistance



GLN4013AS-8

无锡光磊电子科技有限公司

GL Silicon N-Channel Power MOSFET

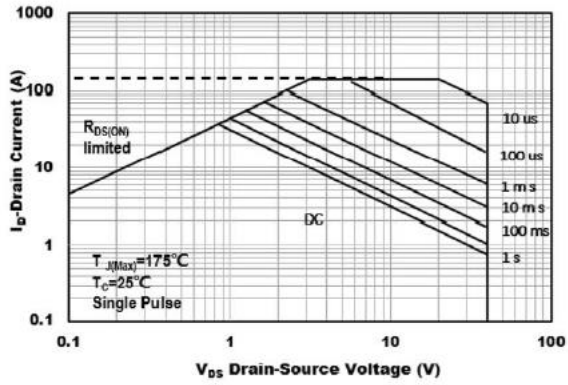

Figure7. Safe Operation Area

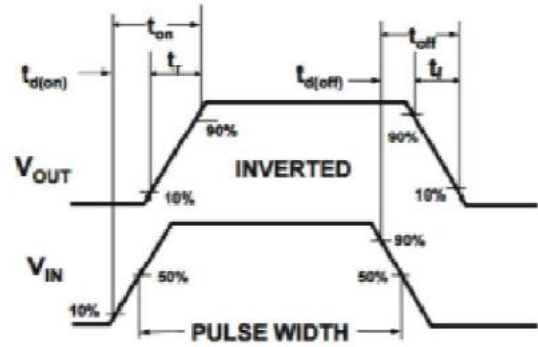

Figure8. Switching wave

TEL:0755-23068119