

## Dual N-Channel High Density Trench MOSFET (20V, 7A)

PRODUCT SUMMARY		
$V_{DSS}$	$I_D$	$R_{DS(on)}$ (m $\Omega$ ) Max
20V	7A	20 @ $V_{GS} = 10V, I_D = 7A$
		24 @ $V_{GS} = 4.5V, I_D = 6.5A$
		32 @ $V_{GS} = 2.5V, I_D = 5.5A$

### Features

- Super high dense cell trench design for low  $R_{DS(on)}$
- Rugged and reliable
- Surface Mount package
- Battery Switch ESD Protected 2KV
- Ordering information: GM8820E -G (Lead(Pb)-free and halogen-free)

RoHS+HF

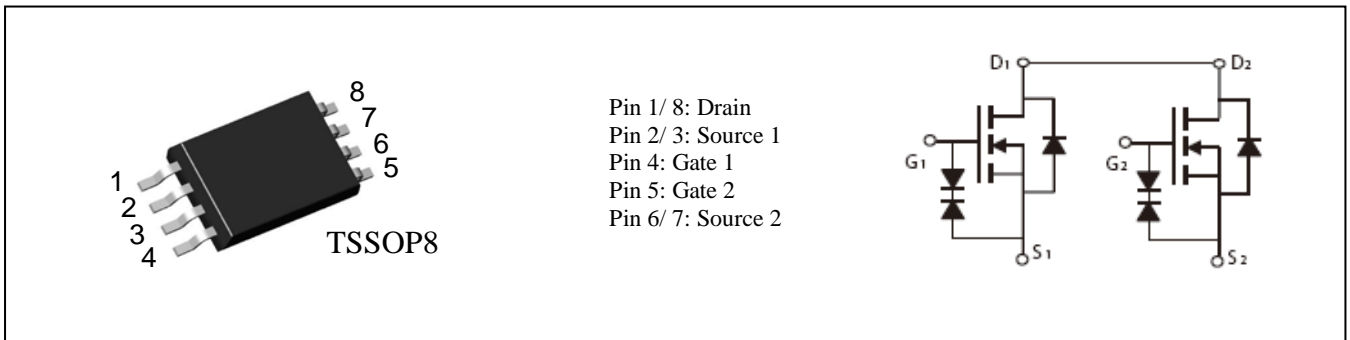

### Absolute Maximum Ratings ( $T_A = 25^\circ\text{C}$ , unless otherwise noted)

Symbol	Parameter	Ratings	Units
$V_{DS}$	Drain-Source Voltage	20	V
$V_{GS}$	Gate-Source Voltage	$\pm 12$	V
$I_D$	Drain Current (Continuous)	7	A
$I_{DM}$	Drain Current (Pulsed) <sup>a</sup>	30	A
$P_D$	Total Power Dissipation @ $T_A = 25^\circ\text{C}$	1.5	W
$T_j, T_{stg}$	Operating Junction and Storage Temperature Range	-55 to +150	$^\circ\text{C}$
$R_{\theta JA}$	Thermal Resistance Junction to Ambient (PCB mounted) <sup>b</sup>	83	$^\circ\text{C/W}$

Note: a: Repetitive Rating; Pulse width limited by the maximum junction temperature

b: 1-in<sup>2</sup> 2oz Cu PCB board

## Electrical Characteristics (T<sub>A</sub>=25°C, unless otherwise noted)

Symbol	Characteristic	Test Conditions	Min.	Typ.	Max.	Unit
<b>• Off Characteristics</b>						
BV <sub>DSS</sub>	Drain-Source Breakdown Voltage	V <sub>GS</sub> =0V, I <sub>D</sub> =250μA	20	-	-	V
I <sub>DSS</sub>	Zero Gate Voltage Drain Current	V <sub>DS</sub> =16V, V <sub>GS</sub> =0V	-	-	1	μA
I <sub>GSS</sub>	Gate-Body Leakage Current	V <sub>GS</sub> =±12V, V <sub>DS</sub> =0V	-	-	±10	uA
<b>• On Characteristics<sup>c</sup></b>						
V <sub>GS(th)</sub>	Gate Threshold Voltage	V <sub>DS</sub> =V <sub>GS</sub> , I <sub>D</sub> =250μA	0.5	-	1.0	V
R <sub>DS(on)</sub>	Drain-Source On-State Resistance	V <sub>GS</sub> =10V, I <sub>D</sub> =7A	-	16	20	mΩ
		V <sub>GS</sub> =4.5V, I <sub>D</sub> =6.5A	-	20	24	
		V <sub>GS</sub> =2.5V, I <sub>D</sub> =5.5A	-	26	32	
g <sub>FS</sub>	Forward Transconductance	V <sub>DS</sub> =10V, I <sub>D</sub> =6.5A	-	19	-	S
<b>• Dynamic Characteristics<sup>d</sup></b>						
C <sub>iss</sub>	Input Capacitance	V <sub>DS</sub> =10V, V <sub>GS</sub> =0V, f=1MHz	-	321	-	pF
C <sub>oss</sub>	Output Capacitance		-	101	-	
C <sub>rss</sub>	Reverse Transfer Capacitance		-	24	-	
<b>• Switching Characteristics<sup>d</sup></b>						
Q <sub>g</sub>	Total Gate Charge	V <sub>DS</sub> =12V, I <sub>D</sub> =6A, V <sub>GS</sub> =4.5V	-	9.2	-	nC
Q <sub>gs</sub>	Gate-Source Charge		-	2.7	-	
Q <sub>gd</sub>	Gate-Drain Charge		-	3.7	-	
t <sub>d(on)</sub>	Turn-on Delay Time	V <sub>DD</sub> =10V, R <sub>L</sub> =5Ω, I <sub>D</sub> =2A, V <sub>GS</sub> =4.5V, R <sub>GEN</sub> =6Ω	-	307	-	nS
t <sub>r</sub>	Turn-on Rise Time		-	725	-	
t <sub>d(off)</sub>	Turn-off Delay Time		-	3492	-	
t <sub>f</sub>	Turn-off Fall Time		-	2135	-	
<b>• Drain-Source Diode Characteristics</b>						
V <sub>SD</sub>	Drain-Source Diode Forward Voltage	V <sub>GS</sub> =0V, I <sub>S</sub> =1A	-	-	1	V

Note: c : Pulse Test : Pulse Width < 300μs, Duty Cycle < 2%

d: Guaranteed by design, not subject to production testing.

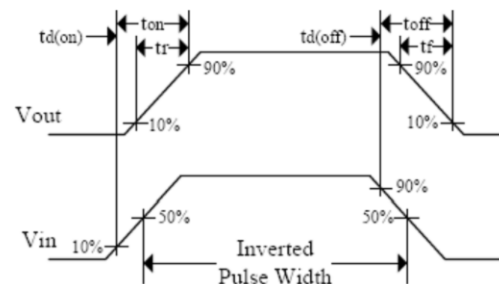
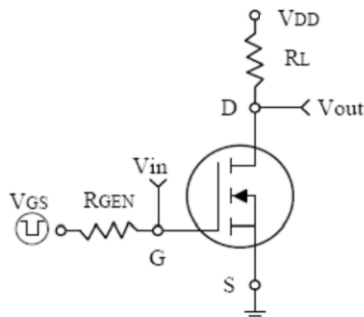

Switching Test Circuit and Switching Waveforms

## Characteristics Curve

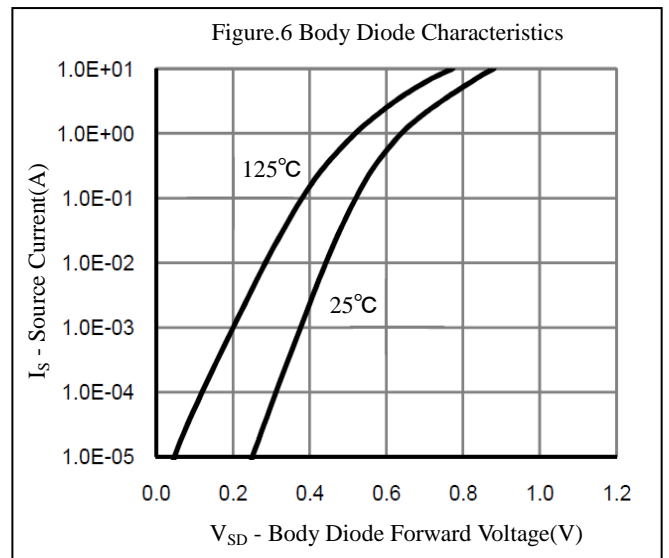
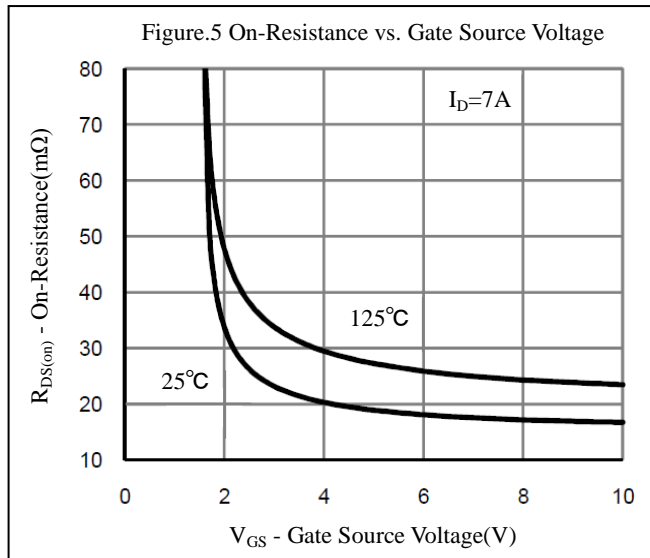
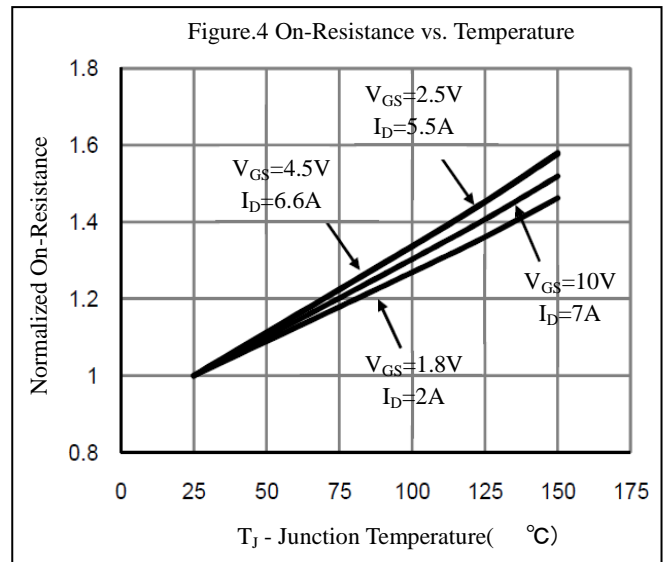
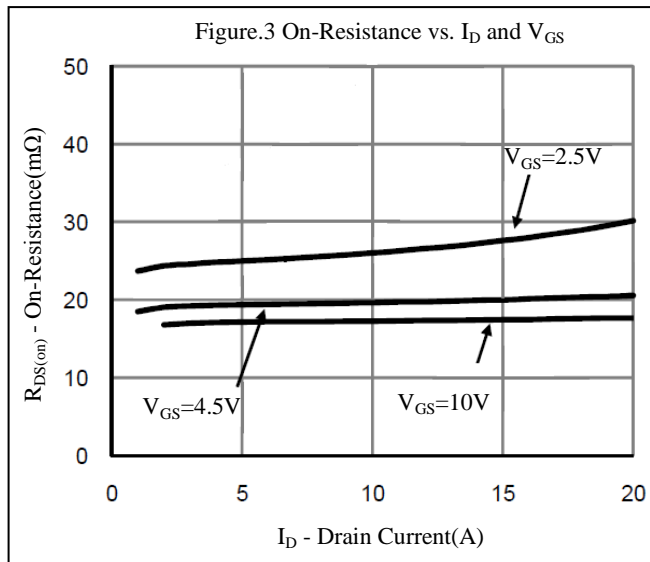
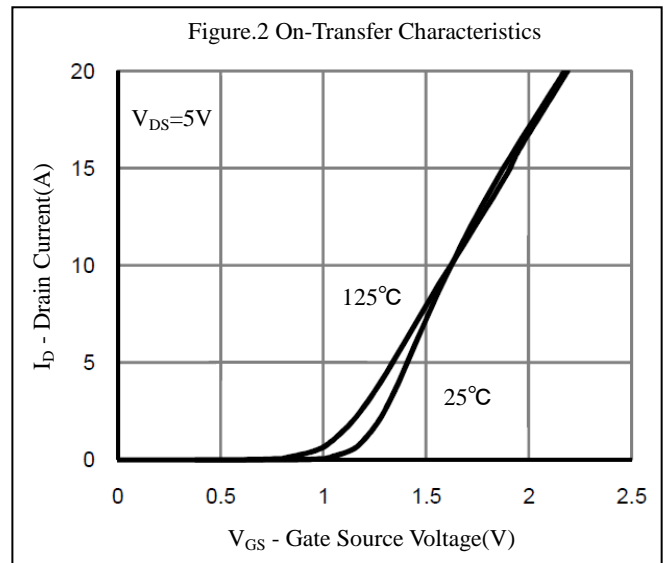
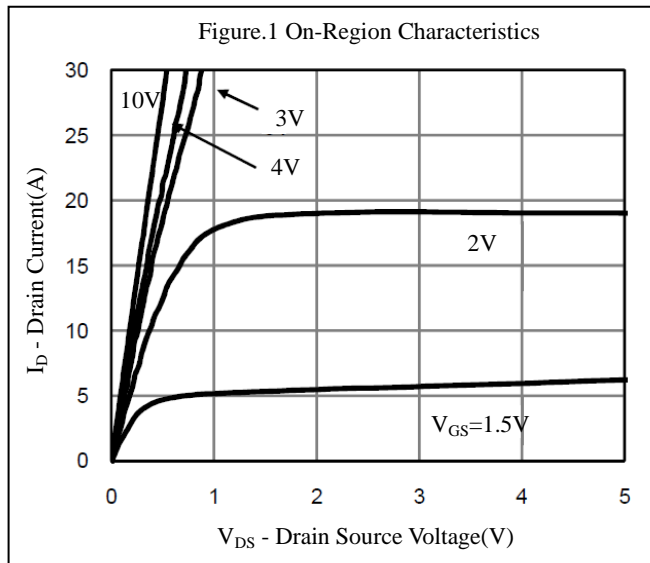

## Characteristics Curve

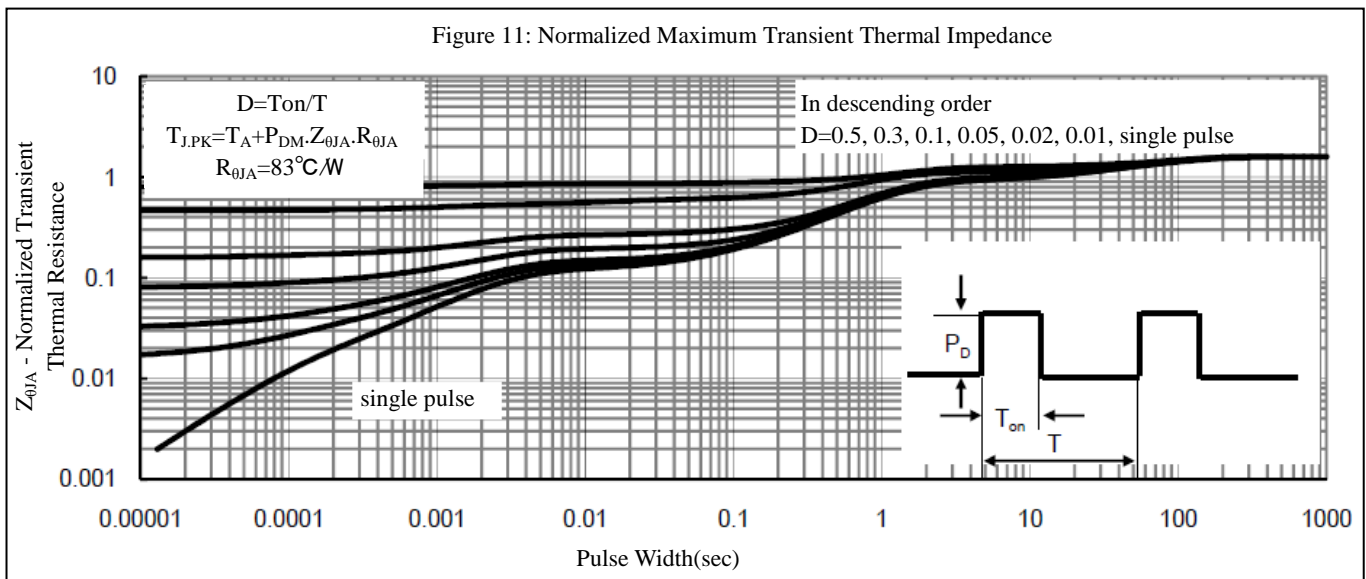
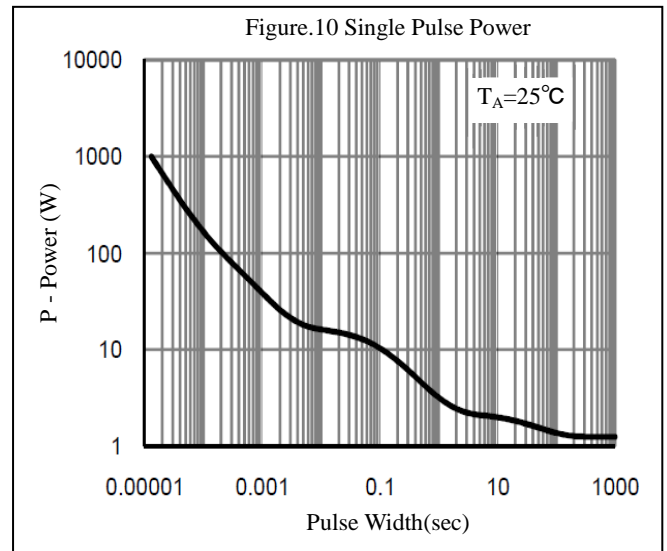
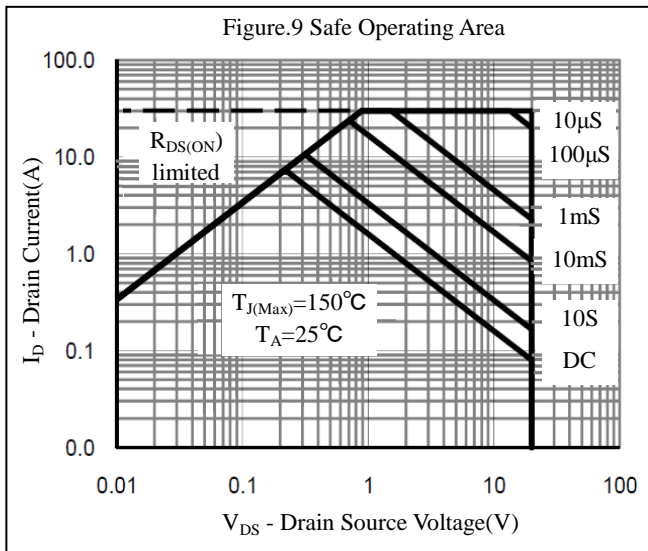
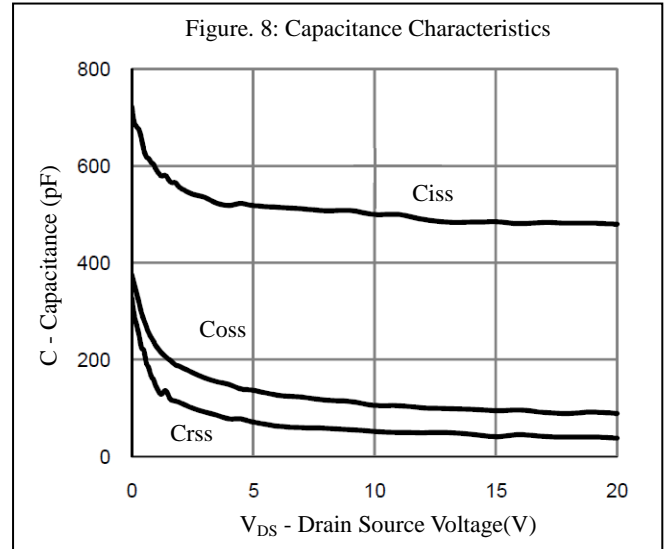
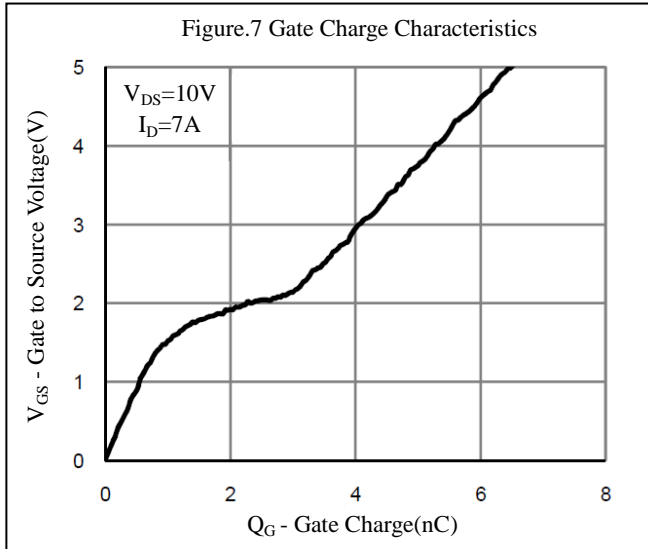

## TSSOP8 PACKAGE OUTLINE DIMENSIONS

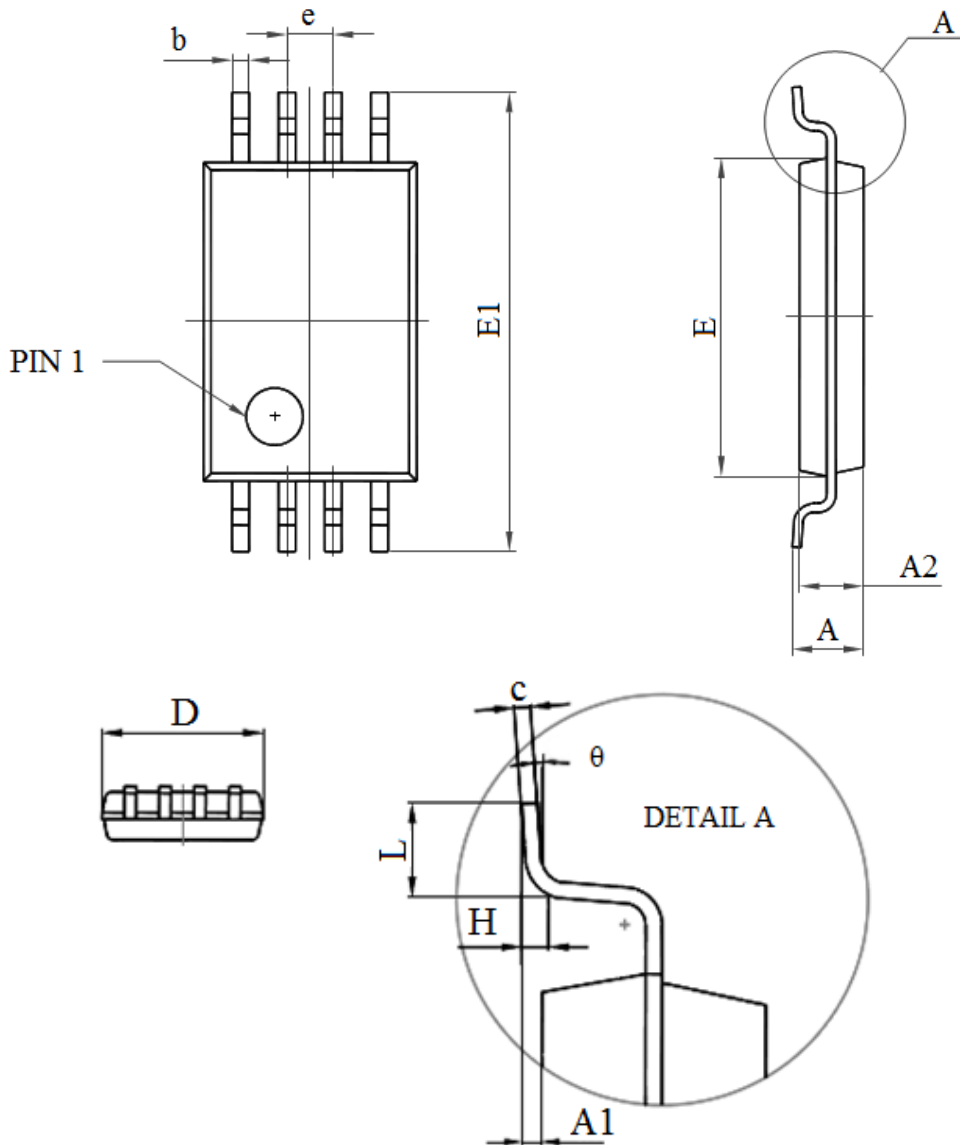

Symbol	Dimensions In Millimeters(MM)		Dimensions In Inches(MIL)	
	Min	Max	Min	Max
D	2.900	3.160	0.114	0.124
E	4.300	4.500	0.169	0.177
b	0.190	0.300	0.007	0.012
c	0.090	0.200	0.004	0.008
E1	6.250	6.550	0.246	0.258
A		1.200		0.047
A2	0.800	1.000	0.031	0.039
A1	0.050	0.150	0.002	0.006
e	0.65(BSC)		0.026(BSC)	
L	0.500	0.700	0.020	0.028
H	0.25(TYP)		0.01(TYP)	
θ	1°	7°	1°	7°



Notice

1. Specification of the products displayed herein is subject to change without notice. Continuous development may necessitate changes in technical data without notice. GEMMICRO or anyone on its behalf assumes no responsibility or liability for any errors or inaccuracies.
2. Stresses beyond those listed under “Absolute Maximum Ratings” may cause permanent damage to the device. These are stress ratings only and functional operation of the device at these or any other conditions beyond those indicated in the operational sections of the specifications are not implied. Exposure to absolute maximum rating conditions for extended periods may affect device reliability.