

Intelligent Power Module (IPM) 1200 V, 20 A



ON Semiconductor®

www.onsemi.com

Advance Information NFAM2012L5BT

The NFAM2012L5BT is a fully-integrated inverter power module consisting of an independent High side gate driver, LVIC, six IGBT's and a temperature sensor (TSU by LVIC and NTC Thermistor), suitable for driving permanent magnet synchronous (PMSM) motors, brushless DC (BLDC) motors and AC asynchronous motors. The IGBT's are configured in a three-phase bridge with separate emitter connections for the lower legs for maximum flexibility in the choice of control algorithm.

The power stage has under-voltage lockout protection (UVP). Internal boost diodes are provided for high side gate boost drive.

Features

- Three-phase 1200 V, 20 A IGBT Module with Independent Drivers
- Active Logic Interface
- Built-in Under-voltage Protection (UVP)
- Integrated Bootstrap Diodes and Resistors
- Separate Low-side IGBT Emitter Connections for Individual Current Sensing of Each Phase
- Temperature Sensor (TSU Output by LVIC or NTC Thermistor)
- UL Certification: *Applied
- This is a Pb-Free Device

Typical Application

- Industrial Drives
- Industrial Pumps
- Industrial Fans
- Industrial Automation

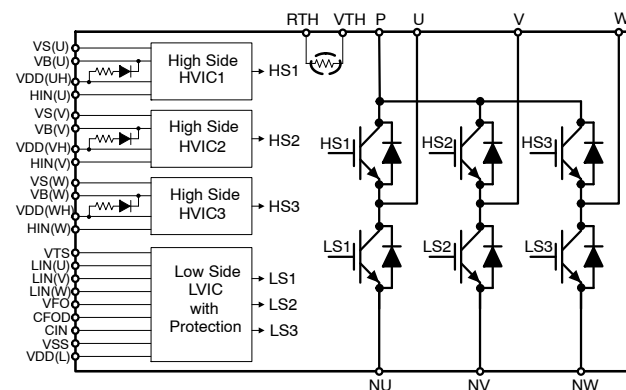
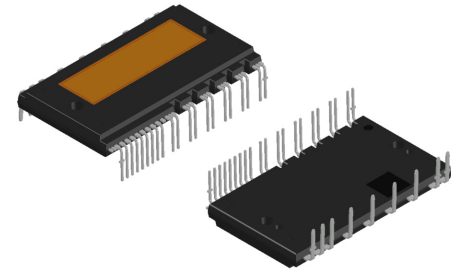

Figure 1. Application Schematic

This document contains information on a new product. Specifications and information herein are subject to change without notice.



CASE MODGC
MINI DIP39, 31.0x54.5

MARKING DIAGRAM



NFAM2012L5BT = Specific Device Code
 ZZZ = Assembly Lot Code
 A = Assembly Location
 T = Test Location
 Y = Year
 WW = Work Week
 Device marking is on package top side

ORDERING INFORMATION

Device	Package	Shipping† (Qty / Packing)
NFAM2012L5BT	DIP39, 31.0x54.5 (Pb-Free)	90 / BOX

†For information on tape and reel specifications, including part orientation and tape sizes, please refer to our Tape and Reel Packaging Specification Brochure, BRD8011/D.

NFAM2012L5BT

Table 1. PIN FUNCTION DESCRIPTION

Pin	Name	Description
1	VS(U)	High-Side Bias Voltage GND for U Phase IGBT Driving
(2)	-	Dummy
3	VB(U)	High-Side Bias Voltage for U Phase IGBT Driving
4	VDD(UH)	High-Side Bias Voltage for U Phase IC
(5)	-	Dummy
6	HIN(U)	Signal Input for High-Side U Phase
7	VS(V)	High-Side Bias Voltage GND for V Phase IGBT Driving
(8)	-	Dummy
9	VB(V)	High-Side Bias Voltage for V Phase IGBT Driving
10	VDD(VH)	High-Side Bias Voltage for V Phase IC
(11)	-	Dummy
12	HIN(V)	Signal Input for High-Side V Phase
13	VS(W)	High-Side Bias Voltage GND for W Phase IGBT Driving
(14)	-	Dummy
15	VB(W)	High-Side Bias Voltage for W Phase IGBT Driving
16	VDD(WH)	High-Side Bias Voltage for W Phase IC
(17)	-	Dummy
18	HIN(W)	Signal Input for High-Side W Phase
(19)	-	Dummy
20	VTS	Voltage Output for LVIC Temperature Sensing Unit
21	LIN(U)	Signal Input for Low-Side U Phase
22	LIN(V)	Signal Input for Low-Side V Phase
23	LIN(W)	Signal Input for Low-Side W Phase
24	VFO	Fault Output
25	CFOD	Capacitor for Fault Output Duration Selection
26	CIN	Input for Current Protection
27	VSS	Low-Side Common Supply Ground
28	VDD(L)	Low-Side Bias Voltage for IC and IGBTs Driving
(29)	-	Dummy
(30)	-	Dummy
31	NW	Negative DC-Link Input for U Phase
32	NV	Negative DC-Link Input for V Phase
33	NU	Negative DC-Link Input for W Phase
34	W	Output for U Phase
35	V	Output for V Phase
36	U	Output for W Phase
37	P	Positive DC-Link Input
38	VTH	Thermistor Bias Voltage (T) / Not connection
39	RTH	Series Resistor for Thermistor (Temperature Detection) *optional for T

NFAM2012L5BT

Table 2. ABSOLUTE MAXIMUM RATINGS $T_C = 25^\circ\text{C}$ (Notes 1)

Rating	Symbol	Conditions	Value	Unit
Supply Voltage	VPN	P – NU, NV, NW	900	V
Supply Voltage (Surge)	VPN(Surge)	P – NU, NV, NW, (Note 2)	1000	V
Self Protection Supply Voltage Limit (Short-Circuit Protection Capability)	VPN(PROT)	VDD = VBS = 13.5 V ~ 16.5 V, Ti = 150°C, Vces < 1200 V, Non-Repetitive, < 2 us	800	V
Collector-Emitter Voltage	Vces		1200	V
Maximum Repetitive Revers Voltage	VRRM		1200	V
Each IGBT Collector Current	$\pm I_c$		± 20	A
Each IGBT Collector Current (Peak)	$\pm I_{cp}$	Under 1 ms Pulse Width	± 40	A
Control Supply Voltage High-Side Control Bias Voltage	VDD	VDD(UH, VH, WH), VDD(L) – VSS	-0.3 to 20	V
	VBS	VB(U) – VS(U), VB(V) – VS(V), VB(W) – VS(W)	-0.3 to 20	V
Input Signal Voltage	VIN	HIN(U), HIN(V), HIN(W), LIN(U), LIN(V), LIN(W) – VSS	-0.3 to VDD	V
Fault Output Supply Voltage	VFO	VFO – VSS	-0.3 to VDD	V
Fault Output Current	IFO	Sink Current at VFO pin	2	mA
Current Sensing Input Voltage	VCIN	CIN – VSS	-0.3 to VDD	V
Corrector Dissipation	Pc	Per One Chip	125	W
Operating Junction Temperature	Tj		-40 to +150	°C
Storage Temperature	Tstg		-40 to +125	°C
Module Case Operation Temperature	Tc		-40 to +125	°C
Isolation Voltage	Viso	60 Hz, Sinusoidal, AC 1 minute, Connection Pins to Heat Sink Plate	2500	V rms

Stresses exceeding those listed in the Maximum Ratings table may damage the device. If any of these limits are exceeded, device functionality should not be assumed, damage may occur and reliability may be affected.

1. Refer to ELECTRICAL CHARACTERISTICS, RECOMMENDED OPERATING RANGES and/or APPLICATION INFORMATION for Safe Operating parameters.
2. This surge voltage developed by the switching operation due to the wiring inductance between P and NU, NV, NW terminal.

Table 3. THERMAL CHARACTERISTICS

Rating	Symbol	Conditions	Min	Typ	Max	Unit
Junction to Case Thermal Resistance	Rth(j-c)Q	Inverter IGBT Part (per 1/6 Module)	-	-	1.0	°C/W
	Rth(j-c)F	Inverter FRD Part (per 1/6 Module)	-	-	1.2	°C/W

3. Refer to ELECTRICAL CHARACTERISTICS, RECOMMENDED OPERATING RANGES and/or APPLICATION INFORMATION for Safe Operating parameters.

Table 4. RECOMMENDED OPERATING RANGES (Note 4) (continued)

Rating	Symbol	Conditions	Min	Typ	Max	Unit
Supply Voltage	VPN	P – NU, NV, NW	-	600	800	V
Gate Driver Supply Voltages	VDD	VDD(UH, VH, WH), VDD(L) – VSS	13.5	15	16.5	V
	VBS	VB(U) – VS(U), VB(V) – VS(V), VB(W) – VS(W)	13.0	15	18.5	V
Supply Voltage Variation	dVDD / dt dVBS / dt		-1	-	1	V/ μ s
PWM Frequency	fPWM		1		20	kHz
Dead Time	DT	Turn-off to Turn-on (external)	3	-	-	μ s

NFAM2012L5BT

Table 4. RECOMMENDED OPERATING RANGES (Note 4) (continued)

Rating	Symbol	Conditions	Min	Typ	Max	Unit	
Allowable r.m.s. Current	I _o	V _{PN} = 600 V, V _{DD} = V _{BS} = 15 V, P.F. = 0.8, T _c ≤ 125°C, T _j ≤ 150°C, (Note 5)	fPWM = 5 kHz	–	–	18.1	A rms
			fPWM = 15 kHz	–	–	9.4	
Allowable Input Pulse Width	PWIN (on)	400 V ≤ V _{PN} ≤ 800 V, 13.5 V ≤ V _{DD} ≤ 16.5 V, 13.0 V ≤ V _{BS} ≤ 18.5 V, –40°C ≤ T _c ≤ 150°C	2.0	–	–	μs	
	PWIN (off)		2.5	–	–		
Package Mounting Torque		M3 Type Screw	0.6	0.7	0.9	Nm	

Functional operation above the stresses listed in the Recommended Operating Ranges is not implied. Extended exposure to stresses beyond the Recommended Operating Ranges limits may affect device reliability.

4. Allowable r.m.s Current depends on the actual conditions.
5. Flatness tolerance of the heatsink should be within –50 μm to +100 μm.

Table 5. ELECTRICAL CHARACTERISTICS (T_c = 25°C, V_D = 15 V, unless otherwise noted) (Note 6) (continued)

Parameter		Test Conditions	Symbol	Min	Typ	Max	Unit
INVERTER SECTION							
Collector–Emitter Leakage Current	V _{ce} = V _{ces} , T _j = 25°C		I _{ces}	–	–	1	mA
	V _{ce} = V _{ces} , T _j = 150°C			–	–	10	mA
Collector–Emitter Saturation Voltage	V _{DD} = V _{BS} = 15 V, I _N = 5 V I _c = 20 A, T _j = 25°C		V _{CE(sat)}	–	1.85	2.5	V
	V _{DD} = V _{BS} = 15 V, I _N = 5 V I _c = 20 A, T _j = 150°C			–	2.00	–	V
FWDI Forward Voltage	I _N = 0 V, I _f = 20 A, T _j = 25°C		V _F	–	1.90	2.5	V
	I _N = 0 V, I _f = 20 A, T _j = 150°C			–	1.70	–	V
High Side	Switching Times	V _{PN} = 600 V, V _{DD(H)} = V _{DD(L)} = 15 V I _c = 20 A, T _j = 25°C, I _N = 0 ↔ 5 V Inductive Load	ton	0.80	1.40	2.00	μs
			tc (on)	–	0.30	0.60	μs
			toff	–	1.90	2.70	μs
			tc (off)	–	0.20	0.60	μs
			trr	–	0.40	–	μs
Low Side	Switching Times	V _{PN} = 600 V, V _{DD(H)} = V _{DD(L)} = 15 V I _c = 20 A, T _j = 25°C, I _N = 0 ↔ 5 V Inductive Load	ton	0.90	1.50	2.10	μs
			tc (on)	–	0.30	0.60	μs
			toff	–	2.00	2.80	μs
			tc (off)	–	0.20	0.60	μs
			trr	–	0.40	–	μs
DRIVER SECTION							
Quiescent VDD Supply Current	V _{DD(UH,VH,WH)} = 15 V, H _{IN(U,V,W)} = 0 V	V _{DD(UH)} – V _{SS} V _{DD(VH)} – V _{SS} V _{DD(WH)} – V _{SS}	I _{QDDH}	–	–	0.30	mA
	V _{DD(L)} = 15 V, L _{IN(U, V, W)} = 0 V	V _{DD(L)} – V _{SS}	I _{QDDL}	–	–	3.50	mA
Operating VDD Supply Current	V _{DD(UH, VH, WH)} = 15 V, fPWM = 20 kHz, Duty = 50%, Applied to one PWM Signal Input for High–Side	V _{DD(UH)} – V _{SS} V _{DD(VH)} – V _{SS} V _{DD(WH)} – V _{SS}	I _{PDDH}	–	–	0.40	mA
	V _{DD(L)} = 15 V, fPWM = 20 kHz, Duty = 50%, Applied to one PWM Signal Input for Low–Side	V _{DD(L)} – V _{SS}	I _{PDDL}	–	–	9.00	mA

NFAM2012L5BT

Table 5. ELECTRICAL CHARACTERISTICS (Tc = 25°C, VD = 15 V, unless otherwise noted) (Note 6) (continued)

Parameter	Test Conditions	Symbol	Min	Typ	Max	Unit
DRIVER SECTION						
Quiescent VBS Supply Current	VBS = 15 V HIN(U, V, W) = 0 V	VB(U) – VS(U) VB(V) – VS(V) VB(W) – VS(W)	IQBS	–	–	0.30 mA
Operating VBS Supply Current	VDD = VBS = 15 V, fPWM = 20 kHz, Duty = 50%, Applied to one PWM Signal Input for High-Side	VB(U) – VS(U) VB(V) – VS(V) VB(W) – VS(W)	IPBS	–	–	8.00 mA
ON Threshold Voltage	HIN(U, V, W) – VSS, LIN(U, V, W) – VSS	VIN(ON)	–	–	2.6	V
OFF Threshold Voltage		VIN(OFF)	0.8	–	–	V
Short Circuit Trip Level	VDD = 15 V, CIN–VSS	VCIN(ref)	0.46	0.48	0.50	V
Supply Circuit Under-Voltage Protection	Detection Level	UVDDD	10.3	–	12.5	V
	Reset Level	UVDDR	10.8	–	13.0	V
	Detection Level	UVBSD	10.0	–	12.0	V
	Reset Level	UVBSR	10.5	–	12.5	V
Voltage Output for LVIC Temperature Sensing Unit	VTS–VSS = 10 nF, Temp. = 25°C	VTS	(0.905)	(1.030)	(1.155)	V
Fault Output Voltage	VDD = 0 V, CIN = 0 V, VFO Circuit: 10 kΩ to 5 V Pull-up	VFOH	4.9	–	–	V
	VDD = 0 V, CIN = 1 V, VFO Circuit: 10 kΩ to 5 V Pull-up	VFOL	–	–	0.95	V
Fault-Output Pulse Width	CFOD = 22 nF	tFOD	1.6	2.4	–	ms
BOOTSTRAP SECTION						
Bootstrap Diode Forward Current	If = 0.1 A	VF	3.4	4.6	5.8	V
Built-in Limiting Resistance		RBOOT	30	38	46	Ω

Product parametric performance is indicated in the Electrical Characteristics for the listed test conditions, unless otherwise noted. Product performance may not be indicated by the Electrical Characteristics if operated under different conditions.

- Performance guaranteed over the indicated operating temperature range by design and/or characterization tested at T_J = T_A = 25°C. Low duty cycle pulse techniques are used during testing to maintain the junction temperature as close to ambient as possible.
- The fault-out pulse width tFOD depends on the capacitance value of CFOD according to the following approximate equation:
tFOD = (TBD) × 10⁶ × CFOD (s).
- Values based on design and/or characterization.

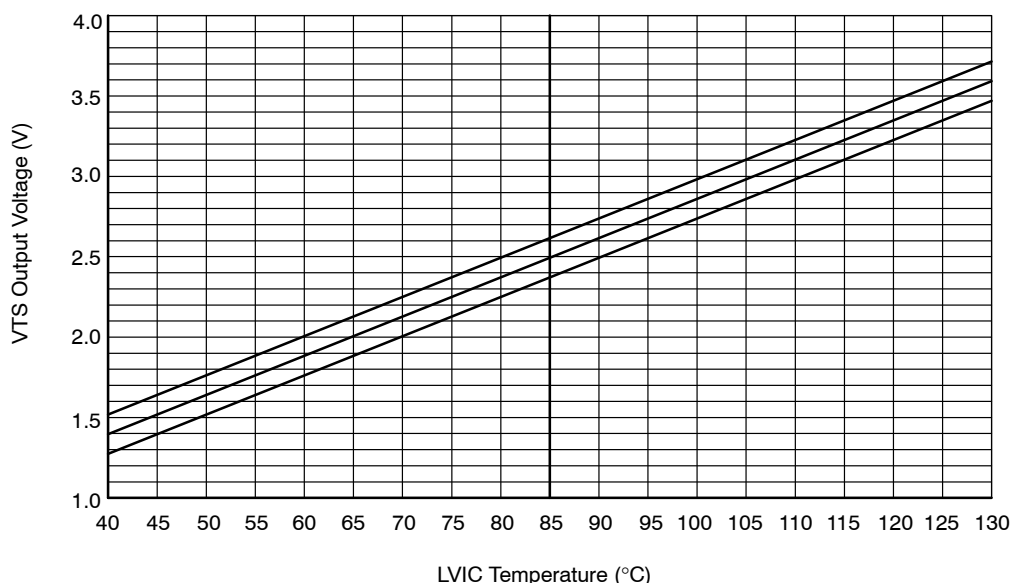

Figure 4. Temperature of LVIC versus VOT Characteristics

Table 6. THERMISTOR CHARACTERISTIC

Parameter	Symbol	Condition	Min	Typ	Max	Unit
Resistance	R ₂₅	T _c = 25°C	46.530	47	47.47	kΩ
Resistance	R ₁₂₅	T _c = 125°C	1.344	1.406	1.471	kΩ
B-Constant (25-50°C)	-	B	4009.5	4050	4090.5	K
Temperature Range	-	-	-40	-	+125	°C

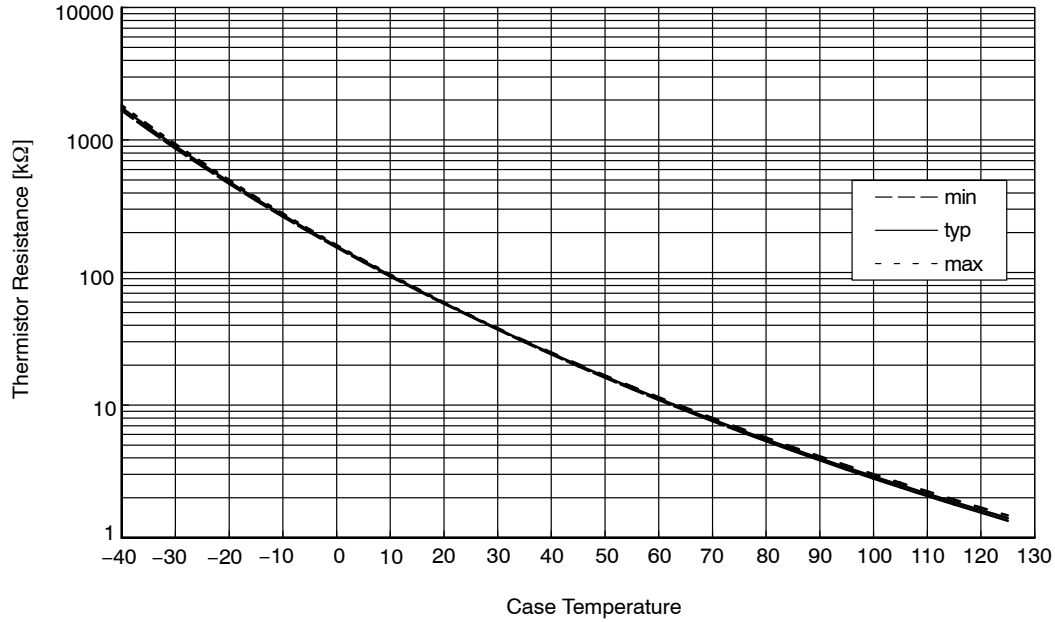
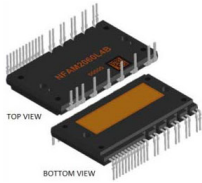

Figure 5. Thermistor Resistance versus Case Temperature

MECHANICAL CASE OUTLINE

PACKAGE DIMENSIONS

ON Semiconductor®



MINI DIP39, 31.0x54.5 CASE MODGC ISSUE A

DATE 19 MAR 2019

NOTES:

1. DIMENSIONING AND TOLERANCING PER ASME Y14.5M, 2009.
2. CONTROLLING DIMENSION: MILLIMETERS
3. DIMENSION *b* and *c* APPLY TO THE PLATED LEADS AND ARE MEASURED BETWEEN 1.00 AND 2.00 FROM THE LEAD TIP.
4. POSITION OF THE LEAD IS DETERMINED AT THE ROOT OF THE LEAD WHERE IT EXITS THE PACKAGE BODY.
5. SHORTENED/CUT PINS ARE 2,5,8,11,14,17,19,29 AND 30.

MILLIMETERS			
DIM	MIN.	NOM.	MAX.
A	12.20	12.7	13.2
A1	1.00	1.50	2.00
A2	5.50	5.60	5.70
A3	2.00 REF		
A4	1.55 REF		
A5	3.10 REF		
b	0.90	1.00	1.10
b1	1.90	2.00	2.10
b2	0.40	0.50	0.60
b3	1.40	1.50	1.60
c	0.50 REF		
D	54.40	54.50	54.60
D3	39.25 REF		
D4	8.00 REF		
D5	22.00 REF		
D6	24.00 REF		
D7	21.85 REF		
D8	23.85 REF		

MILLIMETERS			
DIM	MIN.	NOM.	MAX.
E	30.90	31.00	31.10
E1	33.50 REF		
E2	26.14 REF		
E3	12.35 REF		
E4	8.00 REF		
E5	35.40	35.90	36.40
e	2.81 REF		
e1	7.62 BSC		
e2	6.60 BSC		
e3	3.30 BSC		
e4	5.35 REF		
e5	6.10 BSC		
e6	8.02 REF		
e7	1.78 BSC		
e8	10.35 REF		
e9	10.25 REF		
e10	3.60 REF		
e11	1.00 REF		
e12	0.89 BSC		
F	3.20	3.30	3.40
F1	1.40	1.50	1.60
L	5.60 REF		

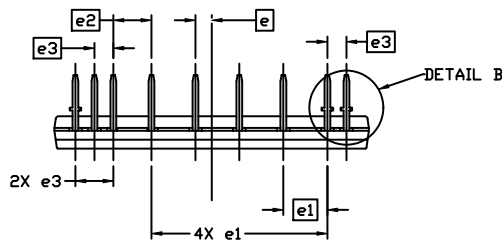
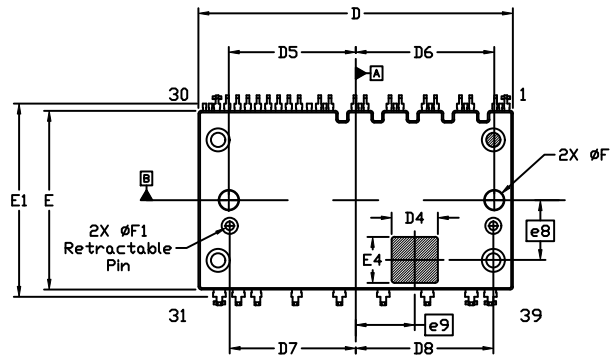
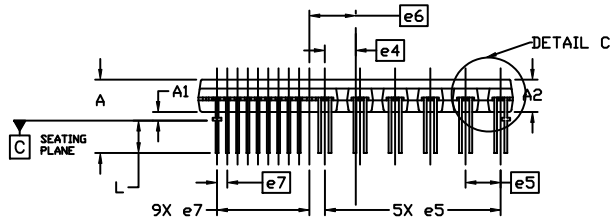

GENERIC MARKING DIAGRAM*

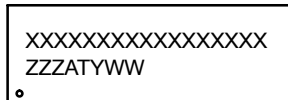

- XXXXX = Specific Device Code
- ZZZ = Assembly Lot Code
- AT = Assembly & Test Location
- Y = Year
- WW = Work Week

*This information is generic. Please refer to device data sheet for actual part marking. Pb-Free indicator, "G" or microdot "▪", may or may not be present. Some products may not follow the Generic Marking.

DOCUMENT NUMBER:	98AON91300G	Electronic versions are uncontrolled except when accessed directly from the Document Repository. Printed versions are uncontrolled except when stamped "CONTROLLED COPY" in red.
DESCRIPTION:	MINI DIP39, 31.0x54.5	PAGE 1 OF 1

ON Semiconductor and ON are trademarks of Semiconductor Components Industries, LLC dba ON Semiconductor or its subsidiaries in the United States and/or other countries. ON Semiconductor reserves the right to make changes without further notice to any products herein. ON Semiconductor makes no warranty, representation or guarantee regarding the suitability of its products for any particular purpose, nor does ON Semiconductor assume any liability arising out of the application or use of any product or circuit, and specifically disclaims any and all liability, including without limitation special, consequential or incidental damages. ON Semiconductor does not convey any license under its patent rights nor the rights of others.

onsemi, **Onsemi**, and other names, marks, and brands are registered and/or common law trademarks of Semiconductor Components Industries, LLC dba "**onsemi**" or its affiliates and/or subsidiaries in the United States and/or other countries. **onsemi** owns the rights to a number of patents, trademarks, copyrights, trade secrets, and other intellectual property. A listing of **onsemi**'s product/patent coverage may be accessed at www.onsemi.com/site/pdf/Patent-Marking.pdf. **onsemi** reserves the right to make changes at any time to any products or information herein, without notice. The information herein is provided "as-is" and **onsemi** makes no warranty, representation or guarantee regarding the accuracy of the information, product features, availability, functionality, or suitability of its products for any particular purpose, nor does **onsemi** assume any liability arising out of the application or use of any product or circuit, and specifically disclaims any and all liability, including without limitation special, consequential or incidental damages. Buyer is responsible for its products and applications using **onsemi** products, including compliance with all laws, regulations and safety requirements or standards, regardless of any support or applications information provided by **onsemi**. "Typical" parameters which may be provided in **onsemi** data sheets and/or specifications can and do vary in different applications and actual performance may vary over time. All operating parameters, including "Typicals" must be validated for each customer application by customer's technical experts. **onsemi** does not convey any license under any of its intellectual property rights nor the rights of others. **onsemi** products are not designed, intended, or authorized for use as a critical component in life support systems or any FDA Class 3 medical devices or medical devices with a same or similar classification in a foreign jurisdiction or any devices intended for implantation in the human body. Should Buyer purchase or use **onsemi** products for any such unintended or unauthorized application, Buyer shall indemnify and hold **onsemi** and its officers, employees, subsidiaries, affiliates, and distributors harmless against all claims, costs, damages, and expenses, and reasonable attorney fees arising out of, directly or indirectly, any claim of personal injury or death associated with such unintended or unauthorized use, even if such claim alleges that **onsemi** was negligent regarding the design or manufacture of the part. **onsemi** is an Equal Opportunity/Affirmative Action Employer. This literature is subject to all applicable copyright laws and is not for resale in any manner.

PUBLICATION ORDERING INFORMATION

LITERATURE FULFILLMENT:

Email Requests to: orderlit@onsemi.com

onsemi Website: www.onsemi.com

TECHNICAL SUPPORT

North American Technical Support:

Voice Mail: 1 800-282-9855 Toll Free USA/Canada

Phone: 011 421 33 790 2910

Europe, Middle East and Africa Technical Support:

Phone: 00421 33 790 2910

For additional information, please contact your local Sales Representative