

产品外观 / Appearance:

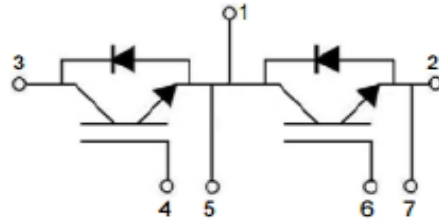

$V_{CES} = 1200V$

$I_{C\ nom} = 50A / I_{CRM} = 100A$

34mm 封装

半桥/ Half Bridge

特性 / Features:

- 采用高速沟槽栅/场终止 IGBT
- 低开关损耗
- 标准封装
- High Speed Trench / Field Stop IGBT
- Low Switching Losses
- Standard Housing

应用 / Applications

- 大功率变流器
- 电机传动
- UPS 系统
- High Power Converters
- Motor Drives
- UPS Systems

IGBT, 逆变器 / IGBT, Inverter

最大额定值 / Maximum Rated Values

集电极-发射极电压 Collector-emitter voltage	$T_j = 25^\circ\text{C}$	$V_{CES}$	1200	V
连续集电极直流电流 Continuous DC collector current	$T_C = 80^\circ\text{C}, T_{j\max} = 150^\circ\text{C}$	$I_{C\text{nom}}$	50	A
集电极重复峰值电流 Repetitive peak collector current	$t_p = 1\text{ms}$	$I_{CRM}$	100	A
总功率损耗 Total power dissipation	$T_C = 25^\circ\text{C}, T_{j\max} = 150^\circ\text{C}$	$P_D$	216	W
栅极-发射极峰值电压 Gate-emitter peak voltage		$V_{GES}$	+/-20	V

特征值 / Characteristic Values

			min.	typ.	max.		
集电极-发射极饱和电压 Collector-emitter saturation voltage	$I_C = 50\text{A}, V_{GE} = 15\text{V}$ $I_C = 50\text{A}, V_{GE} = 15\text{V}$	$T_j = 25^\circ\text{C}$ $T_j = 125^\circ\text{C}$	$V_{CE\text{sat}}$	2.0 2.2	2.3	V V	
栅极阈值电压 Gate threshold voltage	$I_C = 1\text{mA}, V_{CE} = V_{GE}, T_j = 25^\circ\text{C}$		$V_{GE\text{th}}$	5.3	6.0	6.6 V	
栅极电荷 Gate charge	$V_{GE} = -15\text{V}...+15\text{V}$		$Q_G$	320		nC	
内部栅极电阻 Internal gate resistor	$T_j = 25^\circ\text{C}$		$R_{G\text{int}}$	4.0		$\Omega$	
输入电容 Input capacitance	$f = 1\text{MHz}, T_j = 25^\circ\text{C}, V_{CE} = 25\text{V}, V_{GE} = 0\text{V}$		$C_{ies}$	4.83		nF	
反向传输电容 Reverse transfer capacitance	$f = 1\text{MHz}, T_j = 25^\circ\text{C}, V_{CE} = 25\text{V}, V_{GE} = 0\text{V}$		$C_{res}$	0.09		nF	
集电极-发射极截止电流 Collector-emitter cut-off current	$V_{GE} = 0\text{V}, V_{CE} = 1200\text{V}, T_j = 25^\circ\text{C}$		$I_{CES}$		1.0	mA	
栅极-发射极漏电流 Gate-emitter leakage current	$V_{GE} = 20\text{V}, V_{CE} = 0\text{V}, T_j = 25^\circ\text{C}$		$I_{GES}$		200	nA	
开通延迟时间 Turn-on delay time	$V_{CE} = 600\text{V}, I_C = 50\text{A}$ $V_{GE} = \pm 15\text{V},$ $R_{Gon} = 10\Omega,$ $R_{Goff} = 10\Omega,$ Inductive Load	$T_j = 25^\circ\text{C}$ $T_j = 125^\circ\text{C}$	$t_{don}$	38 37		ns ns	
上升时间 Rise Time		$T_j = 25^\circ\text{C}$ $T_j = 125^\circ\text{C}$	$t_r$	60 60		ns ns	
关断延迟时间 Turn-Off Delay Time		$T_j = 25^\circ\text{C}$ $T_j = 125^\circ\text{C}$	$t_{doff}$	150 160		ns ns	
下降时间 Fall Time		$T_j = 25^\circ\text{C}$ $T_j = 125^\circ\text{C}$	$t_f$	140 170		ns ns	
开通能量损耗 Turn-on energy loss		$T_j = 25^\circ\text{C}$ $T_j = 125^\circ\text{C}$	$E_{on}$	4.5 6.0		mJ mJ	
关断损耗能量 Turn-off energy loss		$T_j = 25^\circ\text{C}$ $T_j = 125^\circ\text{C}$	$E_{off}$	1.0 3.5		mJ mJ	
结-外壳热阻 Thermal resistance, junction to case		每个 IGBT / per IGBT		$R_{thJC}$		0.579	K/W
在开关状态下温度 Temperature under switching conditions				$T_{j\text{op}}$	-40	125	$^\circ\text{C}$

二极管, 逆变器 / Diode, Inverter

最大额定值 / Maximum Rated Values

反向重复峰值电压 Repetitive peak reverse voltage	$T_j = 25^\circ\text{C}$	$V_{RRM}$	1200	V
连续正向直流电流 Continuous DC forward current		$I_F$	50	A
正向重复峰值电流 Repetitive peak forward current	$t_p = 1\text{ms}$	$I_{FRM}$	100	A

特征值 / Characteristic Values

				min.	typ.	max.	
正向电压 Forward voltage	$I_F = 50\text{A}, V_{GE} = 0\text{V}$	$T_j = 25^\circ\text{C}$	$T_j = 125^\circ\text{C}$	$V_F$	2.60 2.10	2.90	V V
反向恢复峰值电流 Peak reverse recovery current	$I_F = 50\text{A}, V_R = 600\text{V}$ $V_{GE} = -15\text{V}$	$T_j = 25^\circ\text{C}$	$T_j = 125^\circ\text{C}$	$I_{RM}$	25 36		A A
恢复电荷 Recovered charge		$T_j = 25^\circ\text{C}$	$T_j = 125^\circ\text{C}$	$Q_r$	2.0 4.5		$\mu\text{C}$
反向恢复损耗 Reverse recovery energy		$T_j = 25^\circ\text{C}$	$T_j = 125^\circ\text{C}$	$E_{rec}$	0.7 1.4		mJ
结-外壳热阻 Thermal resistance, junction to case	每个二极管 / per diode			$R_{thJC}$		0.964	K/W
在开关状态下温度 Temperature under switching conditions				$T_{jop}$	-40	125	$^\circ\text{C}$

模块 / Module

绝缘测试电压 Isolation test voltage	RMS, f = 50Hz, t = 1 min.	$V_{ISOL}$	2.5	kV
模块基板材料 Material of module baseplate			Cu	
内部绝缘 Internal isolation	基本绝缘 (class 1, IEC 61140) Basic insulation (class1, IEC 61140)		$Al_2O_3$	
爬电距离 Creepage distance	端子至散热器 / terminal to heatsink 端子至端子 / terminal to terminal		17.0 20.0	mm
电气间隙 Clearance	端子至散热器 / terminal to heatsink 端子至端子 / terminal to terminal		17.0 9.5	mm
相对电痕指数 Comparative tracking index		CTI	>200	

		min.    typ.    max.			
外壳-散热器热阻 Thermal resistance, case to heatsink	每个模块 / per module $\lambda_{Paste} = 1W/(m \cdot K) / \lambda_{grease} = 1W/(m \cdot K)$	$R_{thCH}$		0.05	K/W
杂散电感, 模块 Stray inductance module		$L_{SCE}$		30	nH
储存温度 Storage temperature		$T_{stg}$	-40		125 °C
模块安装的安装扭距 Mounting torque for module mounting	螺丝M6 Screw M6	M	3.0		5.0 Nm
端子联接扭距 Terminal connection torque	螺丝M5 Screw M5	M	2.5		5.0 Nm
重量 Weight				160	g

输出特性 IGBT, 逆变器 (典型)

Output characteristic IGBT, Inverter (typical)

$I_C = f(V_{CE})$

$V_{GE} = 15\text{ V}$

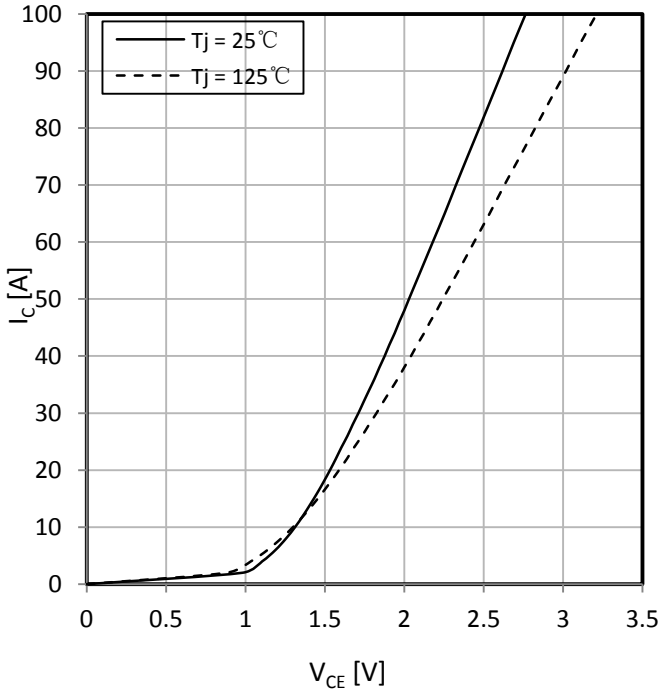

输出特性 IGBT, 逆变器 (典型)

Output characteristic IGBT, Inverter (typical)

$I_C = f(V_{CE})$

$T_j = 125\text{ °C}$

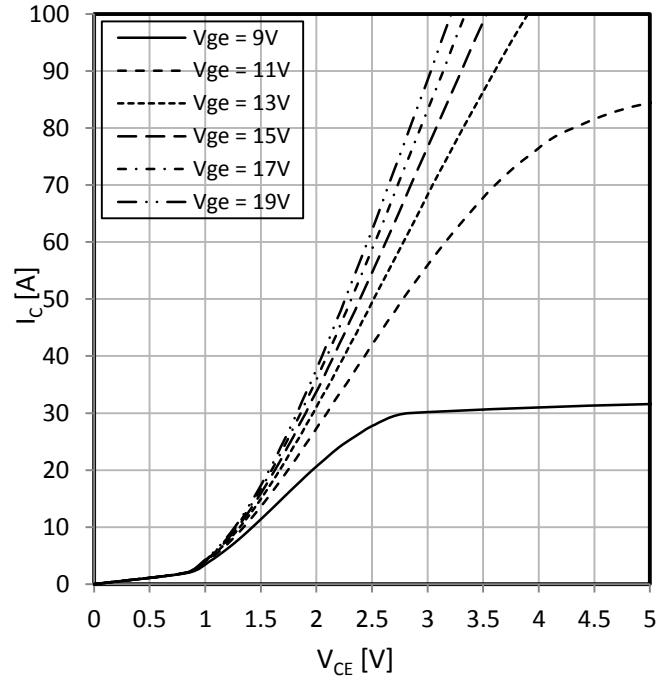

传输特性 IGBT, 逆变器 (典型)

Transfer characteristic IGBT, Inverter (typical)

$I_C = f(V_{GE})$

$V_{CE} = 20\text{ V}$

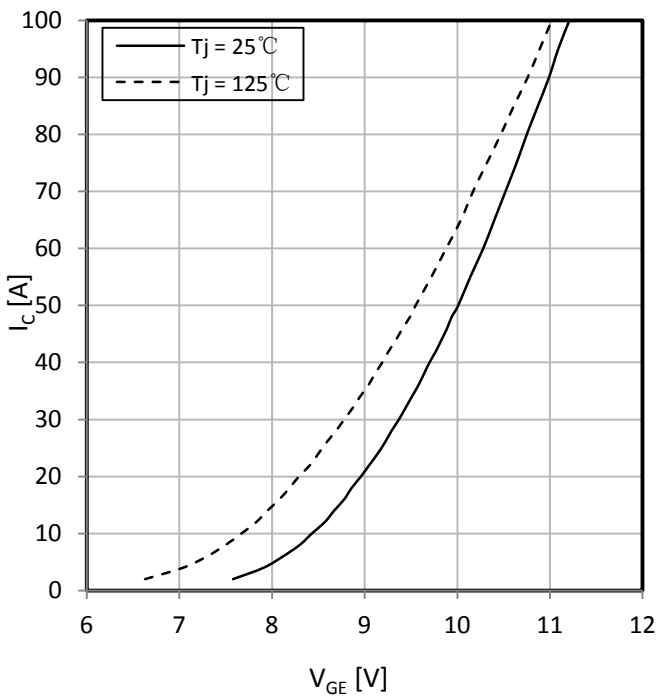

开关损耗 IGBT, 逆变器 (典型)

Switching losses IGBT, Inverter (typical)

$E_{on} = f(I_C), E_{off} = f(I_C)$

$V_{GE} = \pm 15\text{ V}, R_{Gon} = 10\ \Omega, R_{Goff} = 10\ \Omega, V_{CE} = 600\text{ V}$

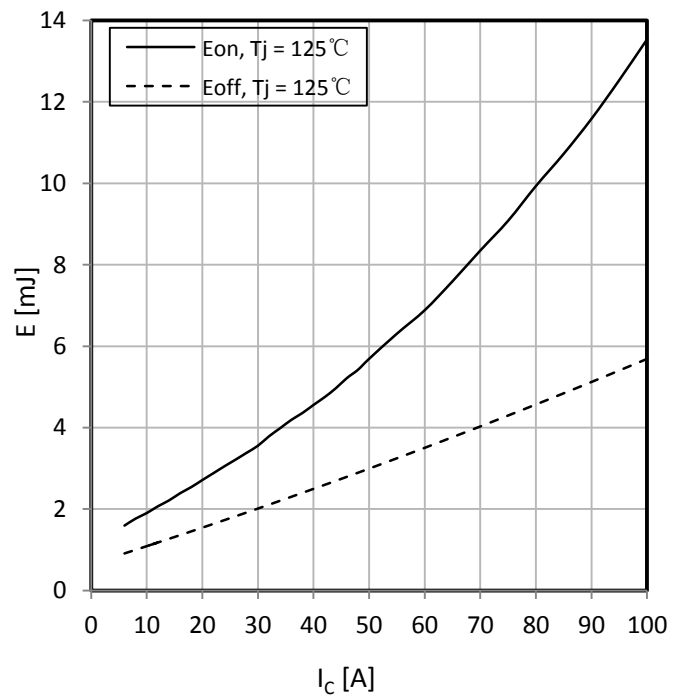

开关损耗 IGBT, 逆变器 (典型)

Switching losses IGBT, Inverter (typical)

$E_{on} = f(R_G), E_{off} = f(R_G),$

$V_{GE} = \pm 15\text{ V}, I_C = 50\text{ A}, V_{CE} = 600\text{ V}$

瞬态热阻抗 IGBT, 逆变器 (典型)

Transient thermal impedance IGBT, Inverter (typical)

$Z_{thjc} = f(t)$

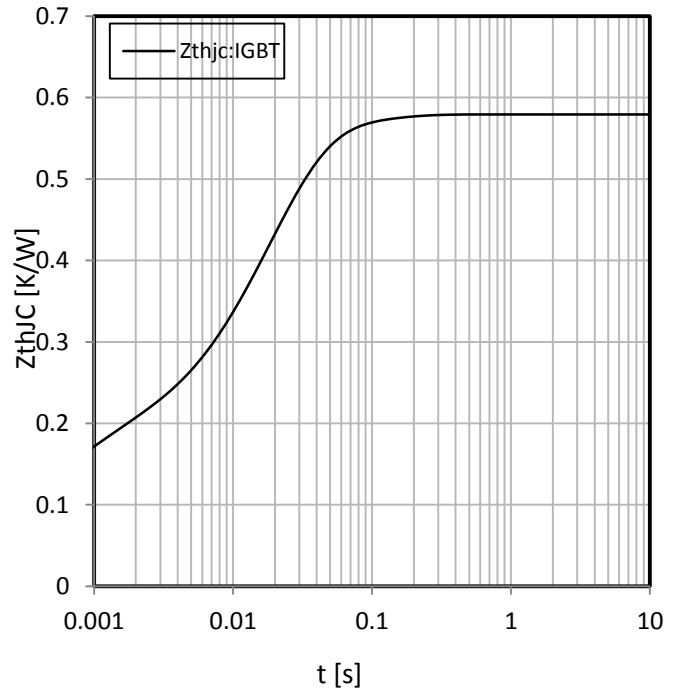
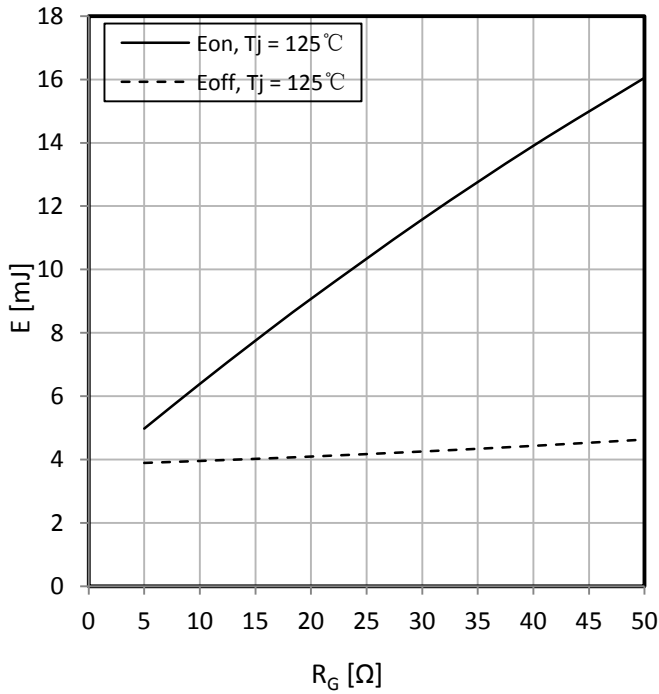

反偏安全工作区 IGBT, 逆变器 (RBSOA)

Reverse bias operating area IGBT, Inverter (RBSOA)

$I_C = f(V_{CE})$

$V_{GE} = \pm 15\text{ V}, R_{Goff} = 10\ \Omega, T_j = 125^\circ\text{C}$

正向偏压特性 二极管, 逆变器 (典型)

Forward characteristic of Diode, Inverter (typical)

$I_F = f(V_F)$

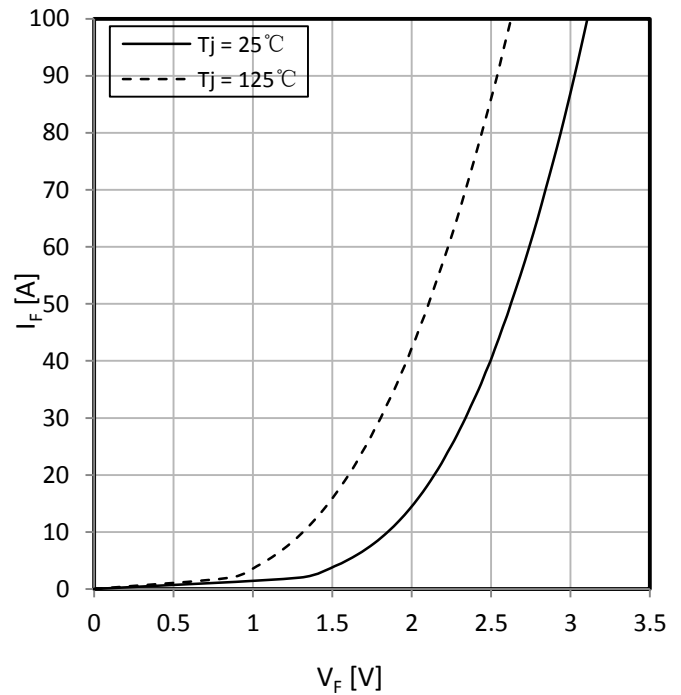
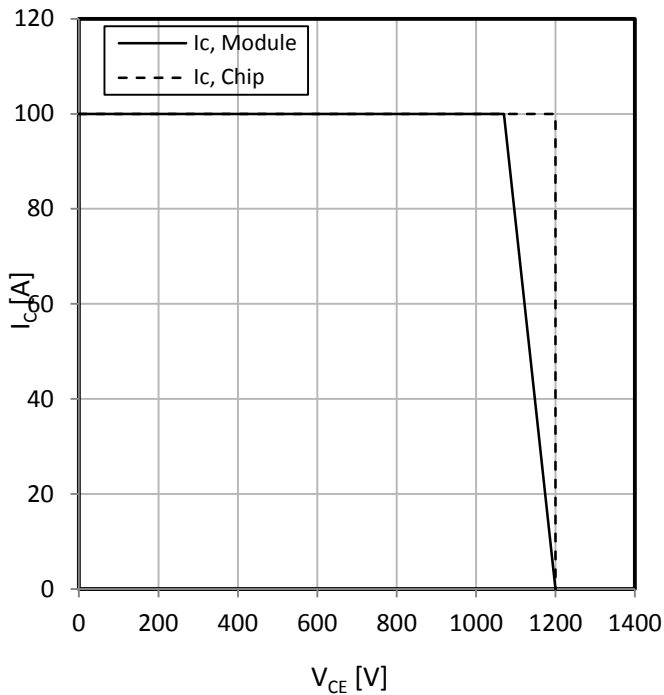

开关损耗 二极管, 逆变器 (典型)  
Switching losses Diode, Inverter (typical)  
 $E_{rec} = f(I_F)$   
 $R_{Gon} = 10 \Omega, V_{CE} = 600 V$

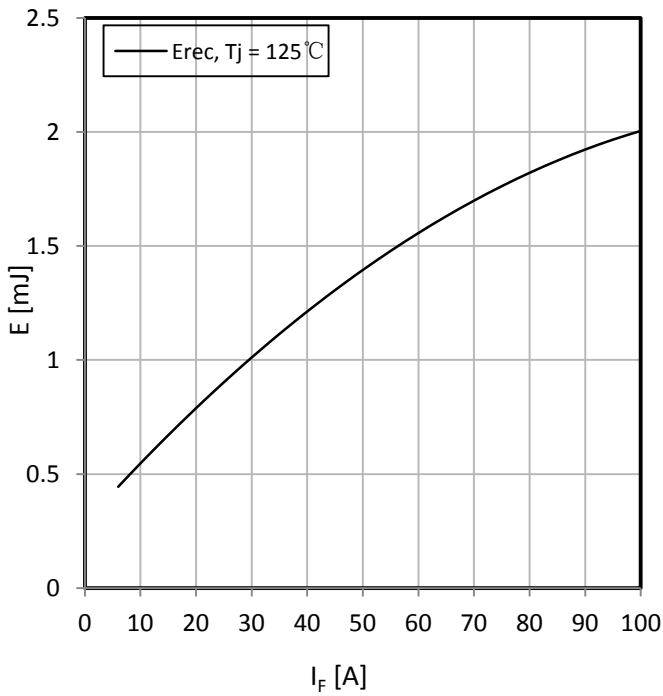

开关损耗 二极管, 逆变器 (典型)  
Switching losses Diode, Inverter (typical)  
 $E_{rec} = f(I_F), I_F = 50 A, V_{CE} = 600 V$

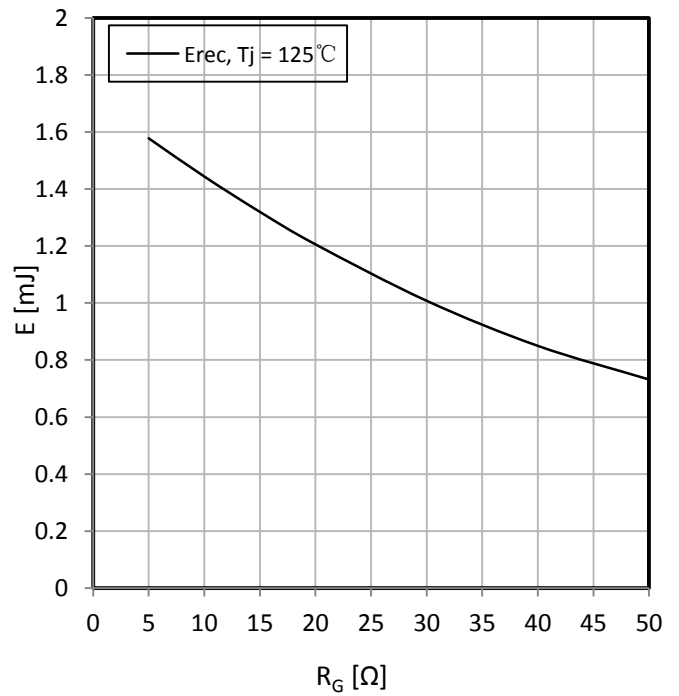

瞬态热阻抗 二极管, 逆变器 (典型)  
Transient thermal impedance Diode, Inverter (typical)  
 $Z_{thjC} = f(t)$

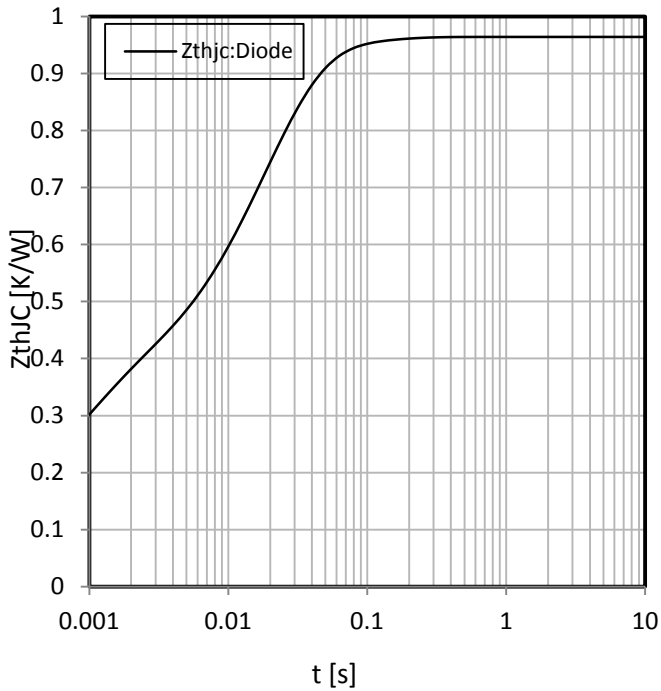

接线图 / Circuit Diagram

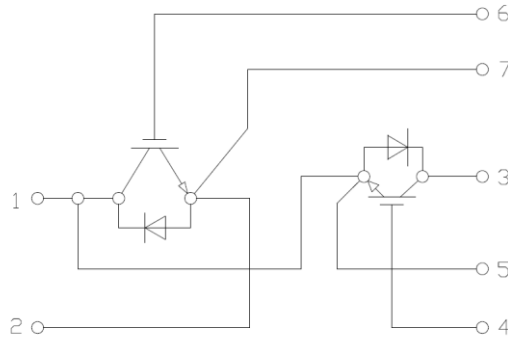

封装尺寸 / Package Outlines

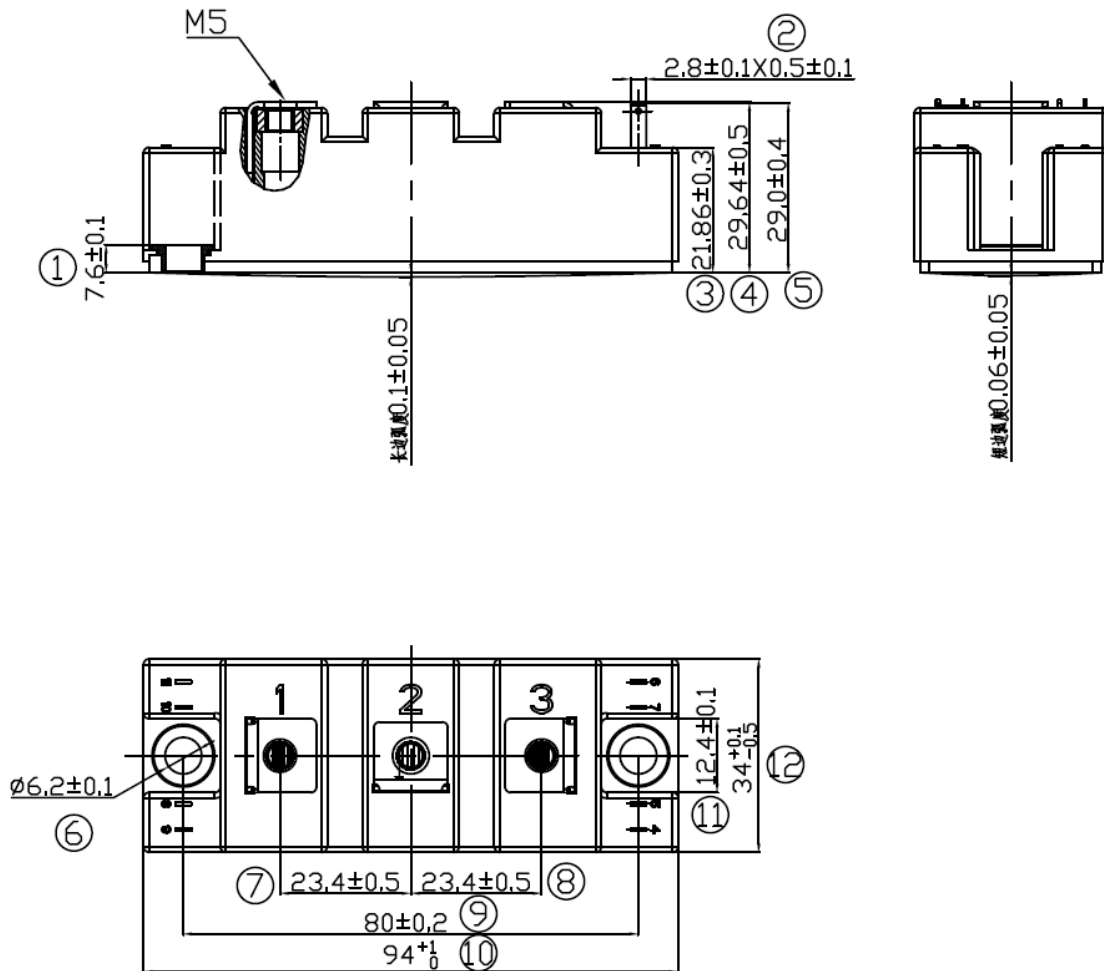



## 警告：

1. 在性能上超过设备的最高额定值可能会对设备造成损坏，甚至永久故障，这可能会影响机器的可靠性。建议在设备最高额定值的80%以下使用。
2. 安装散热器时，请注意散热片的扭转力矩和平滑度。
3. IGBT 是一种对静电敏感的器件，使用时必须保护其免受静电的破坏。
4. 本刊物由华润微电子制作，如有定期更改，恕不另行通知。

## Warnings:

1. Exceeding the maximum ratings of the device in performance may cause damage to the device, even the permanent failure, which may affect the dependability of the machine. It is suggested to be used under 80 percent of the maximum ratings of the device.
2. When installing the heat sink, please pay attention to the torsional moment and the smoothness of the heat sink.
3. IGBTs is the device which is sensitive to the static electricity, it is necessary to protect the device from being damaged by the static electricity when using it.
4. This publication is made by CR Microelectronics and subject to regular change without notice.