



ATPS19 Series Anti-Vandal Short-Body Sealed Pushbutton Switch

NEW

Pushbutton A

Features/Benefits

- **Momentary**
- **IP67 sealed & IK10 (Stainless steel bushing)**
- **Rated at 2A / 36 Vdc**
- **1,000,000 mechanical lifecycles**
- **Various colors of LED illuminate indicator**
- **Choices of actuator with ring or power logo**
- **RoHS compliant**

Typical Applications

- **Alarm, safety & security systems**
- **Intercom "push-to-talk" devices**
- **Automatic food & drink vending machines**
- **Parking lot ticket machines & ticket paying stations**
- **Industrial instruments**



Specifications

FUNCTION: SPST
CONTACT ARRANGEMENT: N.O.
MOUNTING TYPE: Threaded front panel mount
TORQUE FOR THREADED BODY: 11.5 kgf/cm

Mechanical

MECHANICAL LIFE: 1,000,000 cycles
TOTAL TRAVEL: 1.8 ± 0.2 mm
OPERATING FORCE: 4.5 ± 1.5N

Electrical

CONTACT RATING: 2A / 36Vdc
ELECTRICAL LIFE: Make-and-break cycles at full load
200,000
DIELECTRIC STRENGTH: 2,000 V RMS @ sea level
INSULATION RESISTANCE: 1,000 MΩ min. @ 500 VDC
INITIAL CONTACT RESISTANCE : 50 mΩ max @1A 12VDC

Materials

BUSHING: Stainless steel
BASE: PA66, white (UL 94-V0)
ACTUATOR: PC, translucent (UL 94-V2), std steel
INTERNAL ASSEMBLY: PC, transparent (UL 94V2)
SPRING: Steel
SEALING / O-ring: Silicone (Translucent) / Silicone
TERMINALS / CONTACT: Brass, gold flash plated / Brass, silver alloy
HEX NUT: Brass (Nickel plated)

Operating Environment

OPERATING TEMPERATURE: -20°C to +70°C
SEALING / PROTECTION: IP67

NOTE: Specifications and materials listed above are for switches with standard options. For information on specific and custom switches, please contact Customer Service.

Build-A-Switch

To order, simply select desired option from each category and place in the appropriate box.

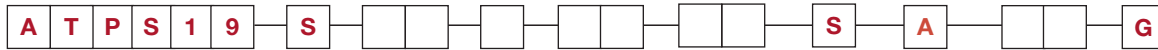

Designation _____

ATPS19 Series

Actuator Style
S Standard

Actuator Indicator
L0 Without LED
L1 Ring
L5 Ring & Power logo

LED Illumination

Color	Dual Color
0 Without LED	A Red & Green
2 White	B Red & Blue
3 Red	
5 Yellow	
6 Green	
7 Blue	

LED Voltage DC
00 0V without resistor
03 3V (47Ω with red/yellow LED)
06 6V (180Ω)
12 12V (470Ω)
24 24V (1000Ω)

Bushing type

M0 Stainless (Natural), Round
M2 Stainless (Natural), D shape
M4 Stainless (Natural), Double D

Terminal Plating
G Gold flash

Termination
04 Solder lug
W1 Wire lead 500mm

Mechanical Function
A Momentary

Contact Arrangement
S SPST



22 Oct 20

NEW

ATPS19 Series Anti-Vandal Short-Body Sealed Pushbutton Switch



A
Pushbutton

STANDARD VIEW

STANDARD

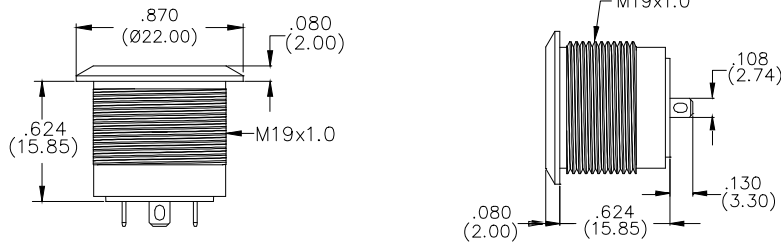

ACTUATOR INDICATOR

L0 WITHOUT LED

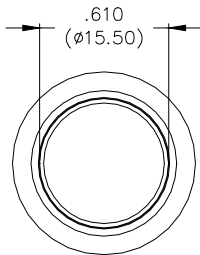

L1 RING

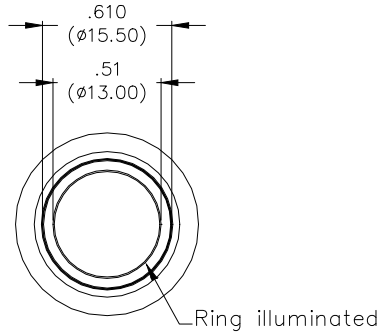

L5 RING & POWER

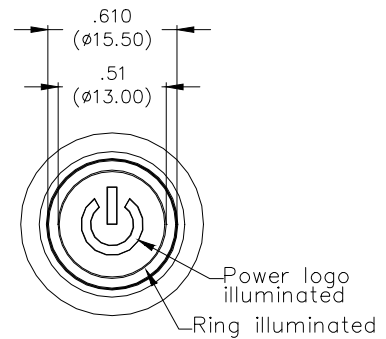

CIRCUIT

MOMENTARY

SINGLE COLOR LED

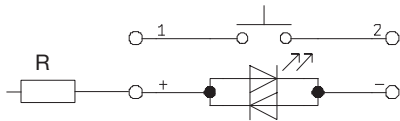

DUAL COLOR LED

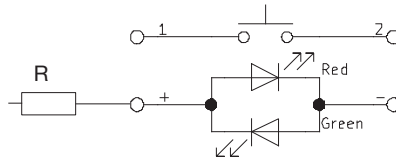

R: Resistor value is according to the LED voltage applied.

Resistor value (Apply LED Voltage)
LED input 3 VDC, 47 ohms (Red/Yellow LED type only)
LED input 6 VDC, 180 ohms
LED input 12 VDC, 470 ohms
LED input 24 VDC, 1000 ohms

Ohms value of resistance tolerance: ±5%



ATPS19 Series

Anti-Vandal Short-Body Sealed Pushbutton Switch

NEW

A
Pushbutton

TERMINATION

04 SOLDER LUG

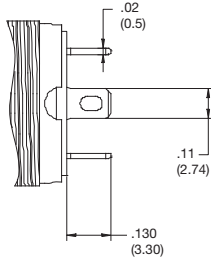

W1 WIRE LEAD 500MM* (Multi-wire lead AWG20, Section 0.6 mm², UL approved)

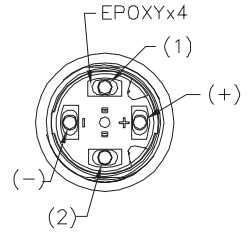
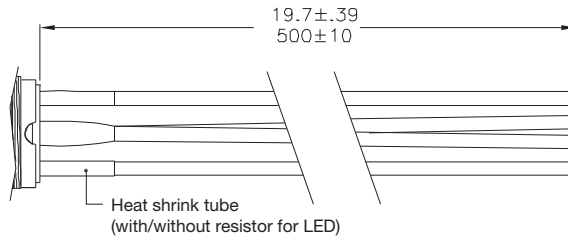

Non-LED

Description	Wire color
Terminal 1	Black
Terminal 2	Black

With LED

Description	Wire color
Terminal 1	Black
Terminal 2	Black
LED+	Red
LED-	Green

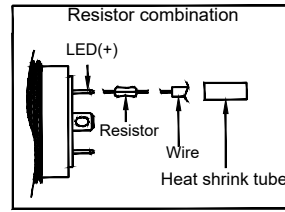

* Special length, please consult your sales representative for details.

PANEL CUTOUT

M0

ROUND

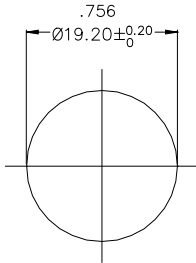

M2

D SHAPE

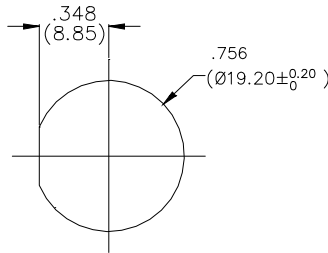

M4

DOUBLE D

Thickness: 6.0mm (Max.)

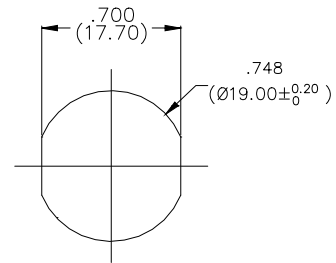

HARDWARE

HEX NUT

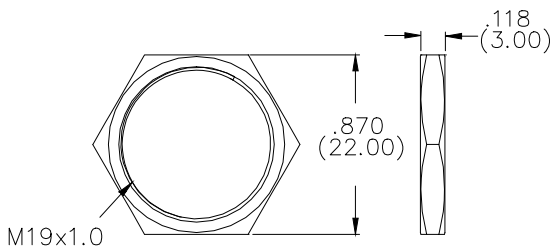

O RING

