

6MHz, Rail-to-Rail I/O CMOS Op Amps

Feature

- **Stable 6MHz GBWP with Low I_Q of Only 150 μ A Typical per Amplifier**
- **Offset Voltage: +/-1mV Maximum**
- **High Slew Rate: 3.7V/ μ s**
- **Input Bias Current: 1pA Typical**
- **CMRR/PSRR:100dB/100dB**
- **Settling time to 0.1% with 2V Step: 0.46us**
- **Beyond the Rails Input Common-Mode Range**
- **Output Swing to within 10mV Typical of each Rail**
- **No Phase Reversal for Overdriven Inputs**
- **Supply Voltage Range: 2.5V to 5.5V**
- **-40 $^{\circ}$ C to 125 $^{\circ}$ C Operation Range**
- **Green, Popular Type Package**

Applications

- **Active Filters, ASIC Input or Output Amplifier**
- **Sensor Interface**
- **Smoke/Gas/Environment Sensors**
- **Portable Instruments and Mobile Device**
- **Audio Output**
- **PCMCIA Cards**
- **Battery or Solar Power Systems**
- **Medical Equipment**
- **Piezo Electrical Transducer Amplifier**

General Description

The HT1188 are CMOS op-amps with low offset, stable high frequency response, low power, low supply voltage, and rail-to-rail inputs and outputs.

HT1188 have a high gain-bandwidth product of 6MHz, 3.7V/ μ s slew rate while consuming only 330 μ A of supply current per amplifier. The maximum input offset voltage is 200uV for HT1188. Beyond the rail input and rail-to-rail output characteristics allow the full power-supply voltage to be used for signal range. The operating range is from 2.5V to 5.5V.

This combination of features makes the HT1188 superior among rail-to-rail input/output CMOS op amps in its power class. It is specified over the extended industrial temperature rang -40 $^{\circ}$ C to +125 $^{\circ}$ C.

The HT1188 can be used as cost-effective plug-in replacements for many commercially available op amps to reduce power and improve input/output range and performance.

Absolute Maximum Ratings

(If out of these ratings, the filter may be fail or damaged)

Table 1

Symbol	parameter	rating	units
VDD	Power supply	6	V
T _A	Operating ambient Temperature Range	-40~+125	°C
T _{STG}	Storage Temperature	-65~+150	°C

Recommended Operating Conditions

Table 2

Symbol	parameter	rating	units
VDD	Power supply	2.5~5.5	V
T _A	Operating ambient Temperature Range	-40~+125	°C

Electrical Characteristics

Specifications are at $T_A=+27^{\circ}\text{C}$, $V_{DD}=5\text{V}$, $V_{CM}=V_{OUT}=V_{DD}/2$, $R_L=10\text{Kohm}$, $C_L=100\text{pF}$

Symbol	Parameter	Spec			Units
		Min	Typ	Max	
VCC	Operating Supply Voltage	2.5	5	5.5	V
V _{OS}	Input Offset Voltage	-1	+/-0.5	+1	mV
V _{OS_TC}	Input Offset voltage Temp Drift		4		$\mu\text{V}/^{\circ}\text{C}$
en	Input Voltage Noise Density: f=1KHz		25		nV/ $\sqrt{\text{Hz}}$
C _{IN}	Input Capacitance	Differential	1.5		pF
		Common Mode	3.0		
R _{IN}	Input Resistance	>100			G Ω
I _Q	Quiescent Current per Amplifier		150	330	μA
I _{out}	Output Current		50		mA
V _{in_cm}	Common mode Input voltage	0		VDD-0.1	V
V _{OL}	Output Voltage from supply Swing		10		mV
CMRR	Common Mode Rejection Ratio		100		dB
I _{sc}	Output short-circuit current		80		mA
PM	Phase Margin		65		$^{\circ}$
GM	Gain Margin		-10		dB
GBWP	Gain-Bandwidth Product		6		
MHz PSRR	Power supply rejection ratio: 1Hz 1KHz		100 72		dB
t _s	Settling time, 1.5V to 3.5V, Unity Gain: 0.1%		0.46		μs
SR	Slew Rate		3.7		μs
THD+Noise	Total Harmonic Distortion and Noise: f=1KHz		0.0007		%

Typical performance characteristics

At $T_A=+27^{\circ}\text{C}$, $V_{\text{dd}}=5\text{V}$, $V_{\text{CM}}=V_{\text{OUT}}=V_{\text{DD}}/2$, $R_{\text{L}}=10\text{Kohm}$, $C_{\text{L}}=100\text{pF}$

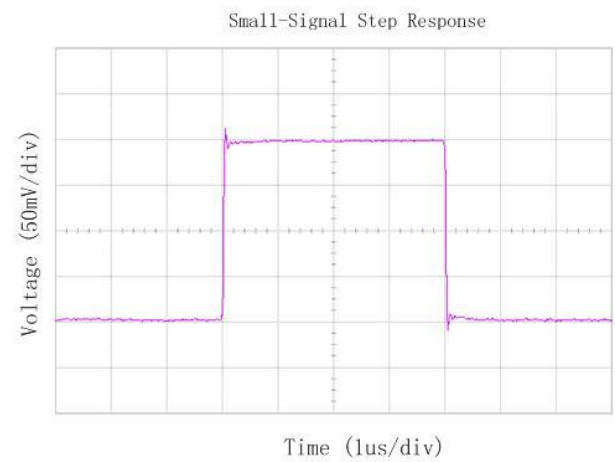
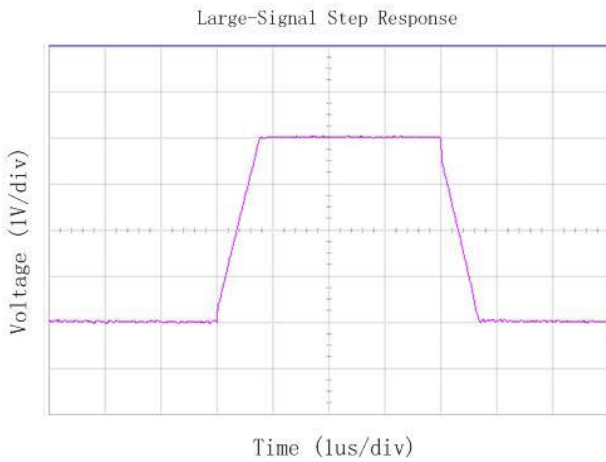
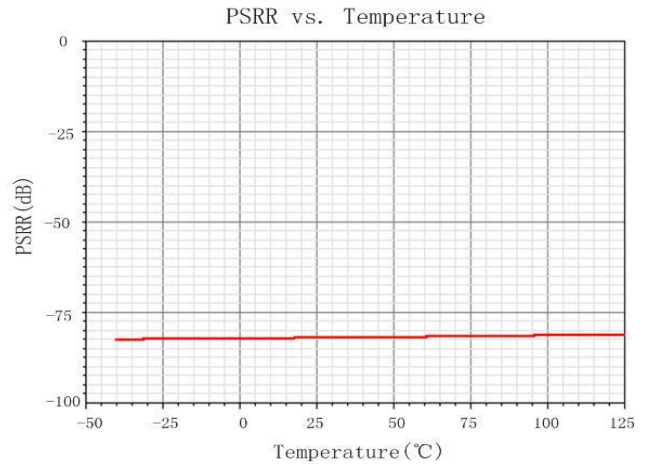
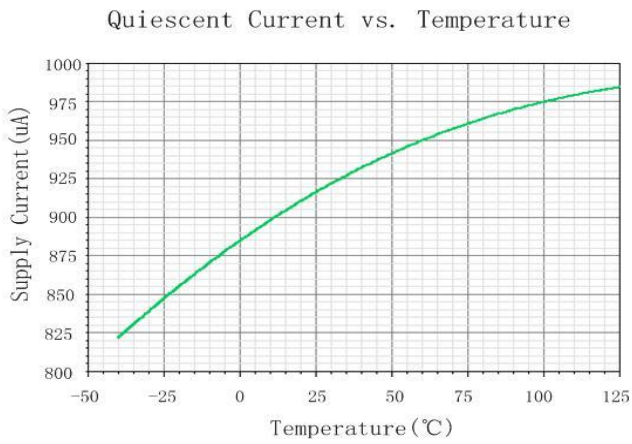
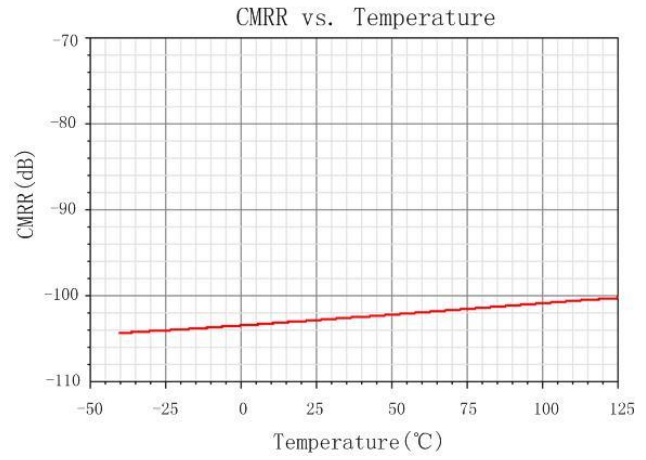
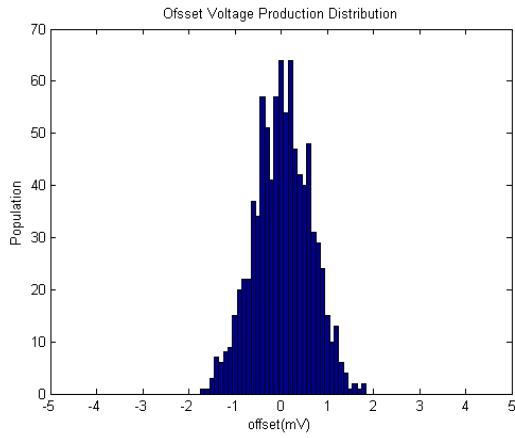

Application Circuits

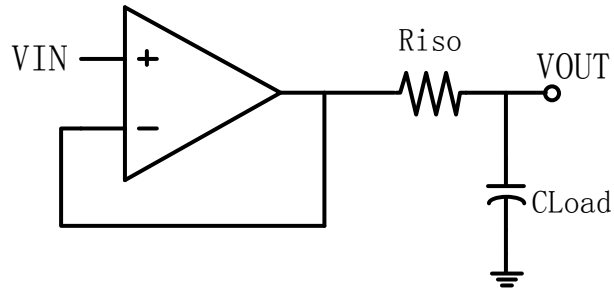

PIN Definition

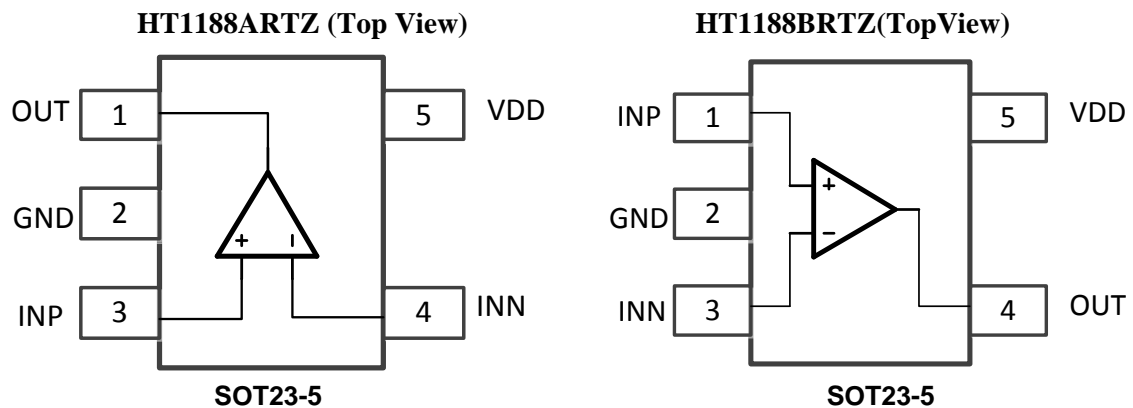

Name	I/O	Analog/Digital	Description
INP	I	A	Non-Inverting Input of Amplifier. Voltage range of this pin can go from 0 to VDD.
GND	GROUND	GROUND	Ground pin. Connect to the most negative supply, ALL GND pads are connected on die.
INN	I	A	Inverting Input of Amplifier. This pin has same voltage range as INP.
OUT	O	A	Amplifier Output. The voltage range extends to within millivolts of each supply rail.
VDD	POWER	POWER	Power supply (5V) ,connect to positive voltage supply

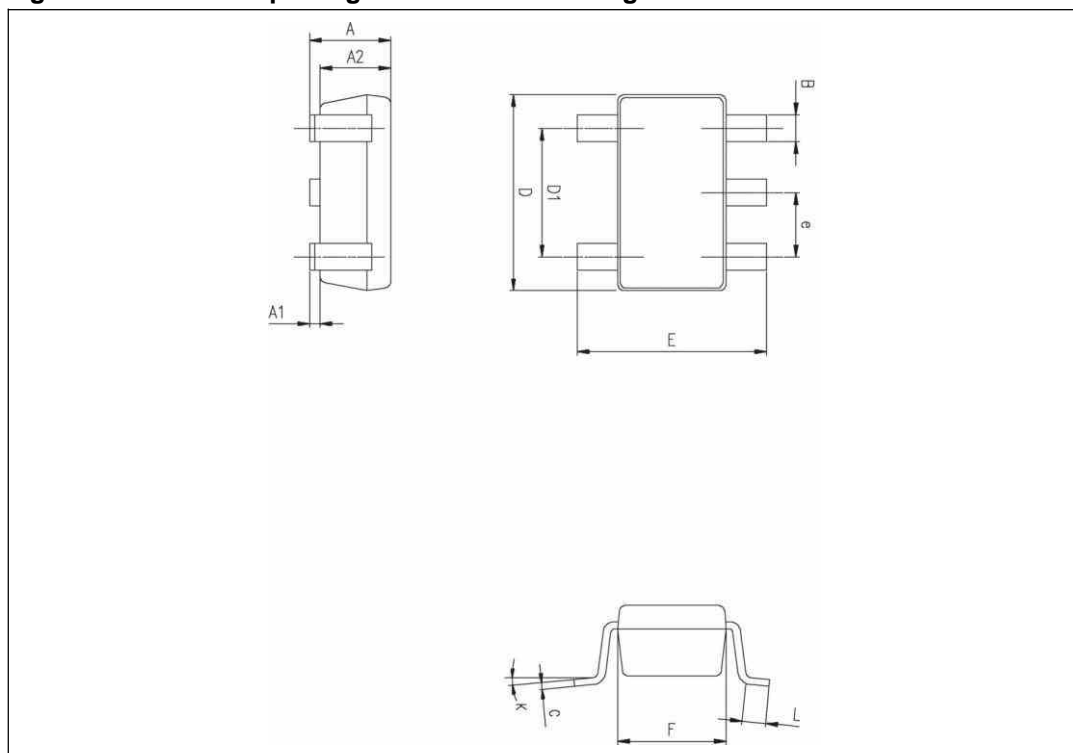
SOT23-5 package
Figure 10. SOT23-5 package mechanical drawing

Table 5. SOT23-5 package mechanical data

Ref.	Dimensions					
	Millimeters			Inches		
	Min.	Typ.	Max.	Min.	Typ.	Max.
A	0.90	1.20	1.45	0.035	0.047	0.057
A1			0.15			0.006
A2	0.90	1.05	1.30	0.035	0.041	0.051
B	0.35	0.40	0.50	0.013	0.015	0.019
C	0.09	0.15	0.20	0.003	0.006	0.008
D	2.80	2.90	3.00	0.110	0.114	0.118
D1		1.90			0.075	
e		0.95			0.037	
E	2.60	2.80	3.00	0.102	0.110	0.118
F	1.50	1.60	1.75	0.059	0.063	0.069
L	0.10	0.35	0.60	0.004	0.013	0.023
K	0 degrees		10 degrees			