

Description

The AU0521M1 is a bi-directional TVS diode, utilizing leading monolithic silicon technology to provide fast response time and low ESD clamping voltage, making this device an ideal solution for protecting voltage sensitive data and power line. The AU0521M1 complies with the IEC 61000-4-2 (ESD) with ± 30 kV air and ± 30 kV contact discharge. It is assembled into an ultra-small 1.0x0.6x0.5mm lead-free 0402 package. The small size and high ESD surge protection make AU0521M1 an ideal choice to protect cell phone, digital cameras, audio players and many other portable applications.

Features

- Ultra small package: 1.0x0.6x0.5mm
- Protects one data or power line
- Ultra low leakage: nA level
- Operating voltage: 5V
- Low clamping voltage
- 2-pin leadless package
- Complies with following standards:
 - IEC 61000-4-2 (ESD) immunity test
Air discharge: ± 30 kV
Contact discharge: ± 30 kV
 - IEC61000-4-5 (Lightning) 8A (8/20 μ s)
- RoHS Compliant

Mechanical Characteristics

- Package: 0402
- Lead Finish: Sn
- Case Material: “Green” Molding Compound.
- Moisture Sensitivity: Level 3 per J-STD-020
- Terminal Connections: See Diagram Below
- Marking Information: See Below

Applications

- Cellular Handsets and Accessories
- Personal Digital Assistants
- Notebooks and Handhelds
- Portable Instrumentation
- Digital Cameras
- Peripherals
- Audio Players
- Keypads, Side Keys, LCD Displays

Ordering Information

Part Number	Packaging	Reel Size
AU0521M1	10000/Tape & Reel	7 inch

Dimensions and Pin Configuration

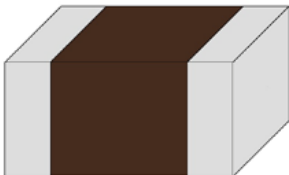

Package Outline

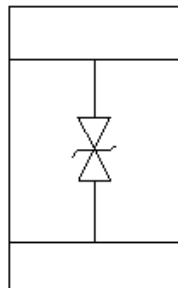

Circuit Schematic

Absolute Maximum Ratings ($T_A=25^{\circ}\text{C}$ unless otherwise specified)

Parameter	Symbol	Value	Unit
Peak Pulse Power (8/20 μs)	Ppk	100	W
Peak Pulse Current (8/20 μs)	I _{PP}	8	A
ESD per IEC 61000-4-2 (Air)	V _{ESD}	± 30	kV
ESD per IEC 61000-4-2 (Contact)		± 30	
Operating Temperature Range	T _J	-55 to +125	$^{\circ}\text{C}$
Storage Temperature Range	T _{stg}	-55 to +150	$^{\circ}\text{C}$

Electrical Characteristics ($T_A=25^{\circ}\text{C}$ unless otherwise specified)

Parameter	Symbol	Min	Typ	Max	Unit	Test Condition
Reverse Working Voltage	V _{RWM}			5	V	
Breakdown Voltage	V _{BR}	5.8		7.5	V	I _T = 1mA
Reverse Leakage Current	I _R			0.2	μA	V _{RWM} = 5V
Clamping Voltage	V _C			8	V	I _{PP} = 1A
Clamping Voltage	V _C			12	V	I _{PP} = 8A
Junction Capacitance	C _J		10		pF	V _R = 0V, f = 1MHz

Typical Performance Characteristics ($T_A=25^\circ\text{C}$ unless otherwise Specified)

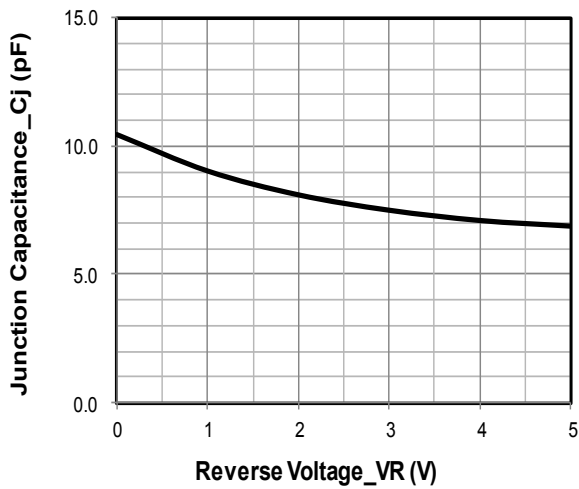

Junction Capacitance vs. Reverse Voltage

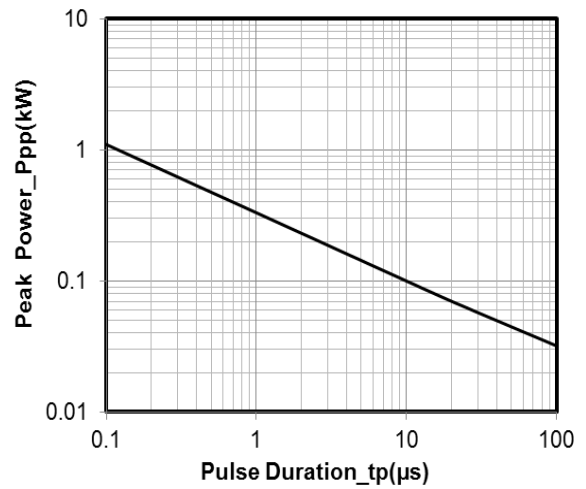

Peak Pulse Power vs. Pulse Time

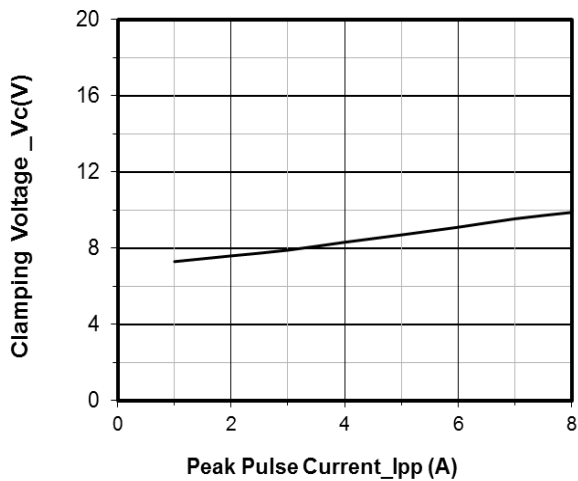

Clamping Voltage vs. Peak Pulse Current ($t_p = 8/20\mu\text{s}$)

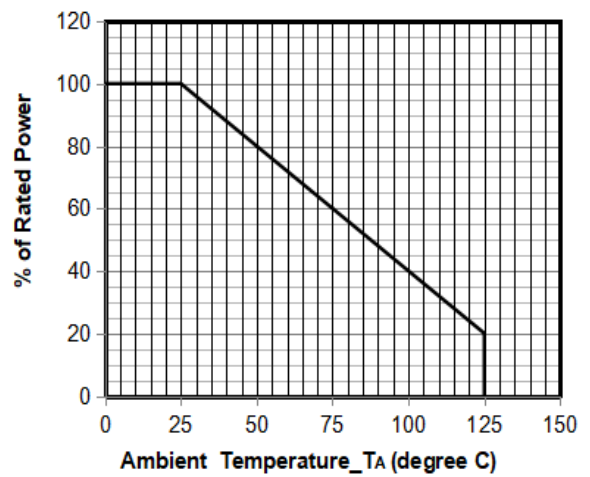

Power Derating Curve

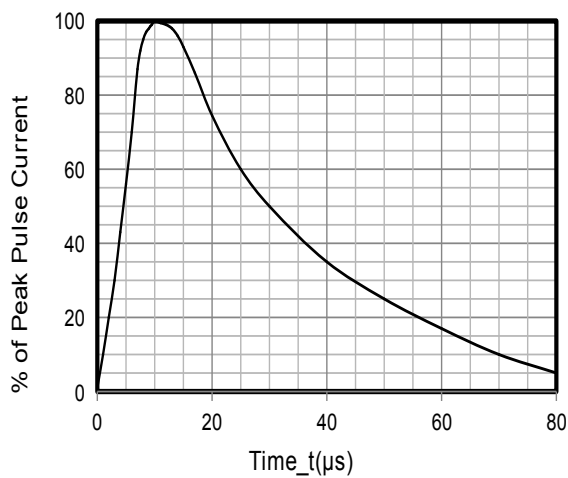

8 X 20μs Pulse Waveform

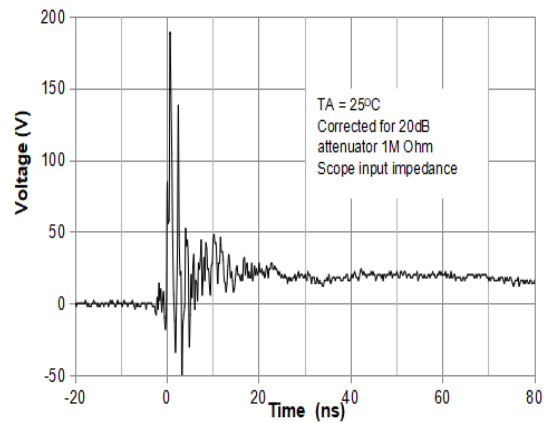

**ESD Clamping Voltage
8 kV Contact per IEC61000-4-2**

Re-flow Solder Profile

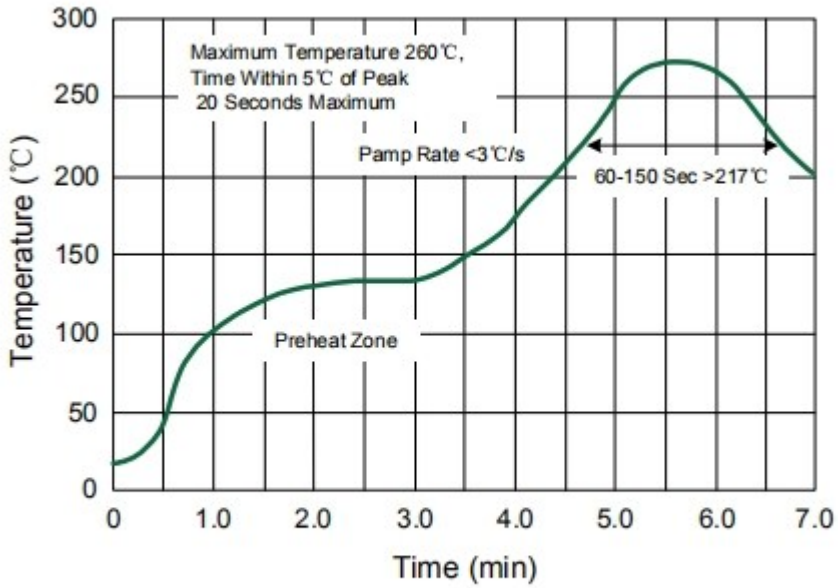

Lead-free Re-flow Solder Profile

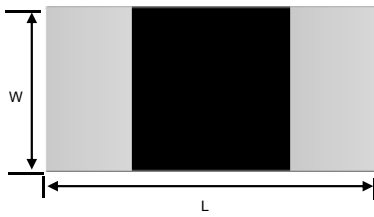
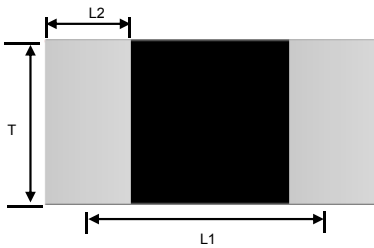
0402 Package Outline Drawing

Top

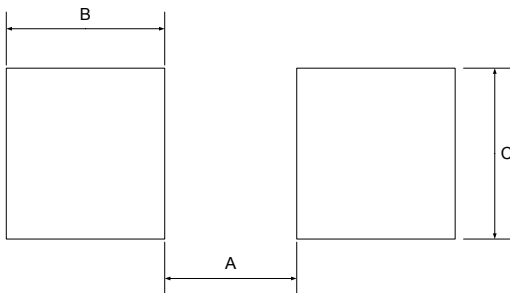
Side View

SYM	DIMENSIONS					
	MILLIMETERS			INCHES		
	MIN	NOM	MAX	MIN	NOM	MAX
W	0.45	0.55	0.65	0.018	0.022	0.026
L	0.95	1.00	1.05	0.038	0.040	0.042
T	0.45	0.55	0.65	0.018	0.022	0.026
L1	0.75 BSC			0.030 BSC		
L2	0.15	0.20	0.25	0.006	0.008	0.010

Suggested Land Pattern

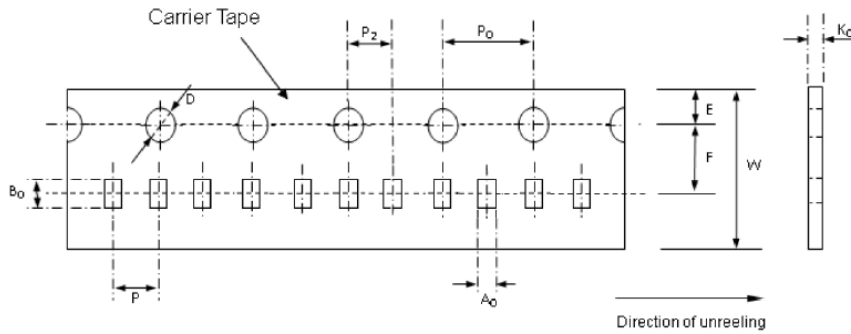
SYM	DIMENSIONS
	MILLIMETERS
A	0.40-0.60
B	0.50-0.70
C	0.60-0.70

0402 Tape and Reel Specification



(Unit: mm)

Symbol	A_0 ± 0.05	B_0 ± 0.05	K_0 ± 0.05	D $+0.10$ -0.05	P ± 0.10	P_2 ± 0.10	P_0 ± 0.10	W ± 0.10	E ± 0.10	F ± 0.05
0402	0.70	1.12	0.60	1.50	2.00	2.00	4.00	8.00	1.75	3.50

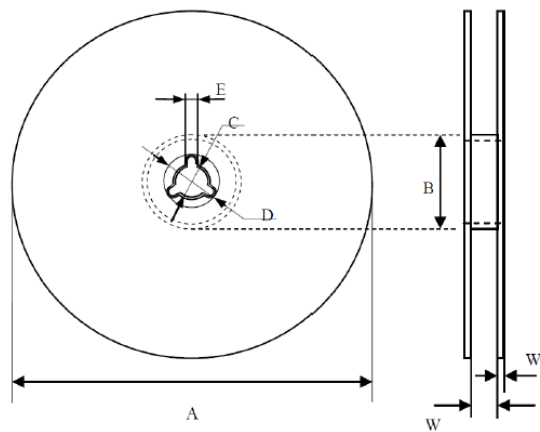

(Unit: mm)

Symbol	A	B	C	D	E	W	W_1
0402	178.0 \pm 1.0	60.0 \pm 0.5	13.0 \pm 0.2	21.0 \pm 0.2	2.0 \pm 0.5	9.0 \pm 0.5	1.5 \pm 0.1

Contact Information

Applied Power Microelectronics Co., Ltd.

Website: <http://www.appliedpowermicro.com>

Email: sales@appliedpowermicro.com

Phone: +86 (0519) 8399 3606