

### Description

The AU4571D3 is an Uni-directional high power TVS diode, utilizing leading monolithic silicon technology to provide fast response time and low ESD clamping voltage, making this device an ideal solution for protecting voltage sensitive data and power line. The AU4571D3 complies with the IEC 61000-4-2 (ESD) with  $\pm 30\text{kV}$  air and  $\pm 30\text{kV}$  contact discharge. It is assembled into an ultra-small lead-free SOD-323 package. The small size and high ESD surge protection make AU4571D3 an ideal choice to protect cell phone, digital cameras, audio players and many other portable applications.

### Features

- Small SOD-323 package
- Protects one data or power line
- Operating Voltage: 4.5V
- High peak pulse current capability
- Ultra low clamping voltage
- Complies with following standards:
  - IEC 61000-4-2 (ESD) immunity test
    - Air discharge:  $\pm 30\text{kV}$
    - Contact discharge:  $\pm 30\text{kV}$
  - IEC61000-4-5 (Lightning) 130A (8/20 $\mu\text{s}$ )
- RoHS Compliant

### Mechanical Characteristics

- Package: SOD-323
- Lead Finish: Matte Tin
- Case Material: “Green” Molding Compound.
- Moisture Sensitivity: Level 3 per J-STD-020
- Terminal Connections: See Diagram Below
- Marking Information: See Below

### Applications

- Mobile Phones and Accessories
- Battery Protection
- Power Supply Protection
- Hand Held Portable Applications
- Peripherals

### Marking Information

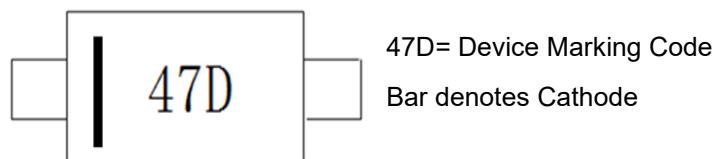

### Dimensions and Pin Configuration

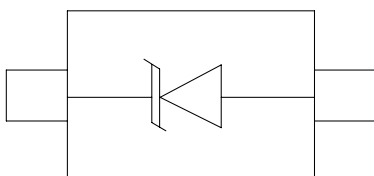

### **SOD-323 (Top View)**

Circuit Diagram

### Ordering Information

Part Number	Marking	Packaging	Reel Size
AU4571D3	47D	3000/Tape & Reel	7 inch

**Absolute Maximum Ratings ( $T_A=25^{\circ}\text{C}$  unless otherwise specified)**

Parameter	Symbol	Value	Unit
Peak Pulse Power (8/20 $\mu\text{s}$ )	Ppk	2200	W
Peak Pulse Current (8/20 $\mu\text{s}$ )	Ipp	130	A
ESD per IEC 61000-4-2 (Air)	VESD	$\pm 30$	kV
ESD per IEC 61000-4-2 (Contact)		$\pm 30$	
Operating Temperature Range	TJ	-55 to +125	$^{\circ}\text{C}$
Storage Temperature Range	Tstg	-55 to +150	$^{\circ}\text{C}$

**Electrical Characteristics ( $T_A=25^{\circ}\text{C}$  unless otherwise specified)**

Parameter	Symbol	Min	Typ	Max	Unit	Test Condition
Reverse Working Voltage	VRWM			4.5	V	
Breakdown Voltage	VBR	4.7			V	IT = 1mA
Reverse Leakage Current	IR			1	$\mu\text{A}$	VRWM = 4.5V
Clamping Voltage	VC			8.5	V	IPP = 20A (8 x 20 $\mu\text{s}$ pulse)
Clamping Voltage	VC			17	V	IPP = 130A (8 x 20 $\mu\text{s}$ pulse)
Junction Capacitance	CJ		500		pF	VR = 0V, f = 1MHz

**Typical Performance Characteristics (T<sub>A</sub>=25°C unless otherwise Specified)**

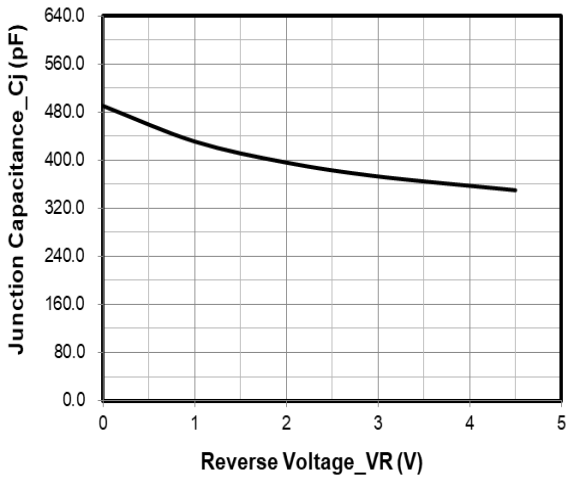

**Junction Capacitance vs. Reverse Voltage**

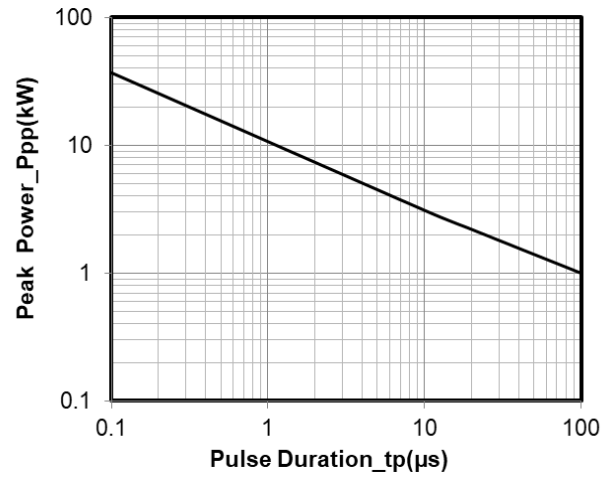

**Peak Pulse Power vs. Pulse Time**

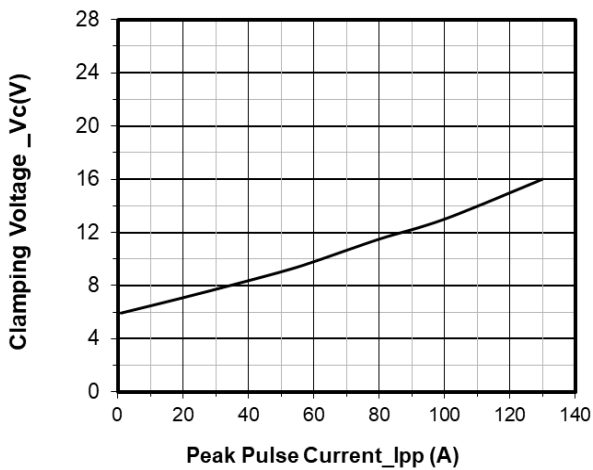

**Clamping Voltage vs. Peak Pulse Current (t<sub>p</sub> = 8/20 μs)**

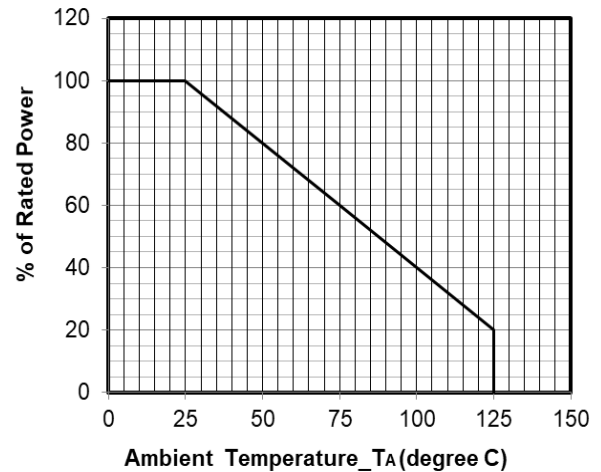

**Power Derating Curve**

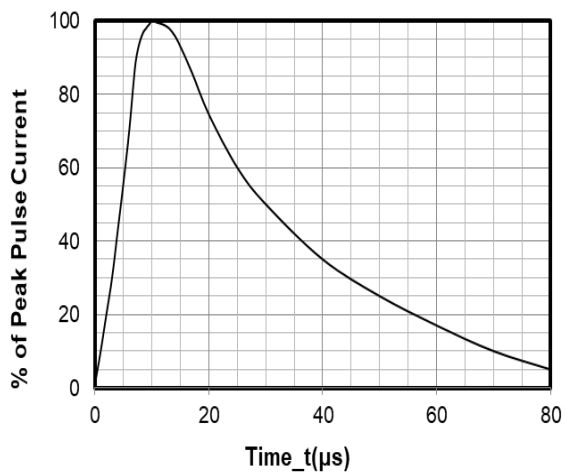

**8 X 20 μs Pulse Waveform**

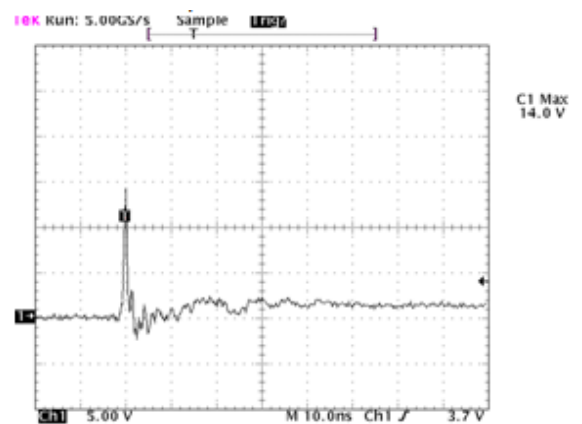

Note: Data is taken with a 10x attenuator

**ESD Clamping Voltage**

**8 kV Contact per IEC61000-4-2**

### SOD-323 Package Outline Drawing

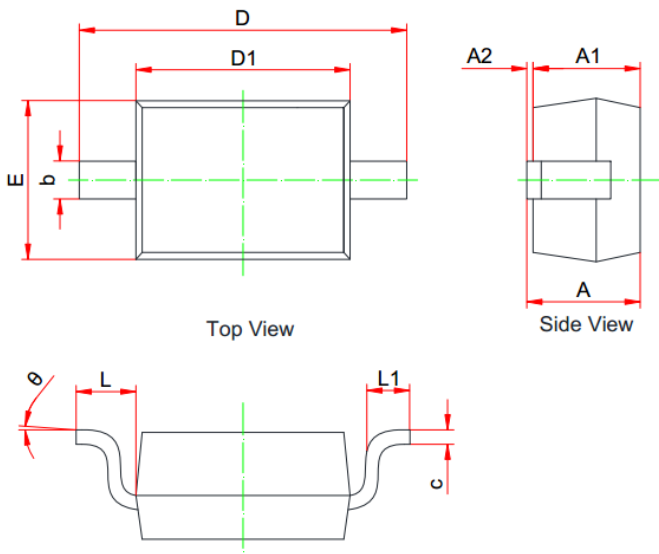

SYM	MILLIMETERS		
	MIN	NOM	MAX
A	0.800	--	1.100
A1	0.800	--	0.900
A2	0.000	--	0.100
b	0.250	--	0.400
c	0.080	--	0.177
D1	1.600	1.700	1.800
D	2.300	--	2.800
E	1.150	--	1.400
L	0.475REF		
L1	0.100	--	0.500
$\theta$	0°	--	8°

### Suggested Land Pattern



**Unit: mm**

### Contact Information

Applied Power Microelectronics Co., Ltd.

Website: <http://www.appliedpowermicro.com>

Email: [sales@appliedpowermicro.com](mailto:sales@appliedpowermicro.com)

Phone: +86 (0519) 8399 3606