

Wide Band Low Noise Amplifier GaAs MMIC

■ GENERAL DESCRIPTION

The NJG1152KA1 is a fully matched wide band low noise amplifier GaAs MMIC for terrestrial application.

To achieve wide dynamic range, the NJG1152KA1 offers high gain mode and low gain mode. Selecting high gain mode for weak signals, the NJG1152KA1 helps improve receiver sensitivity through high gain and low noise figure. Selecting low gain mode for strong signals, it bypasses LNA circuit to offer higher linearity.

An small and ultra-thin package of FLP6-A1 is adopted.

■ PACKAGE OUTLINE

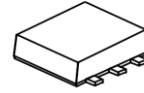

NJG1152KA1

■ APPLICATIONS

Terrestrial application like Digital TV, Set-top box

■ FEATURES

- Operating frequency 40 to 900MHz
- Package size FLP6-A1 (Package size: 1.6x1.6x0.55mm typ.)

[LNA mode, 50Ω: Operating voltage 3.3V]

- Operating current 20mA typ.
- Small signal gain 18.0dB typ.
- Noise figure 1.2dB typ. @f=40 to 150MHz
0.9dB typ. @f=150 to 900MHz

[Bypass mode, 50Ω: Operating voltage 0V]

- Insertion loss 1.0dB typ.
- 2nd order intermodulation distortion 75dB typ.
- 3rd order intermodulation distortion 85dB typ.

■ PIN CONFIGURATION

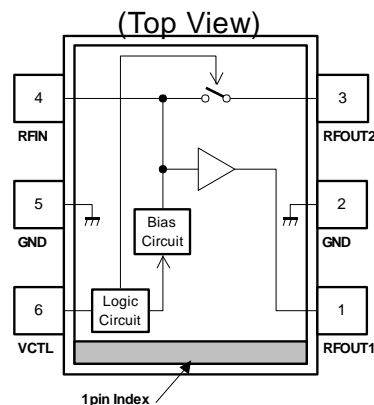

Pin connection

1. RFOUT1
2. GND
3. RFOUT2
4. RFIN
5. GND
6. VCTL

■ TRUTH TABLE

"H" = $V_{CTL(H)}$ "L" = $V_{CTL(L)}$

V_{CTL}	LNA	Bypass	Mode select
H	ON	OFF	LNA mode
L	OFF	ON	Bypass mode

Note: Specifications and description listed in this datasheet are subject to change without notice.

■ ABSOLUTE MAXIMUM RATINGS

$T_a=+25^{\circ}\text{C}$, $Z_s=Z_l=50\Omega$

PARAMETER	SYMBOL	CONDITIONS	RATINGS	UNITS
Drain voltage	V_{DD}		5.0	V
Control voltage	V_{CTL}		5.0	V
Input power	P_{IN}	$V_{DD}=3.3\text{V}$	+10	dBm
Power dissipation	P_D	4-layer FR4 PCB with through-hole (74.2x74.2mm), $T_j=150^{\circ}\text{C}$	580	mW
Operating temperature	T_{opr}		-40 to +85	$^{\circ}\text{C}$
Storage temperature	T_{stg}		-55 to +150	$^{\circ}\text{C}$

■ ELECTRICAL CHARACTERISTICS1 (DC CHARACTERISTICS)

$V_{DD}=3.3\text{V}$, $T_a=+25^{\circ}\text{C}$, with application circuit

PARAMETERS	SYMBOL	CONDITIONS	MIN	TYP	MAX	UNITS
Operating voltage	V_{DD}		2.3	3.3	3.6	V
Control voltage (High)	$V_{CTL(H)}$		1.3	1.8	3.6	V
Control voltage (Low)	$V_{CTL(L)}$		0.0	0.0	0.5	V
Operating current1	I_{DD1}	RF OFF, $V_{CTL}=1.8\text{V}$	-	20	45	mA
Operating current2	I_{DD2}	RF OFF, $V_{CTL}=0\text{V}$	-	17	35	μA
Control current	I_{CTL}	RF OFF, $V_{CTL}=1.8\text{V}$	-	6	20	μA

■ ELECTRICAL CHARACTERISTICS2 (RF CHARACTERISTICS: LNA mode, 50Ω)

$V_{DD}=3.3V$, $V_{CTL}=1.8V$, freq=40 to 900MHz, $T_a=+25^{\circ}C$, $Z_S=Z_I=50\Omega$, with application circuit

PARAMETERS	SYMBOL	CONDITIONS	MIN	TYP	MAX	UNITS
Small signal gain1	Gain1	Exclude PCB & connector losses (Note1)	15.0	18.0	20.0	dB
Gain flatness1	Gflat1		-	1.0	2.0	dB
Noise figure1_1	NF1_1	freq=40 to 150MHz, Exclude PCB & connector losses (Note2)	-	1.2	2.0	dB
Noise figure1_2	NF1_2	freq=150 to 900MHz, Exclude PCB & connector losses (Note2)	-	0.9	1.4	dB
Input power 1dB compression1	P-1dB(IN)1		-10.0	-5.0	-	dBm
Input 3rd order intercept point1	IIP3_1	f1=freq, f2=freq+100kHz, $P_{IN}=-20dBm$	+0.0	+7.0	-	dBm
2nd order intermodulation distortion1	IM2_1	f1=200MHz, f2=500MHz, fmeas=700MHz, $P_{IN1}=P_{IN2}=-15dBm$	18.0	28.0	-	dB
3rd order intermodulation distortion1	IM3_1	f1=600MHz, f2=650MHz, fmeas=700MHz, $P_{IN1}=P_{IN2}=-15dBm$	35.0	45.0	-	dB
Isolation1	ISL1		15.0	19.0	-	dB
RFIN VSWR1	VSWRi1		-	2.5	4.0	-
RFOUT VSWR1	VSWRo1		-	1.5	2.4	-

(Note1) Input and output PCB, connector losses: 0.014dB(40MHz), 0.088dB(620MHz), 0.121dB(900MHz)

(Note2) Input PCB and connector losses: 0.007dB(40MHz), 0.044dB(620MHz), 0.060dB(900MHz)

■ ELECTRICAL CHARACTERISTICS3 (RF CHARACTERISTICS: Bypass mode, 50Ω)

$V_{DD}=3.3V$, $V_{CTL}=0V$, freq=40 to 900MHz, $T_a=+25^{\circ}C$, $Z_S=Z_I=50\Omega$, with application circuit

PARAMETERS	SYMBOL	CONDITIONS	MIN	TYP	MAX	UNITS
Insertion loss2	LOSS2	Exclude PCB & connector losses (Note1)	-	1.0	3.0	dB
Input power 1dB compression2	P-1dB(IN)2		+8.0	+15.0	-	dBm
Input 3rd order intercept point2	IIP3_2	f1=freq, f2=freq+100kHz, P _{IN} =-2dBm	+22.0	+30.0		dBm
2nd order intermodulation distortion2	IM2_2	f1=200MHz, f2=500MHz, fmeas=700MHz, P _{IN1} =P _{IN2} =-8dBm	60.0	75.0	-	dB
3rd order intermodulation distortion2	IM3_2	f1=600MHz, f2=650MHz, fmeas=700MHz, P _{IN1} =P _{IN2} =-8dBm	70.0	85.0	-	dB
RFIN VSWR2	VSWRi2		-	1.5	2.5	-
RFOUT VSWR2	VSWRo2		-	1.5	2.5	-

(Note1) Input and output PCB, connector losses: 0.014dB(40MHz), 0.088dB(620MHz), 0.121dB(900MHz)

■ ELECTRICAL CHARACTERISTICS4 (RF CHARACTERISTICS: LNA mode, 75Ω)

$V_{DD}=3.3V$, $V_{CTL}=1.8V$, freq=40 to 900MHz, $T_a=+25^{\circ}C$, $Z_S=Z_I=75\Omega$, with application circuit

PARAMETERS	SYMBOL	CONDITIONS	MIN	TYP	MAX	UNITS
Small signal gain3	Gain3	Exclude PCB & connector losses	-	18.0	-	dB
RFIN VSWR3	VSWRi3		-	2.0	-	-
RFOUT VSWR3	VSWRo3		-	2.0	-	-

■ ELECTRICAL CHARACTERISTICS5 (RF CHARACTERISTICS: Bypass mode, 75Ω)

$V_{DD}=3.3V$, $V_{CTL}=0V$, freq=40 to 900MHz, $T_a=+25^{\circ}C$, $Z_S=Z_I=75\Omega$, with application circuit

PARAMETERS	SYMBOL	CONDITIONS	MIN	TYP	MAX	UNITS
Insertion loss4	LOSS4	Exclude PCB & connector losses	-	1.5	-	dB
Composite Second Order4	CSO4	132channels, CW, P _{IN} =+15dBmV	-	80	-	dBc
Composite Triple Beat4	CTB4	132channels, CW, P _{IN} =+15dBmV	-	80	-	dBc
RFIN VSWR4	VSWRi4		-	2.0	-	-
RFOUT VSWR4	VSWRo4		-	2.0	-	-

■ TERMINAL DESCRIPTION

Pin No.	SYMBOL	DESCRIPTION
1	RFOUT1	The RF output terminal of the LNA mode. This terminal doubles as the drain terminal of the LNA. Please connect this terminal to the power supply via choke inductor.
2	GND	Ground terminal. This terminal should be connected to the ground plane as close as possible for excellent RF performance.
3	RFOUT2	The RF output terminal of the Bypass mode. Please connect this terminal with RFOUT1 terminal through DC blocking capacitor shown in the application circuit.
4	RFIN	RF input terminal. External capacitor C1 is required to block the DC bias voltage of internal circuit.
5	GND	Ground terminal. This terminal should be connected to the ground plane as close as possible for excellent RF performance.
6	VCTL	Control voltage terminal. At this terminal, the switching of the LNA mode and Bypass mode is possible.

■ ELECTRICAL CHARACTERISTICS (LNA mode, 50Ω)

Conditions: $V_{DD}=3.3V$, $V_{CTL}=1.8V$, $T_a=25^\circ C$, $Z_s=Z_l=50\Omega$, with application circuit

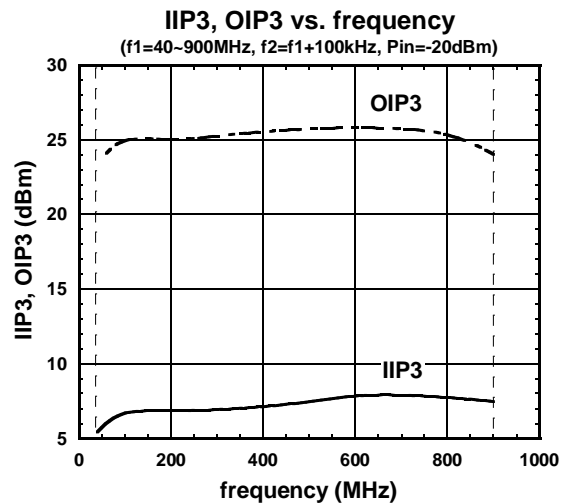
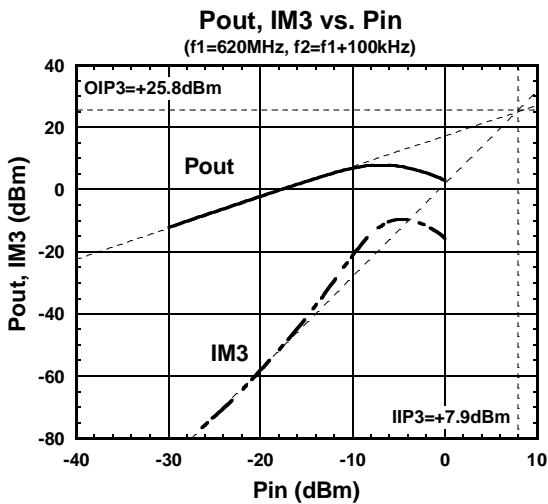
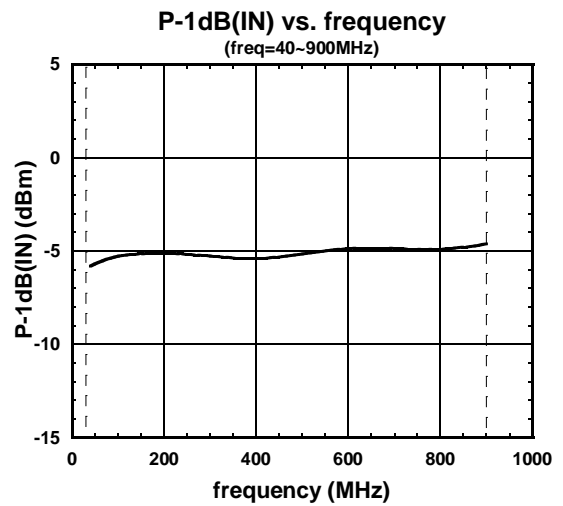
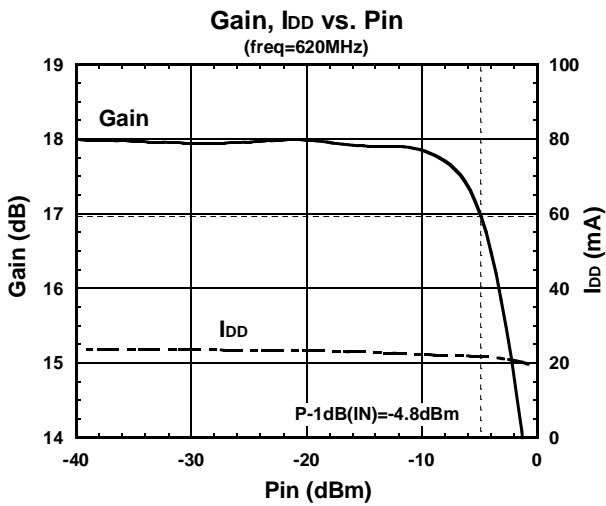
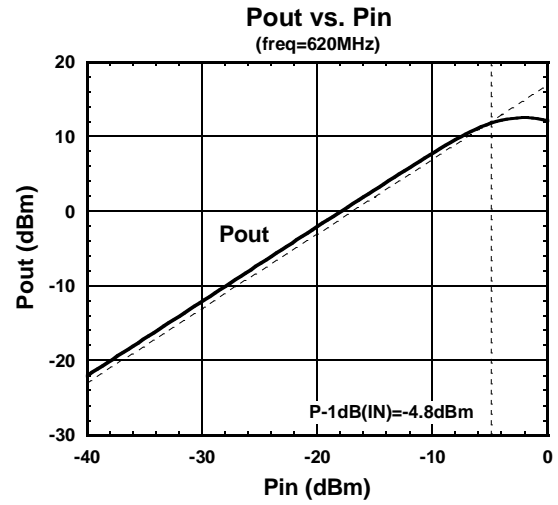
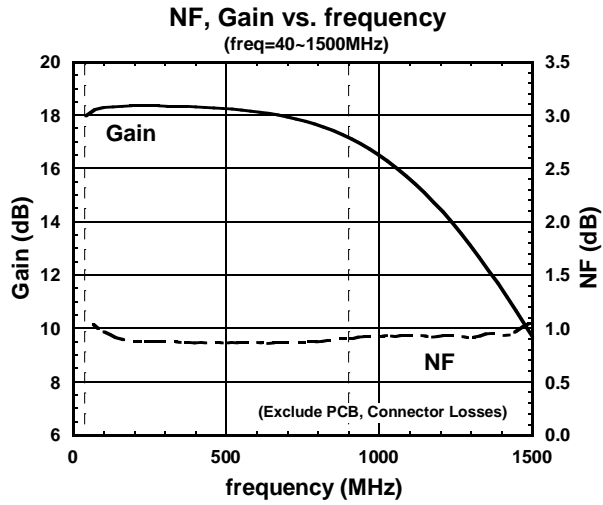

■ ELECTRICAL CHARACTERISTICS (LNA mode, 50Ω)

Conditions: $V_{DD}=3.3V$, $V_{CTL}=1.8V$, $T_a=25^{\circ}C$, $Z_s=Z_l=50\Omega$, with application circuit

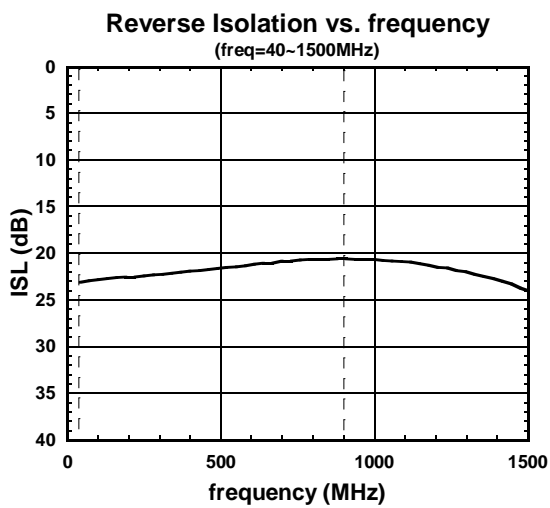
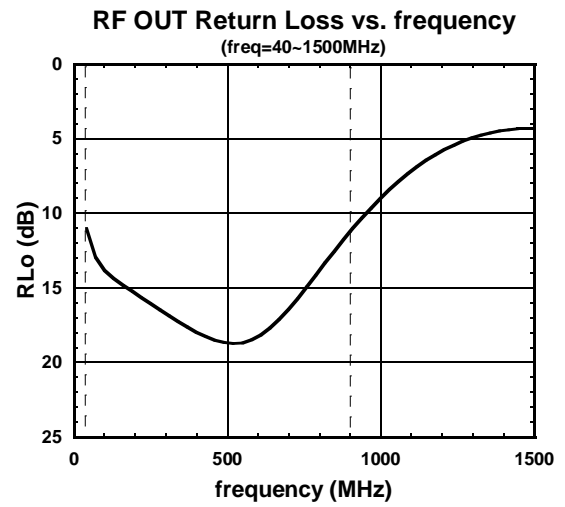
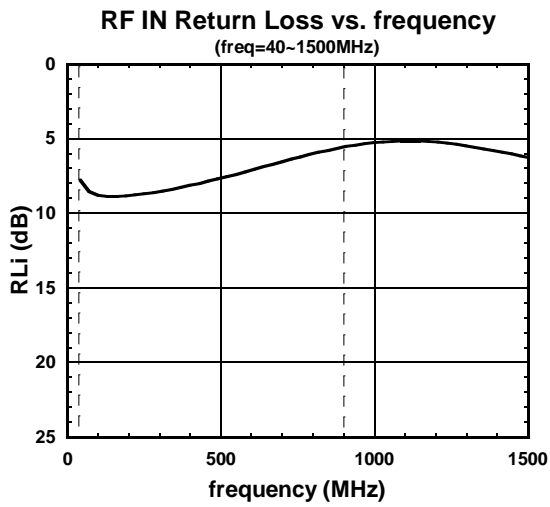

ELECTRICAL CHARACTERISTICS (LNA mode, 50Ω)

Conditions: $V_{DD}=3.3V$, $V_{CTL}=1.8V$, $T_a=25^{\circ}C$, $Z_s=Z_l=50\Omega$, with application circuit

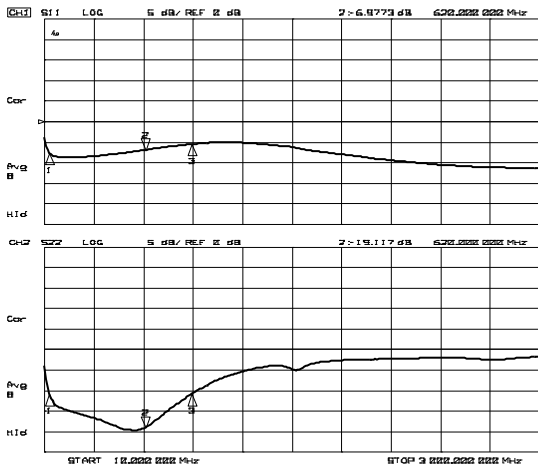

S11, S22

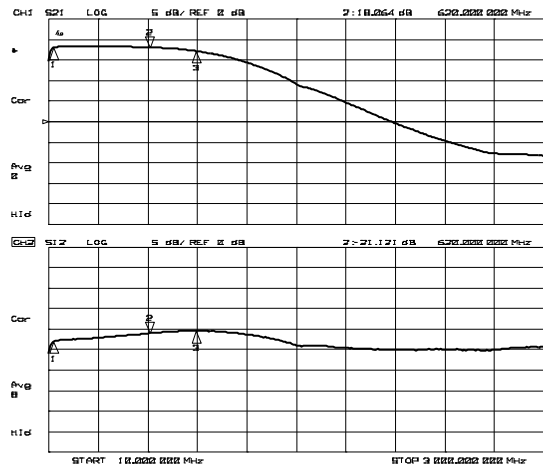

S21, S12

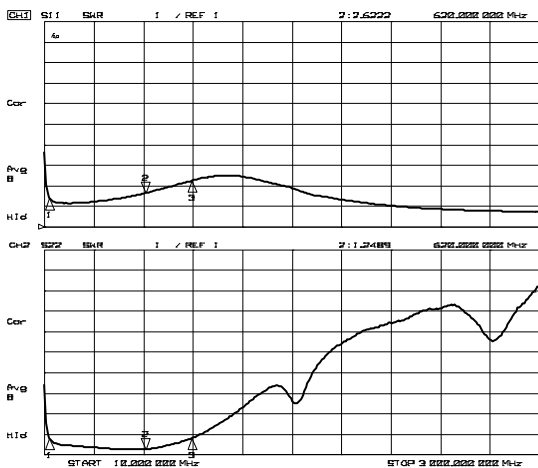

VSWRi, VSWRo

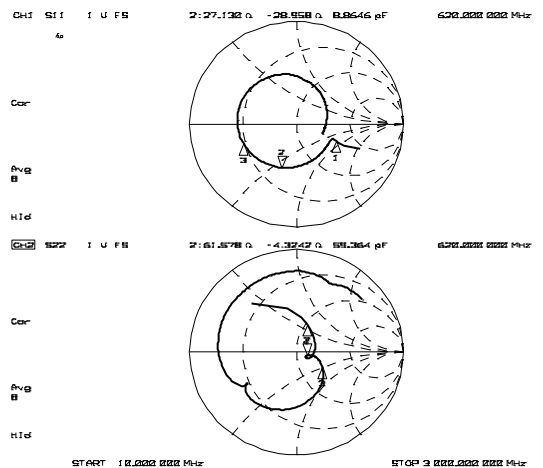

Zin, Zout

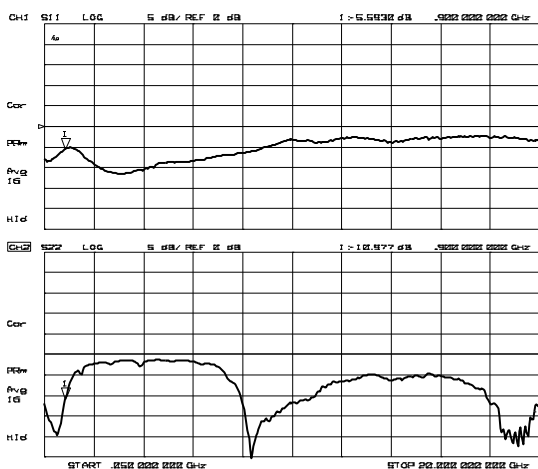

S11, S22 50MHz to 20GHz

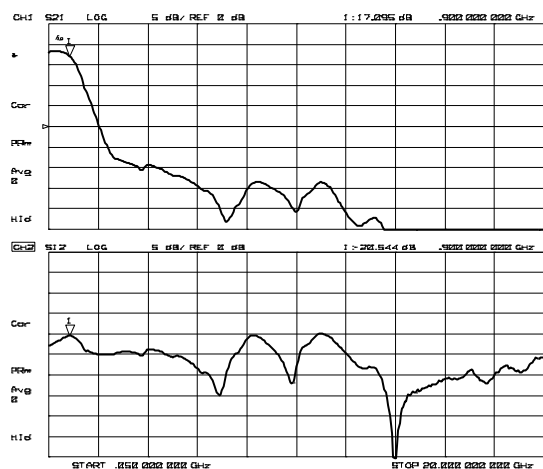

S21, S12 50MHz to 20GHz

■ ELECTRICAL CHARACTERISTICS (LNA mode, 50Ω)

Conditions: $V_{CTL}=1.8V$, $T_a=25^\circ C$, $Z_s=Z_L=50\Omega$, with application circuit

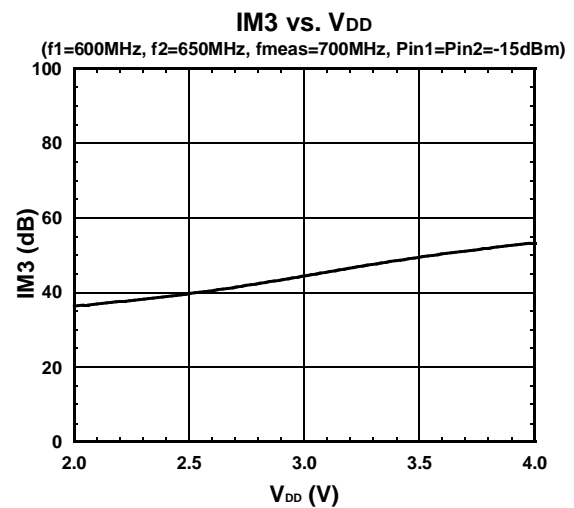
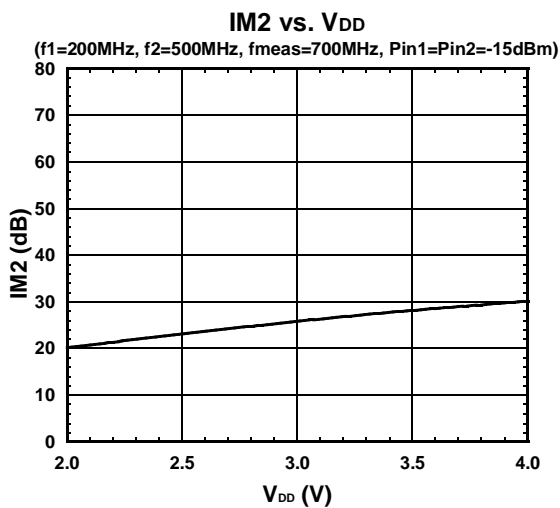
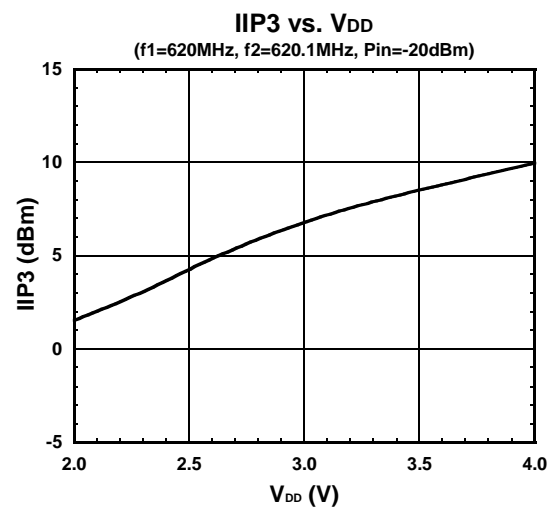
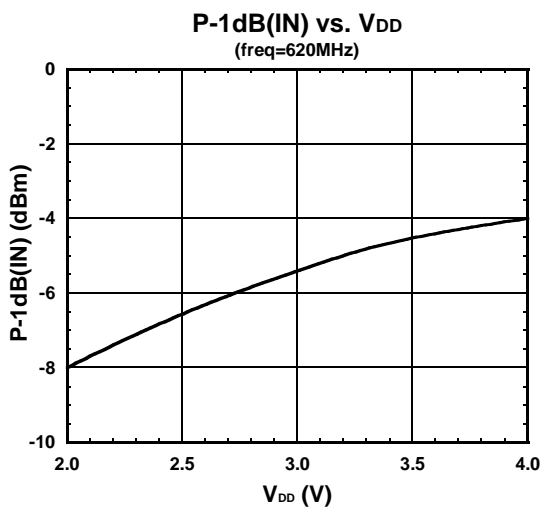
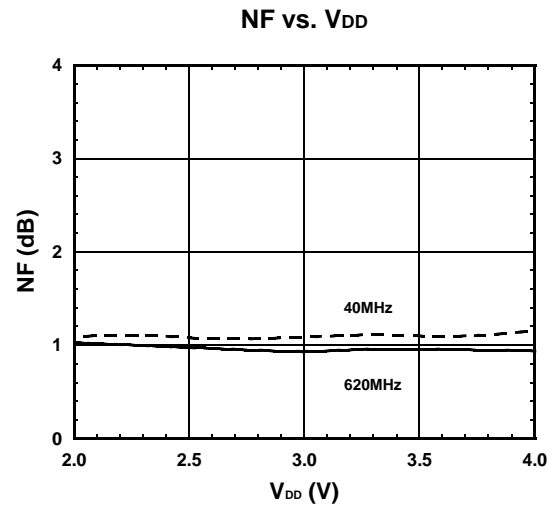
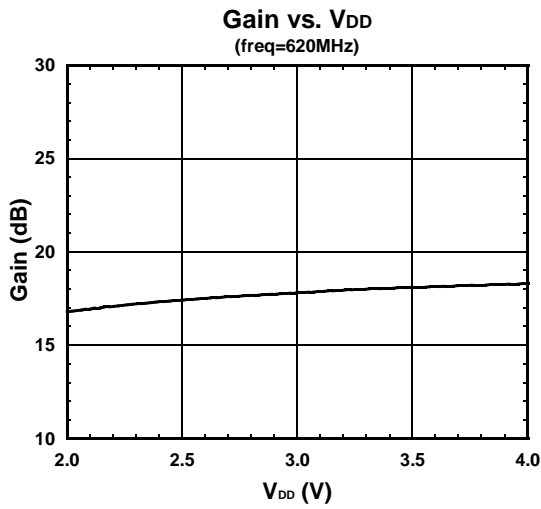

■ ELECTRICAL CHARACTERISTICS (LNA mode, 50Ω)

Conditions: $V_{CTL}=1.8V$, $T_a=25^\circ C$, $Z_s=Z_l=50\Omega$, with application circuit

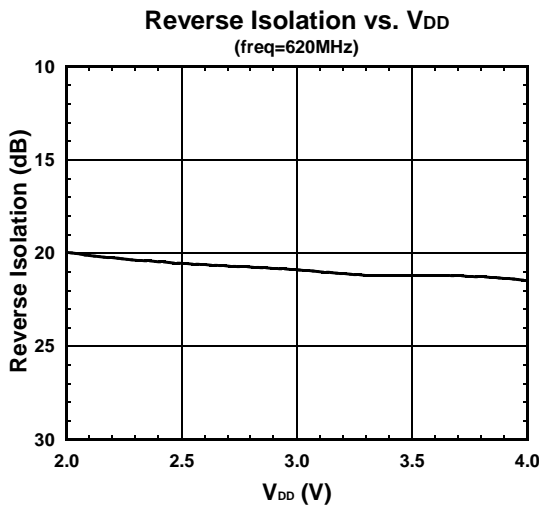
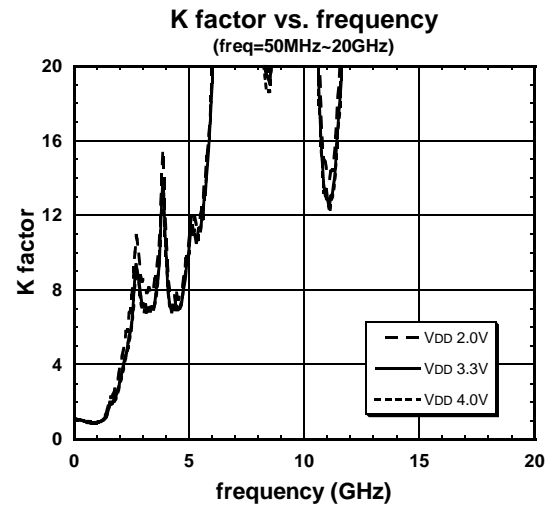
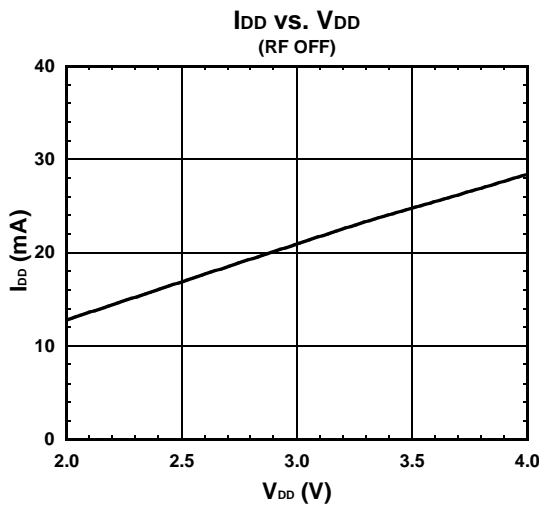
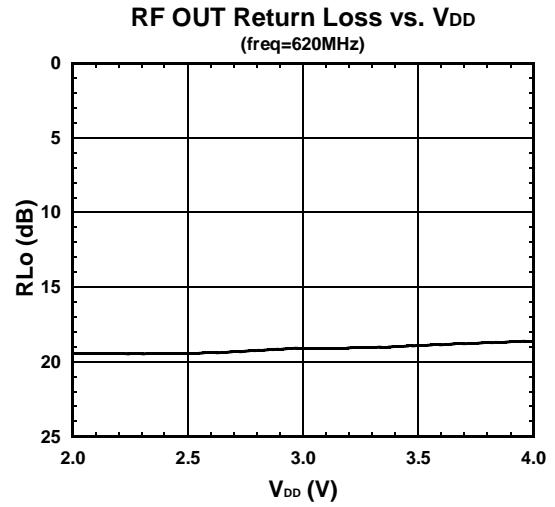
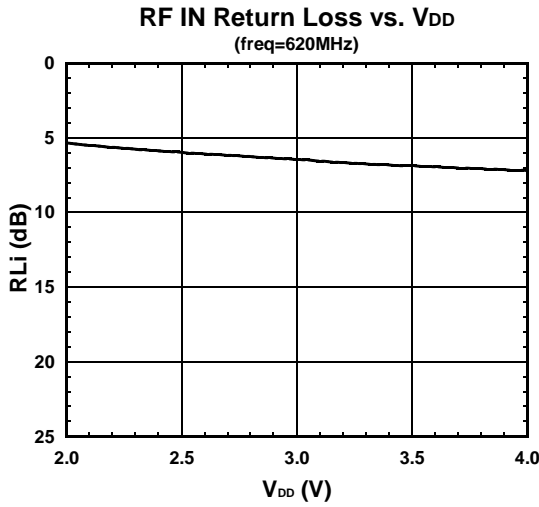

■ ELECTRICAL CHARACTERISTICS (LNA mode, 50Ω)

Conditions: $V_{DD}=3.3V$, $V_{CTL}=1.8V$, $Z_s=Z_l=50\Omega$, with application circuit

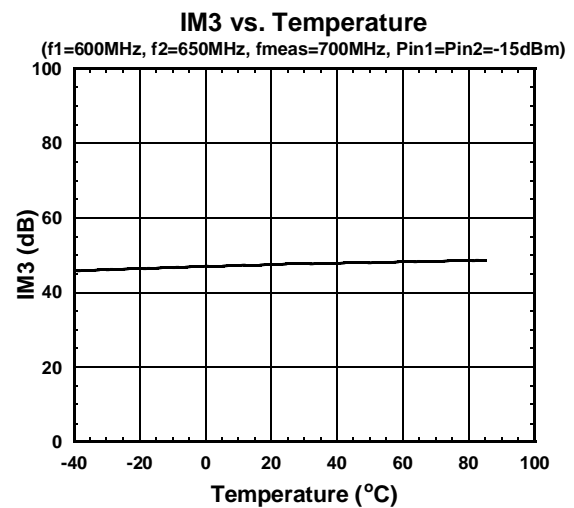
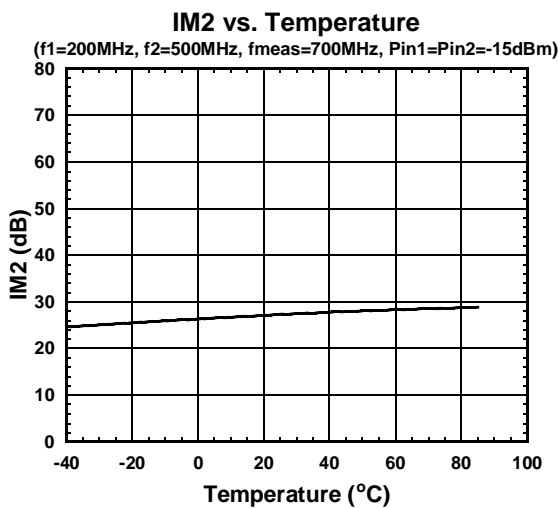
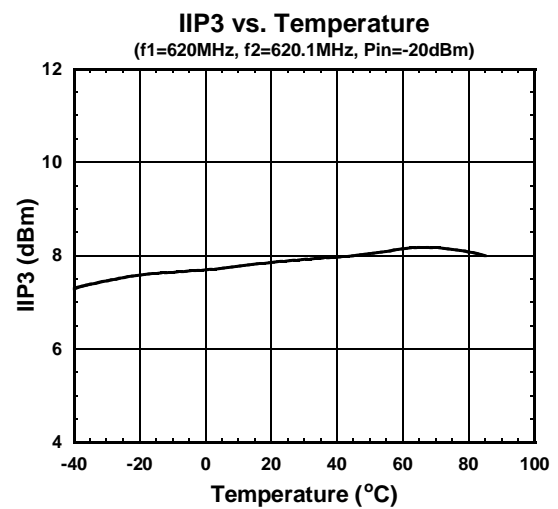
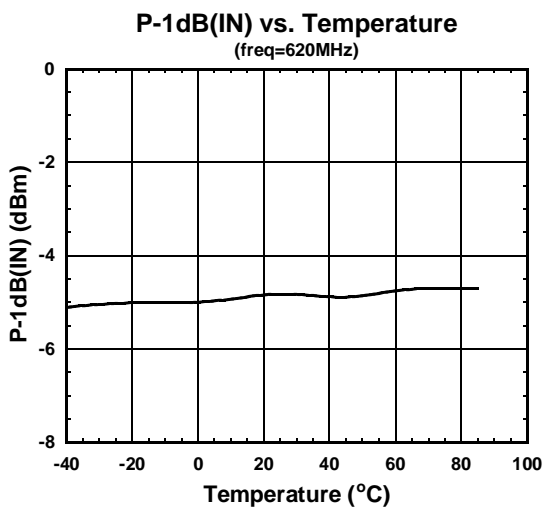
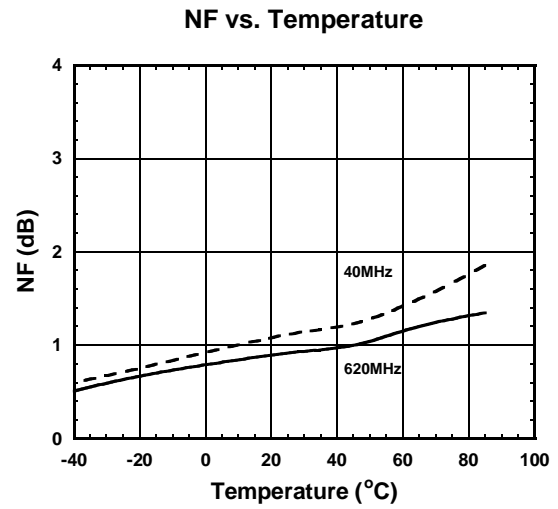
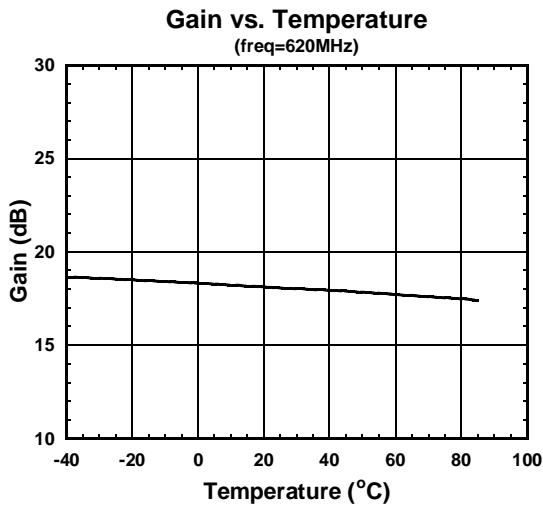

■ ELECTRICAL CHARACTERISTICS (LNA mode, 50Ω)

Conditions: $V_{DD}=3.3V$, $V_{CTL}=1.8V$, $Z_s=Z_l=50\Omega$, with application circuit

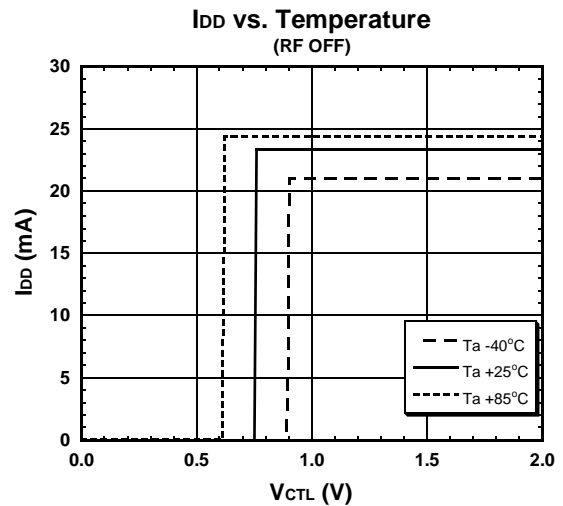
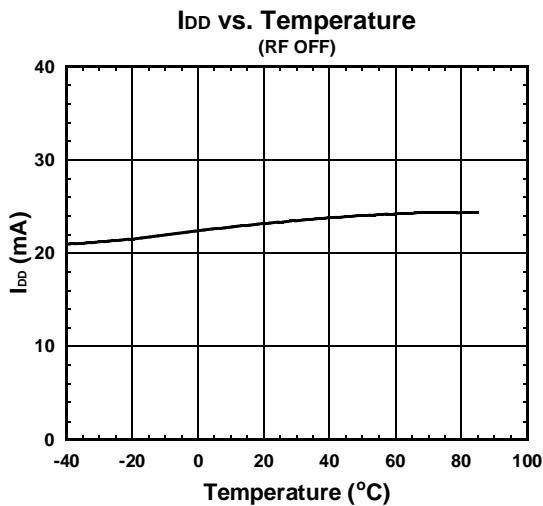
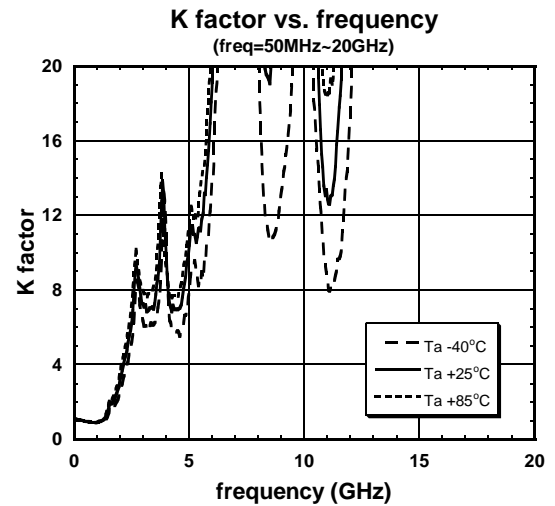
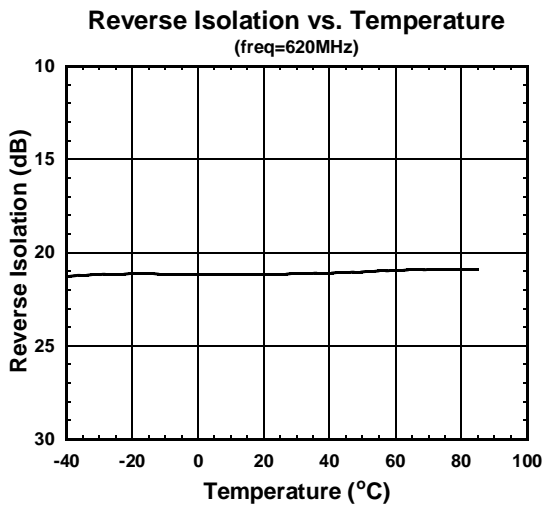
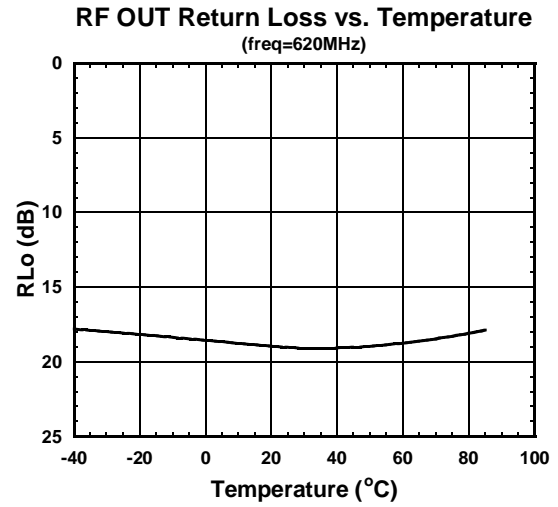
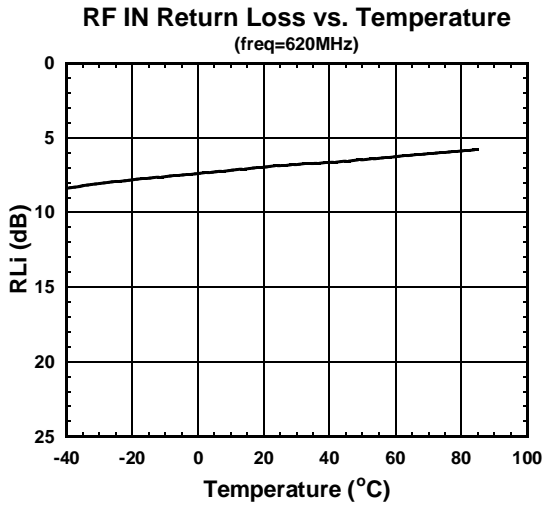

■ ELECTRICAL CHARACTERISTICS (Bypass mode, 50Ω)

Conditions: $V_{DD}=3.3V$, $V_{CTL}=0V$, $T_a=25^\circ C$, $Z_s=Z_l=50\Omega$, with application circuit

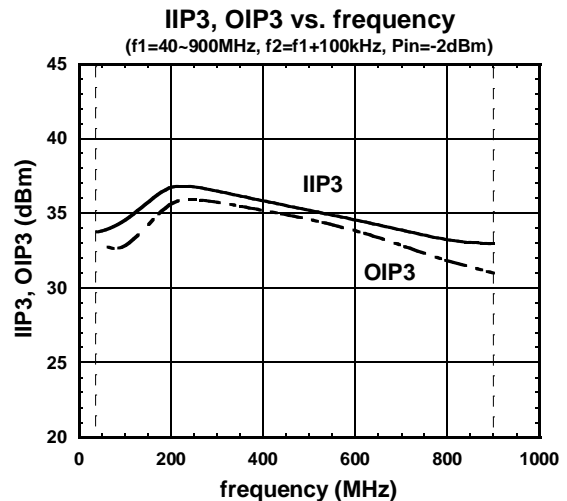
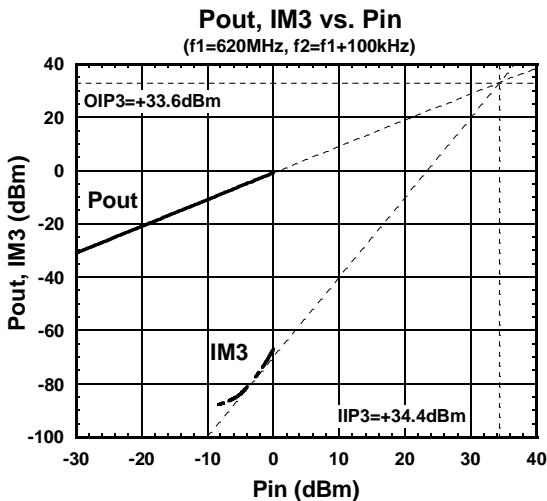
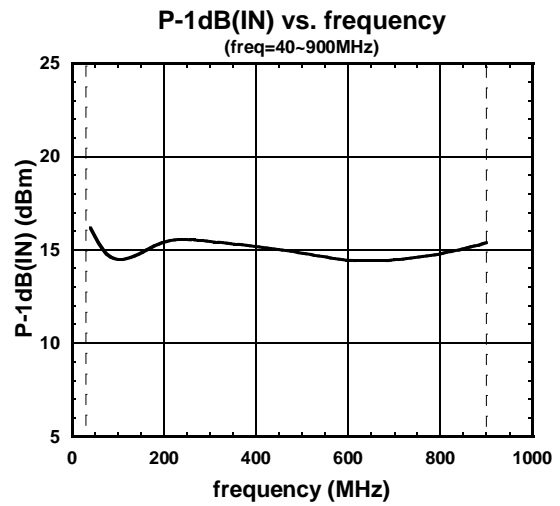
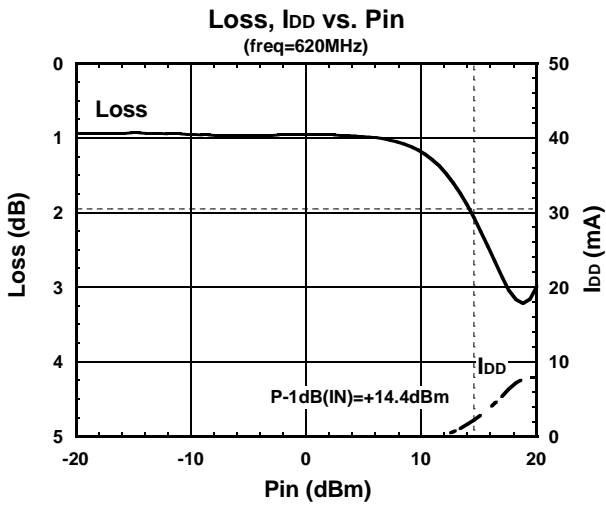
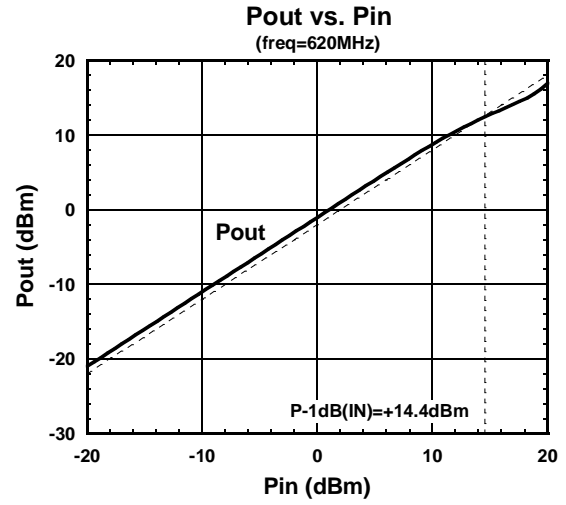
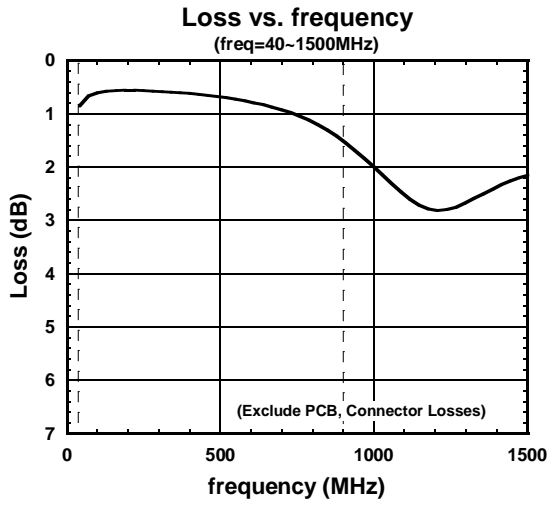

■ ELECTRICAL CHARACTERISTICS (Bypass mode, 50Ω)

Conditions: $V_{DD}=3.3V$, $V_{CTL}=0V$, $T_a=25^\circ C$, $Z_s=Z_l=50\Omega$, with application circuit

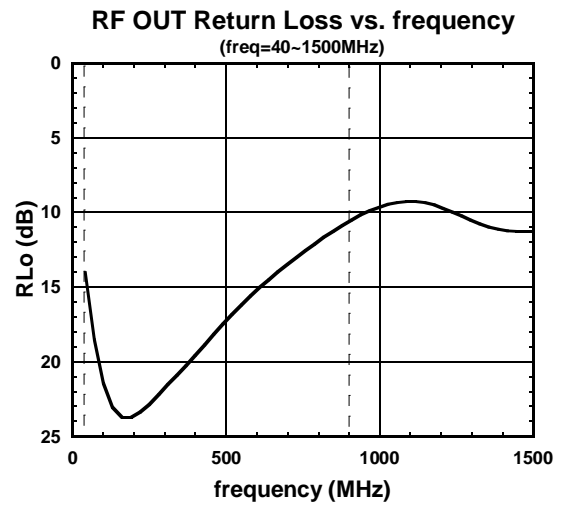
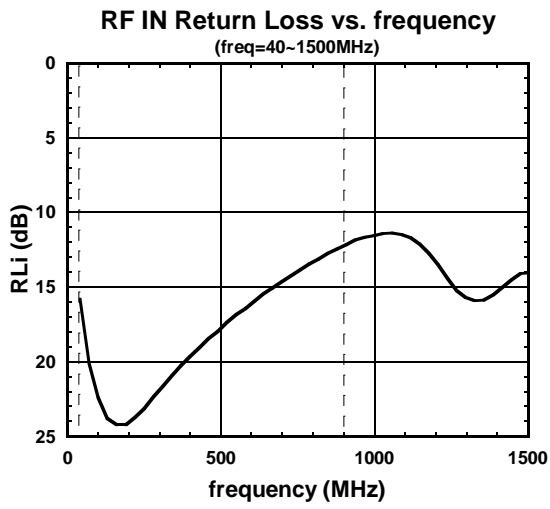

ELECTRICAL CHARACTERISTICS (Bypass mode, 50Ω)

Conditions: $V_{DD}=3.3V$, $V_{CTL}=0V$, $Z_s=Z_l=50\Omega$, with application circuit

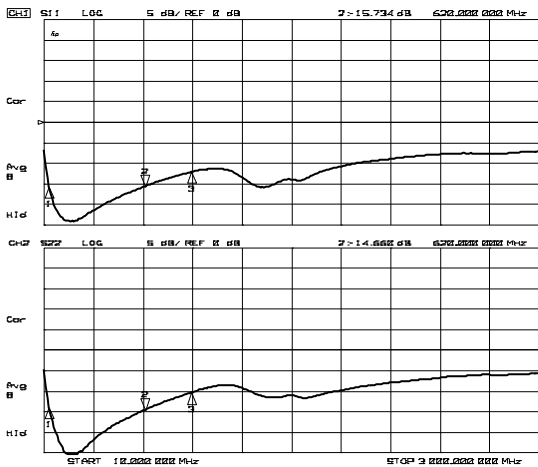

S11, S22

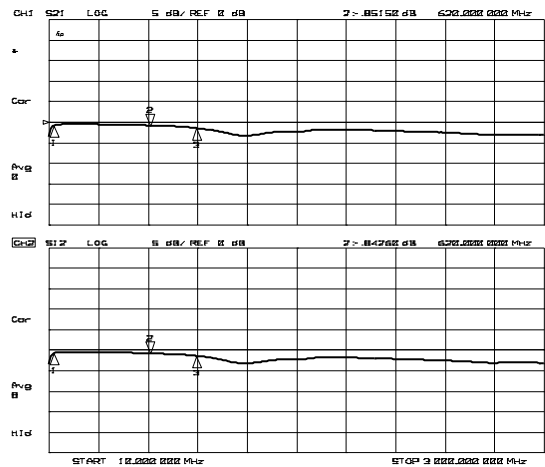

S21, S12

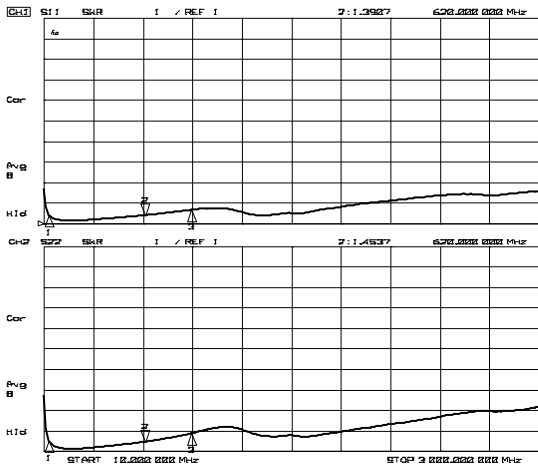

VSWRi, VSWRo

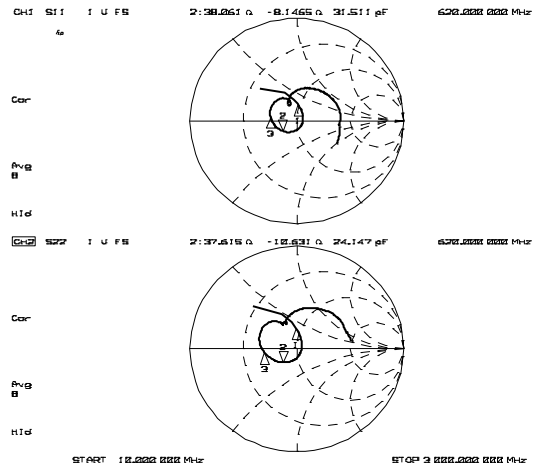

Zin, Zout

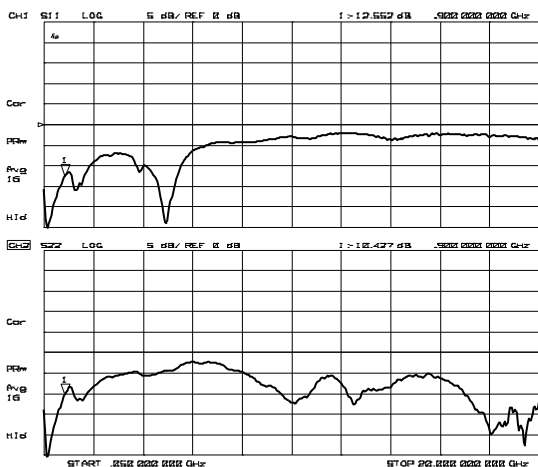

S11, S22 50MHz to 20GHz

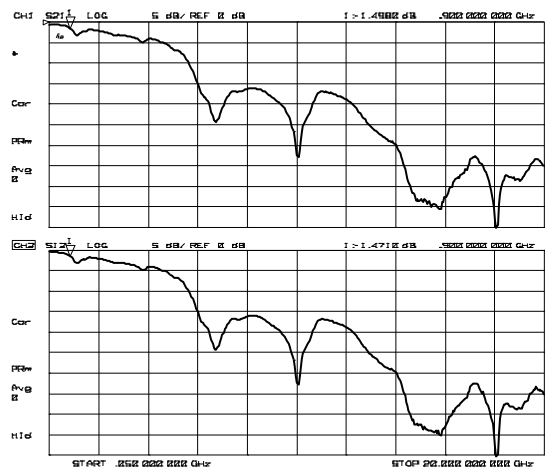

S21, S12 50MHz to 20GHz

■ ELECTRICAL CHARACTERISTICS (Bypass mode, 50Ω)

Conditions: $V_{CTL}=0V$, $T_a=25^\circ C$, $Z_s=Z_l=50\Omega$, with application circuit

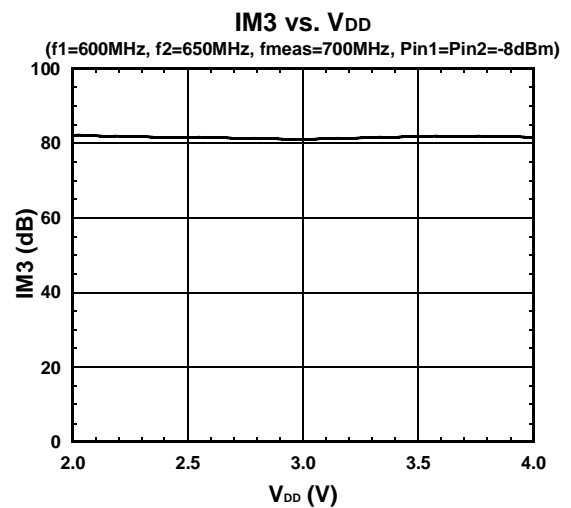
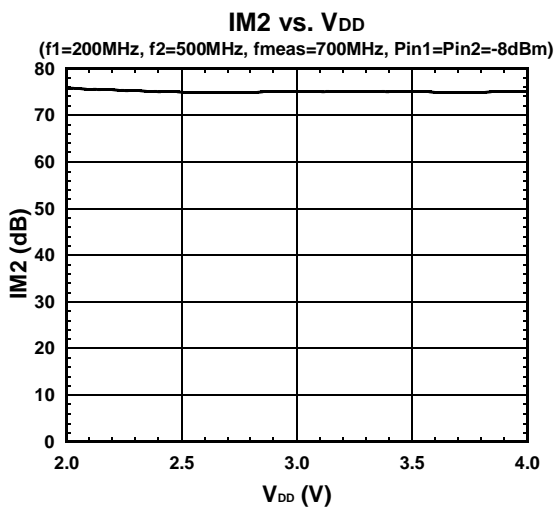
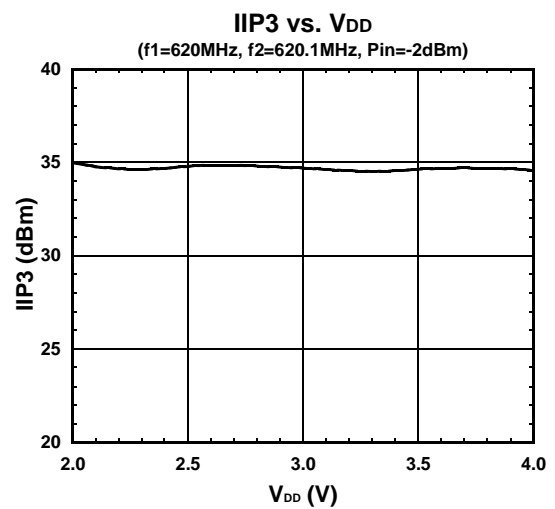
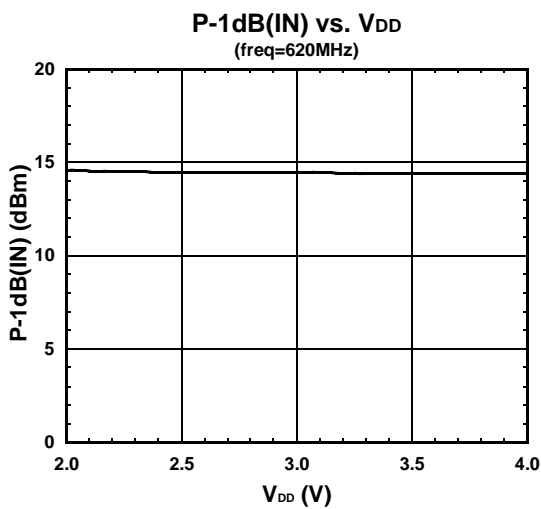
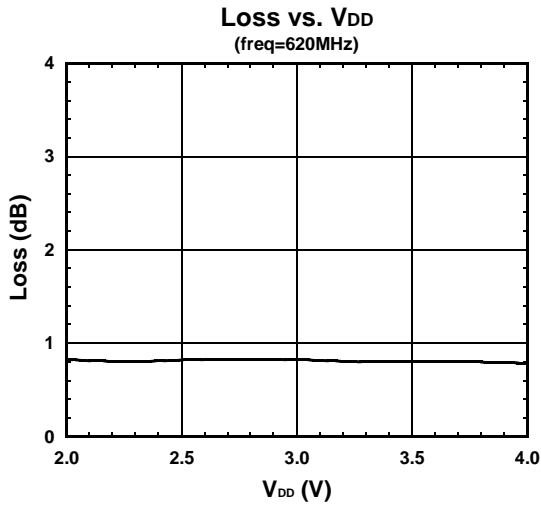

■ ELECTRICAL CHARACTERISTICS (Bypass mode, 50Ω)

Conditions: $V_{CTL}=0V$, $T_a=25^\circ C$, $Z_s=Z_l=50\Omega$, with application circuit

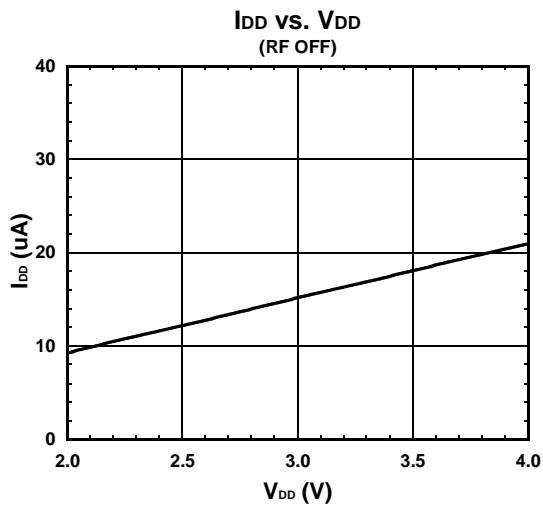
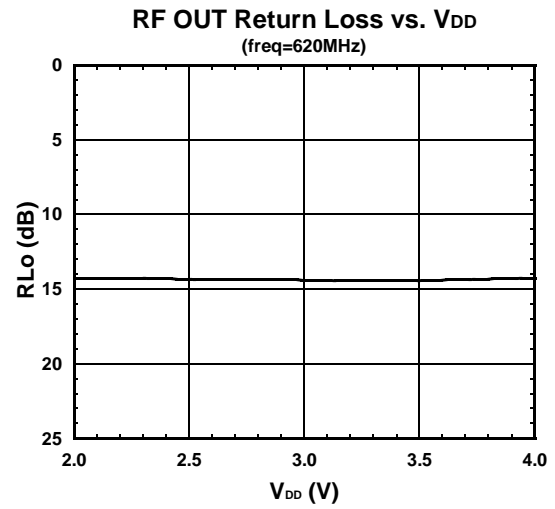
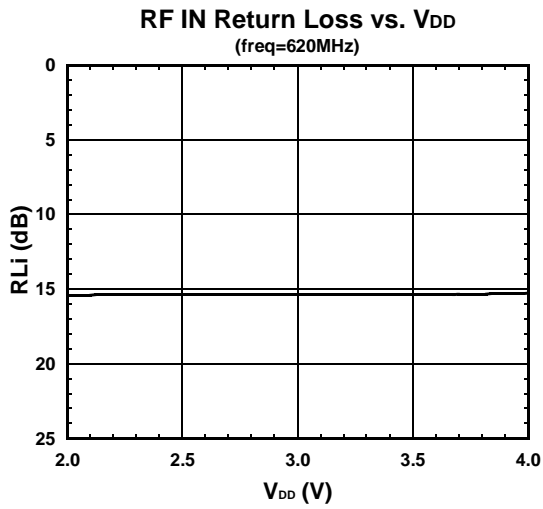

■ ELECTRICAL CHARACTERISTICS (Bypass mode, 50Ω)

Conditions: $V_{DD}=3.3V$, $V_{CTL}=0V$, $Z_s=Z_l=50\Omega$, with application circuit

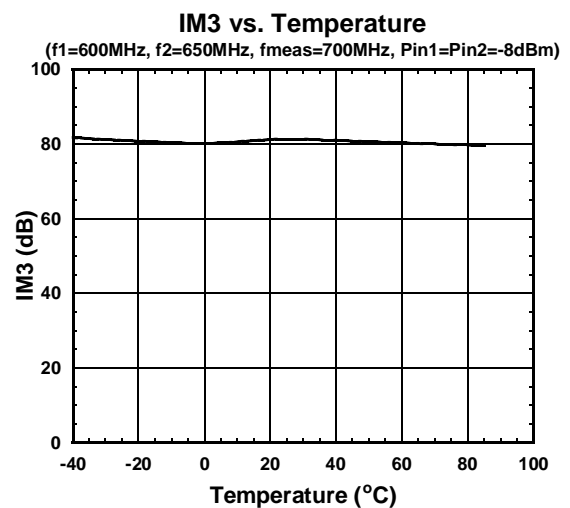
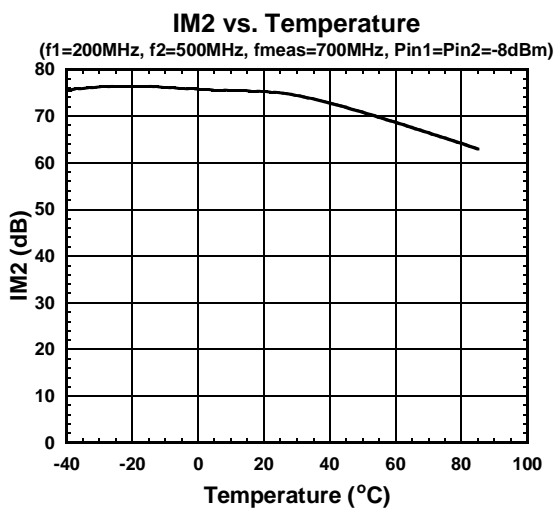
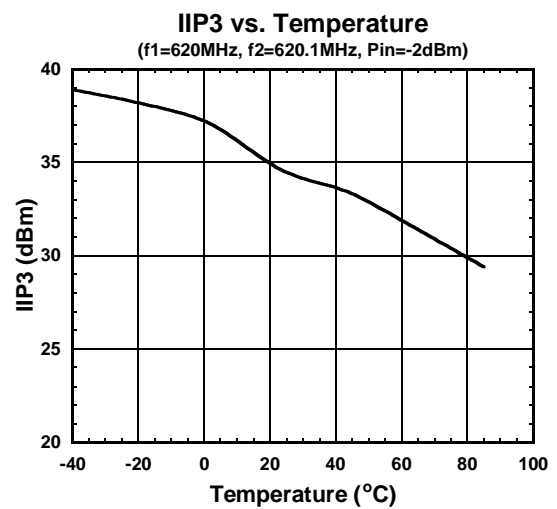
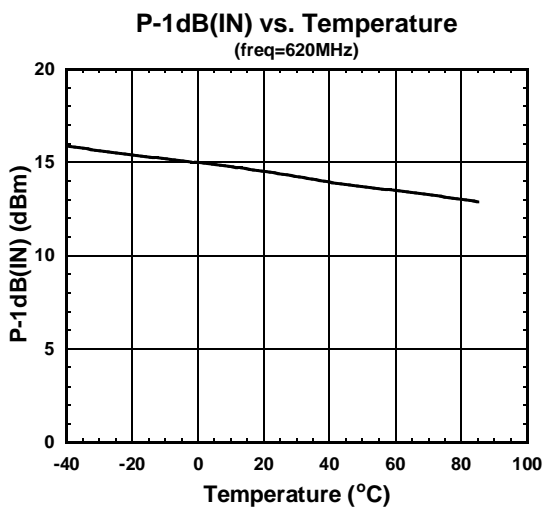
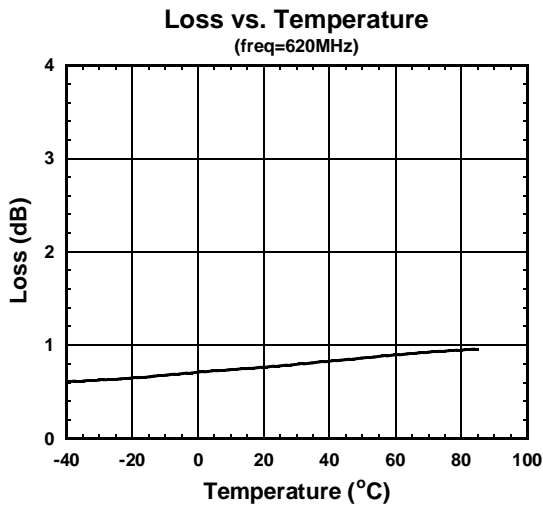

■ ELECTRICAL CHARACTERISTICS (Bypass mode, 50Ω)

Conditions: $V_{DD}=3.3V$, $V_{CTL}=0V$, $Z_s=Z_l=50\Omega$, with application circuit

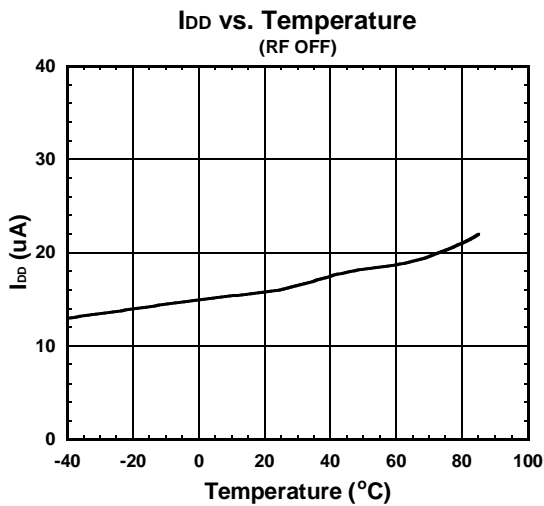
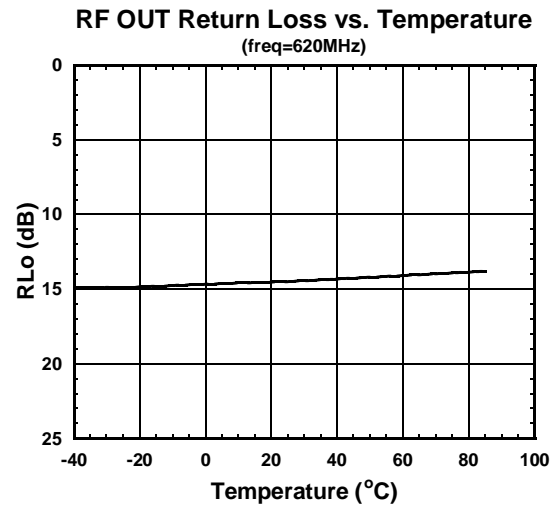
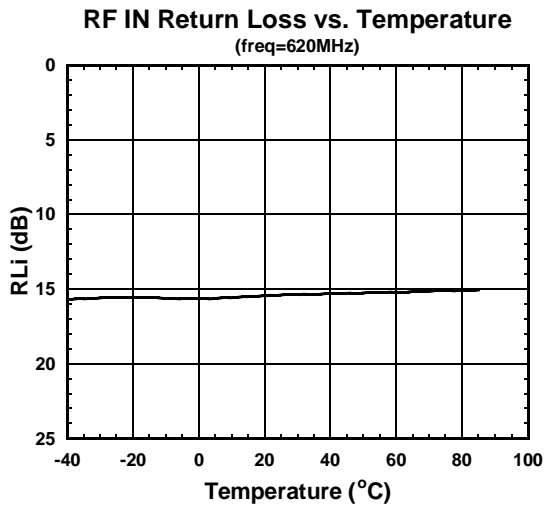

■ ELECTRICAL CHARACTERISTICS (LNA mode, 75Ω)

Conditions: $V_{DD}=3.3V$, $V_{CTL}=1.8V$, $T_a=25^{\circ}C$, $Z_s=Z_l=75\Omega$, with application circuit

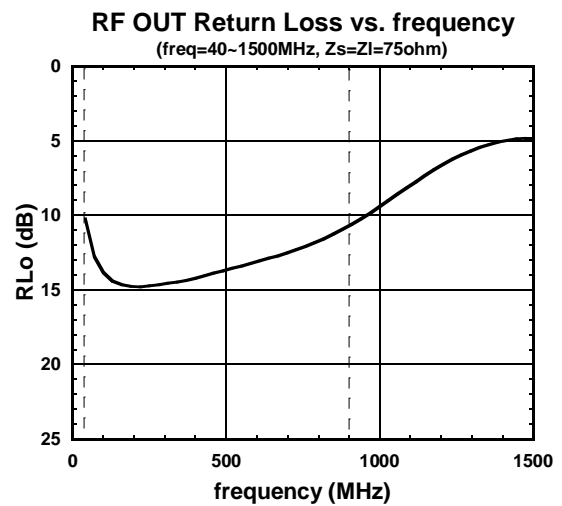
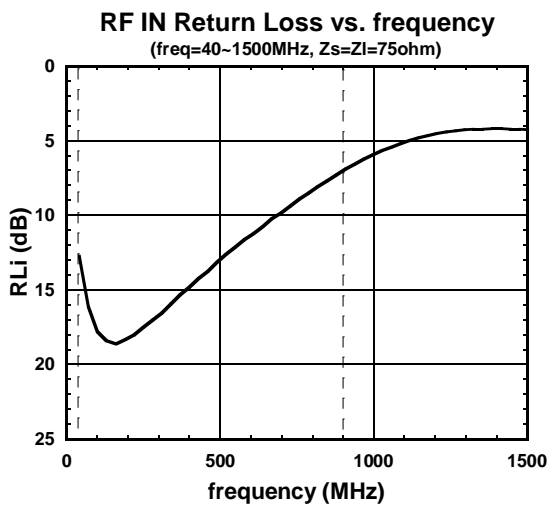
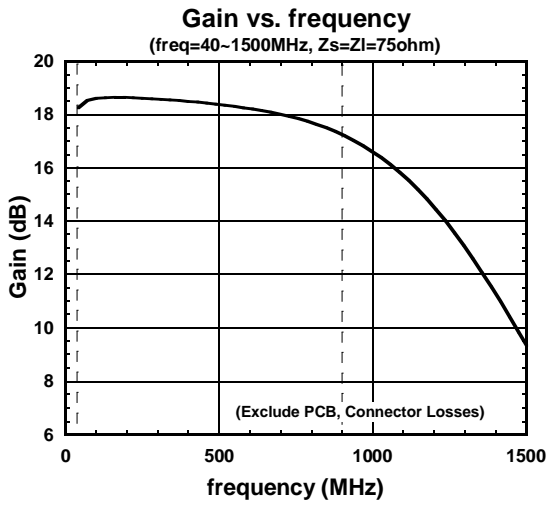

■ ELECTRICAL CHARACTERISTICS (LNA mode, 75Ω)

Conditions: $V_{CTL}=1.8V$, $T_a=25^{\circ}C$, $Z_s=Z_l=75\Omega$, with application circuit

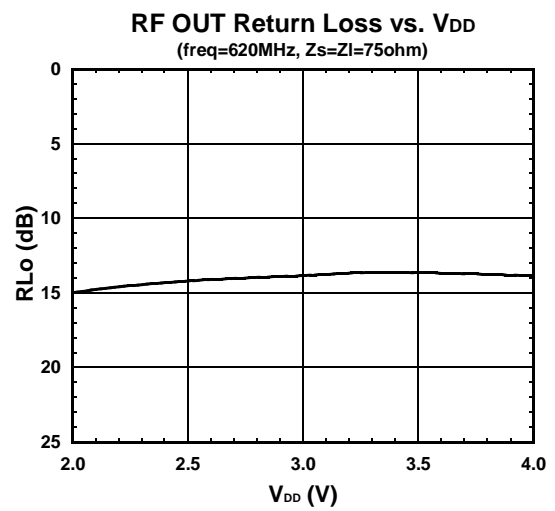
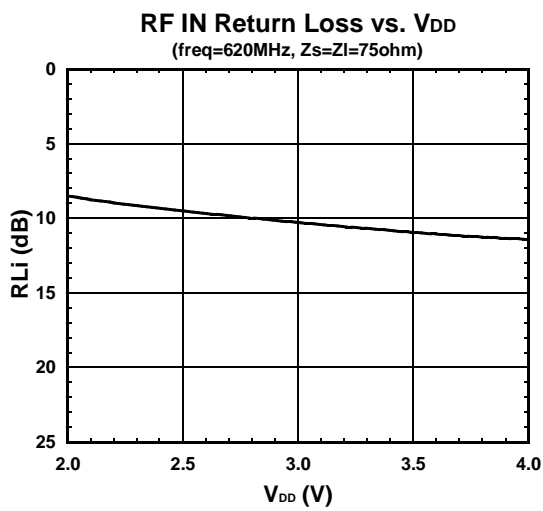
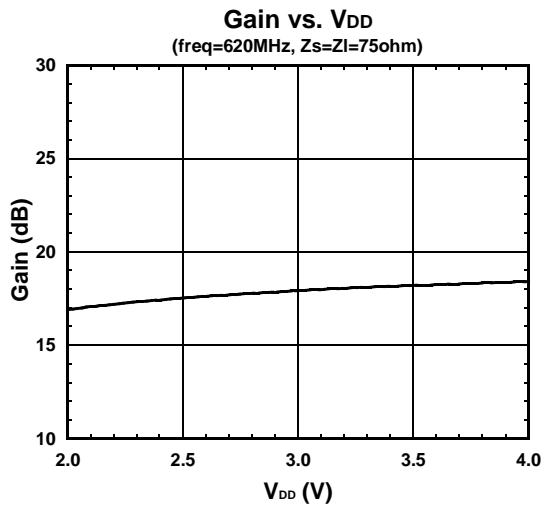

■ ELECTRICAL CHARACTERISTICS (LNA mode, 75Ω)

Conditions: $V_{DD}=3.3V$, $V_{CTL}=1.8V$, $Z_s=Z_l=75\Omega$, with application circuit

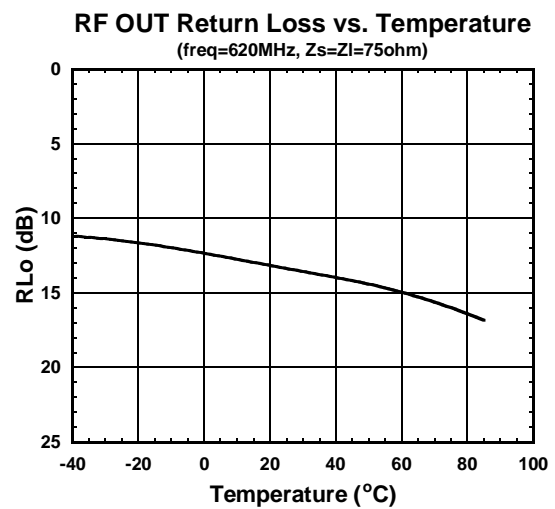
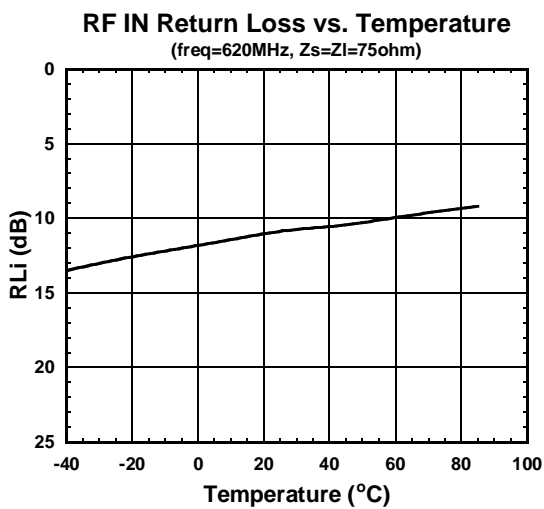
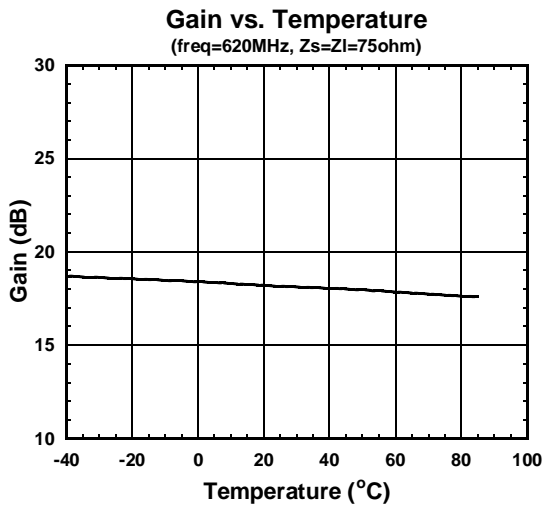

■ ELECTRICAL CHARACTERISTICS (Bypass mode, 75Ω)

Conditions: $V_{DD}=3.3V$, $V_{CTL}=0V$, $T_a=25^{\circ}C$, $Z_s=Z_l=75\Omega$, with application circuit

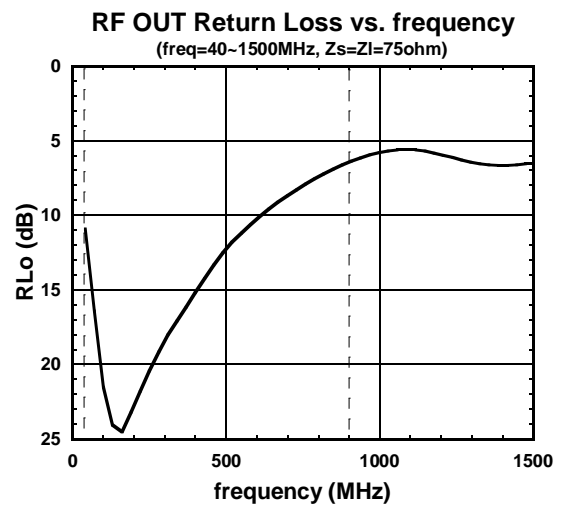
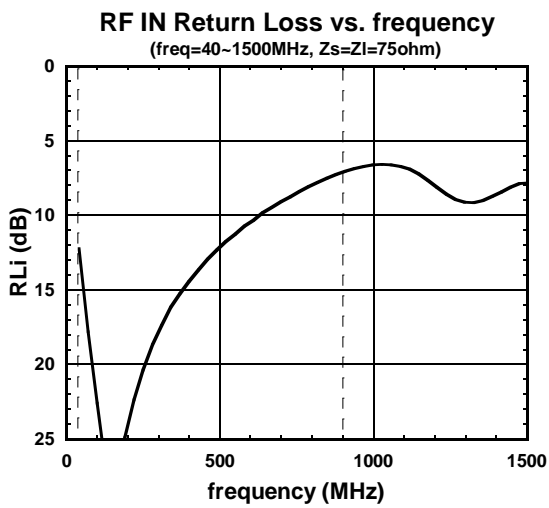
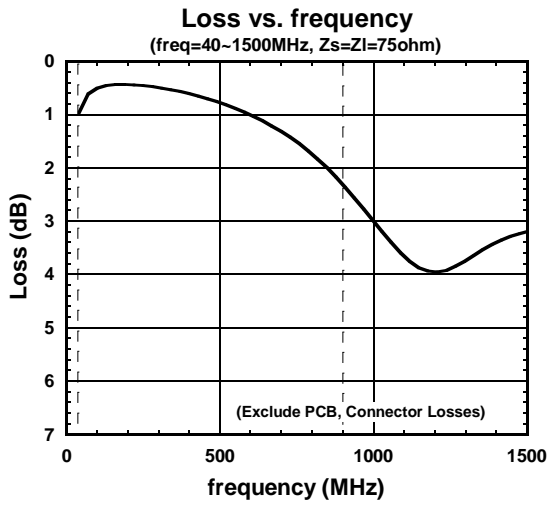

■ ELECTRICAL CHARACTERISTICS (Bypass mode, 75Ω)

Conditions: $V_{CTL}=0V$, $T_a=25^\circ C$, $Z_s=Z_l=75\Omega$, with application circuit

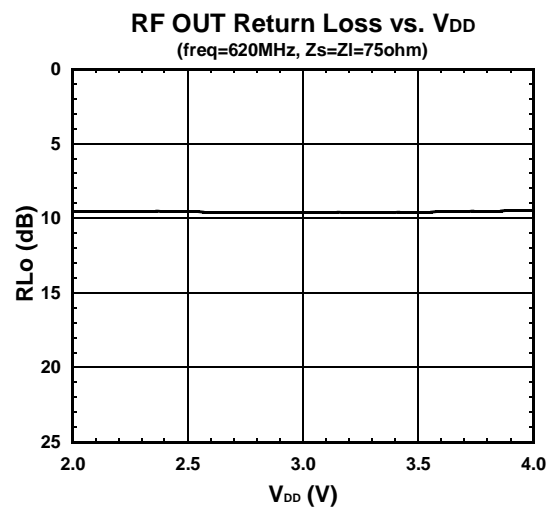
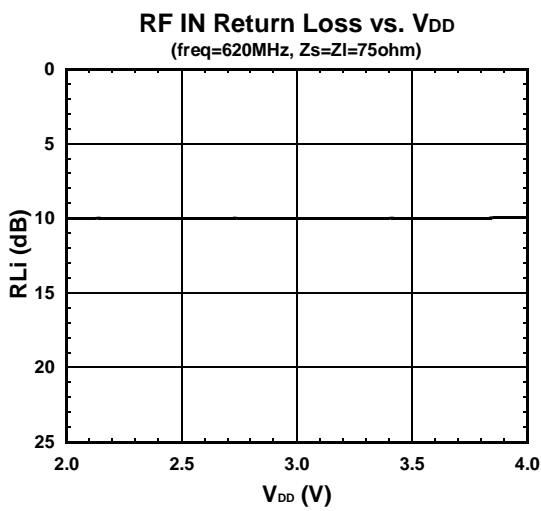
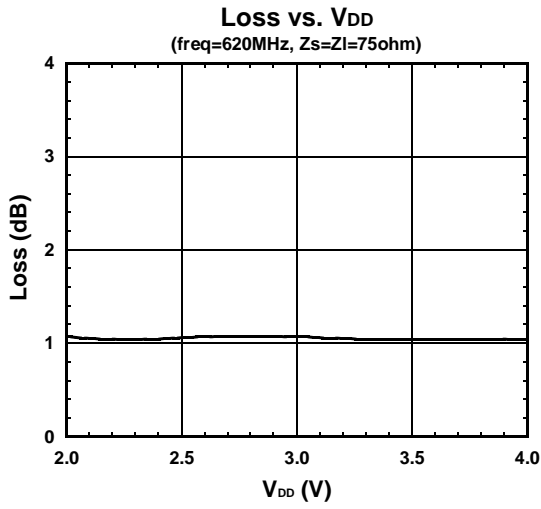

■ ELECTRICAL CHARACTERISTICS (Bypass mode, 75Ω)

Conditions: $V_{DD}=3.3V$, $V_{CTL}=0V$, $Z_s=Z_l=75\Omega$, with application circuit

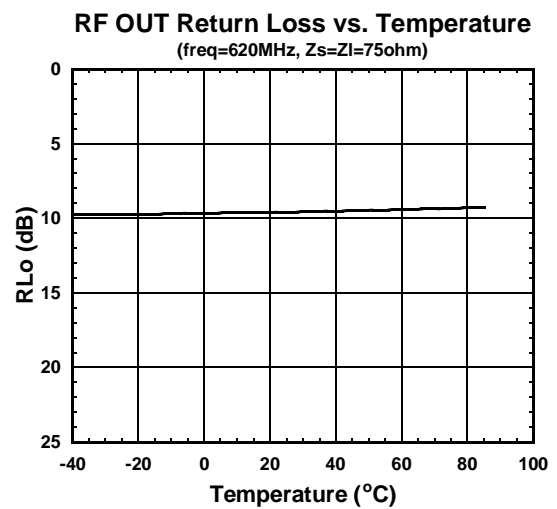
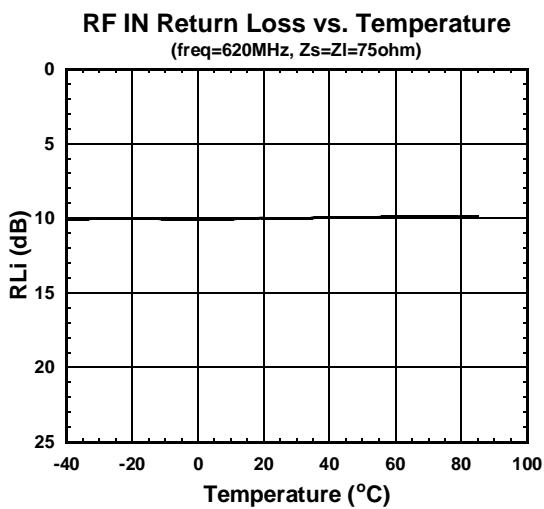
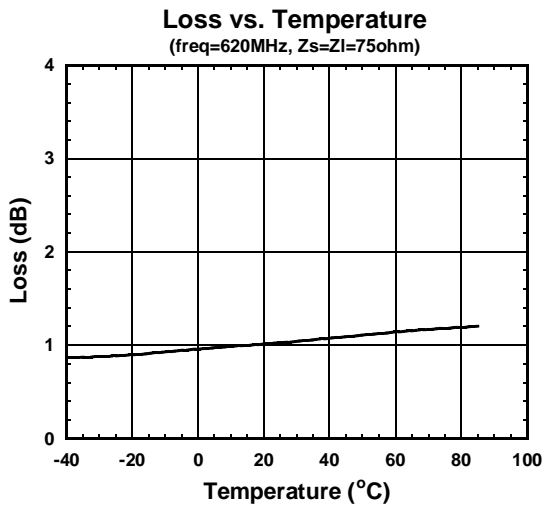

APPLICATION CIRCUIT

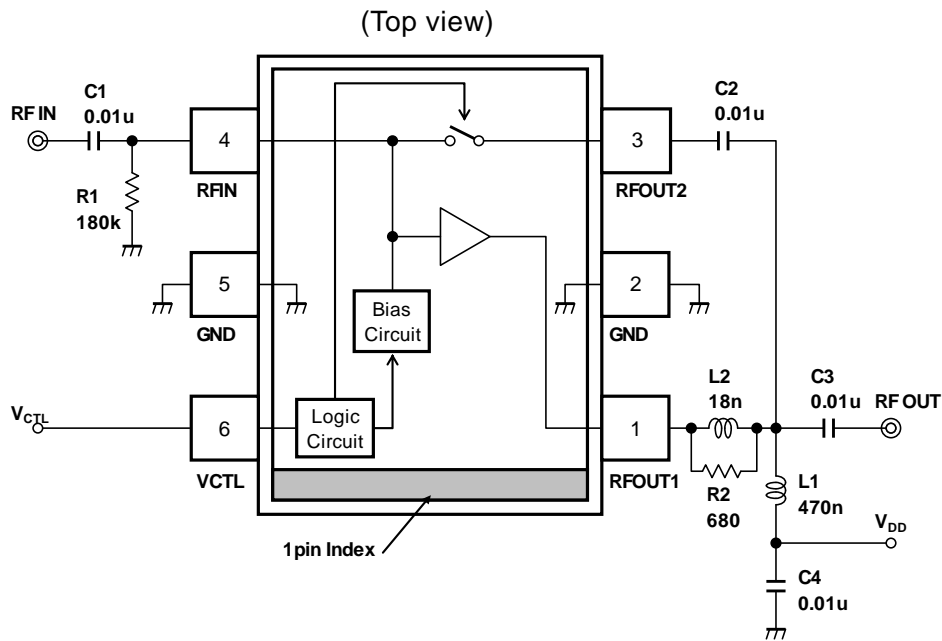

TEST PCB LAYOUT

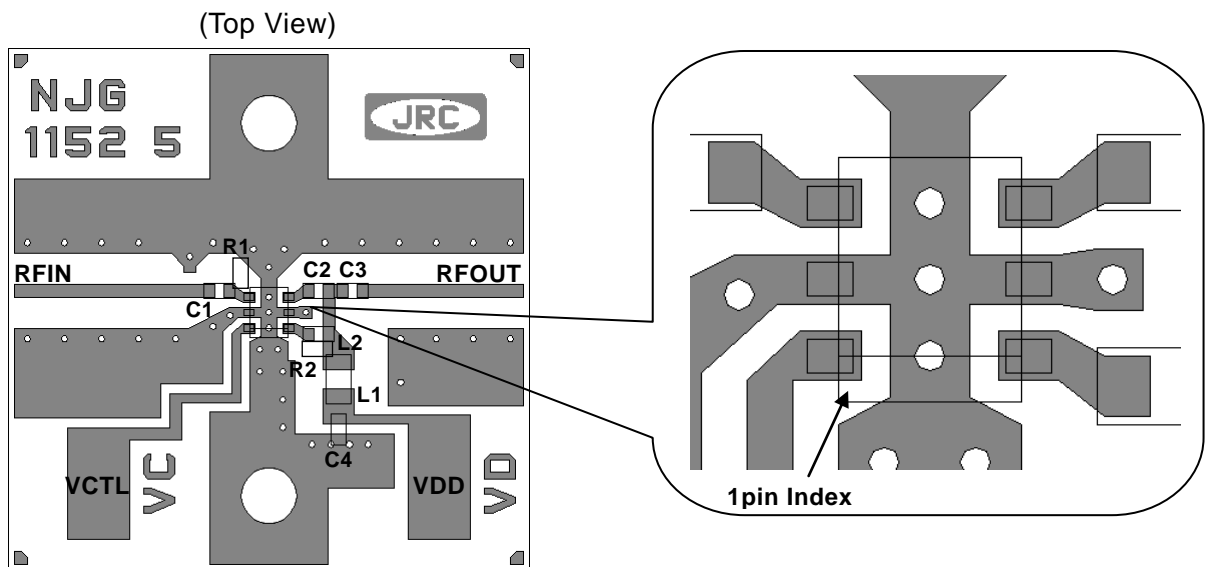

PCB: FR-4, $t=0.2\text{mm}$
 Microstrip line width: 0.4mm
 PCB size: 16.8mm x 16.8mm

Parts List

Parts ID	Manufacture
L1	TAIYO-YUDEN HK1608 Series
L2	TAIYO-YUDEN HK1005 Series
C1~C4	MURATA GRM15 Series
R1, R2	KOA RK73 Series

PRECAUTIONS

- C1 to C3 is DC-Blocking capacitors, and C4 is a bypass capacitor.
- L1 is RF choke inductor. (DC feed inductor)
- R1 is the resistance to adjust the operating current.
- R2 is the resistance for stability.
- L2 is the inductor to adjust the impedance matching.
- All external parts, please be placed as close to the IC.
- In order not to couple with terminal RFIN and RFOUT, please layout ground pattern under the IC.

■ MEASUREMENT BLOCK DIAGRAM

Measuring instruments

NF Analyzer : Agilent 8973A

Noise Source : Agilent 346A

Setting the NF analyzer

Measurement mode form

Device under test : Amplifier

System downconverter : off

Mode setup form

Sideband : LSB

Averages : 4

Average mode : Point

Bandwidth : 4MHz

Loss comp : off

Tcold : setting the temperature of noise source (303K)

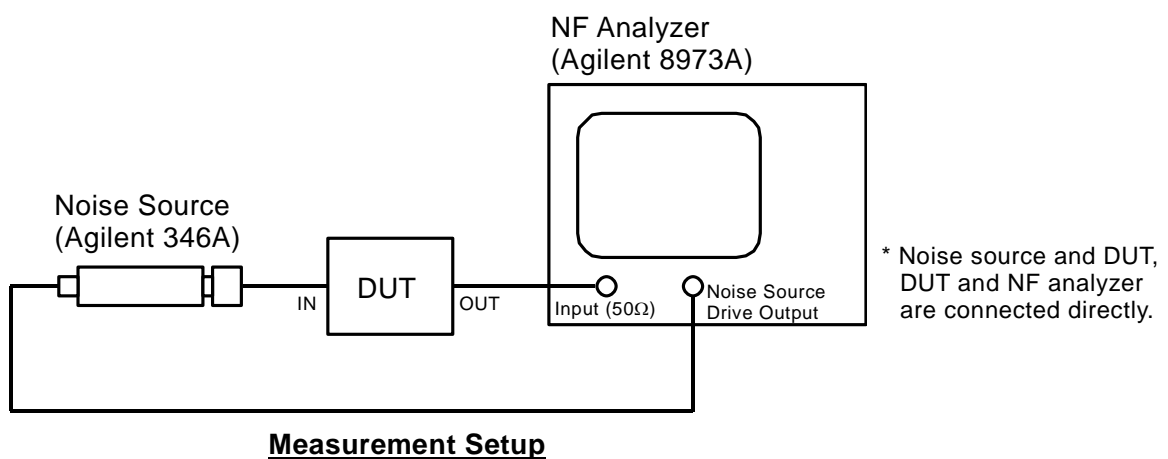
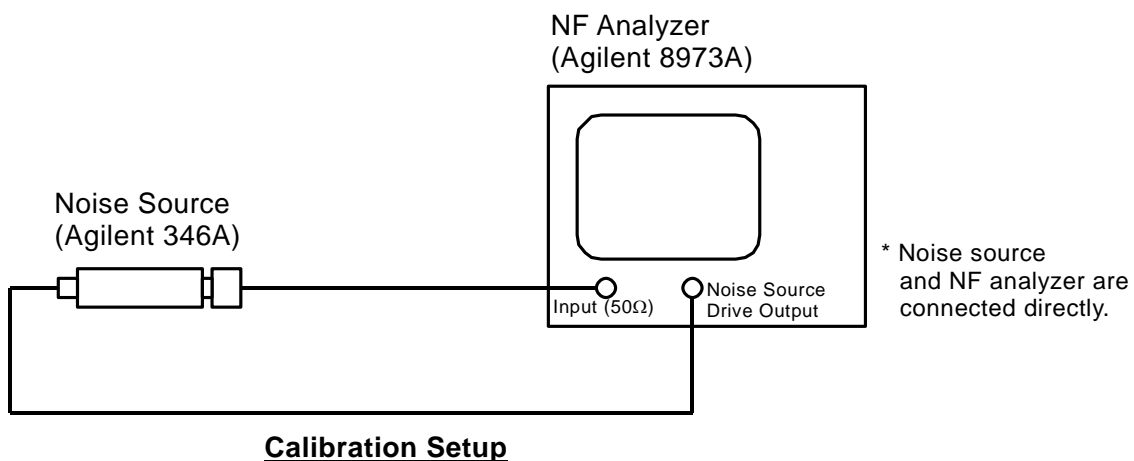

■ PACKAGE OUTLINE (FLP6-A1)

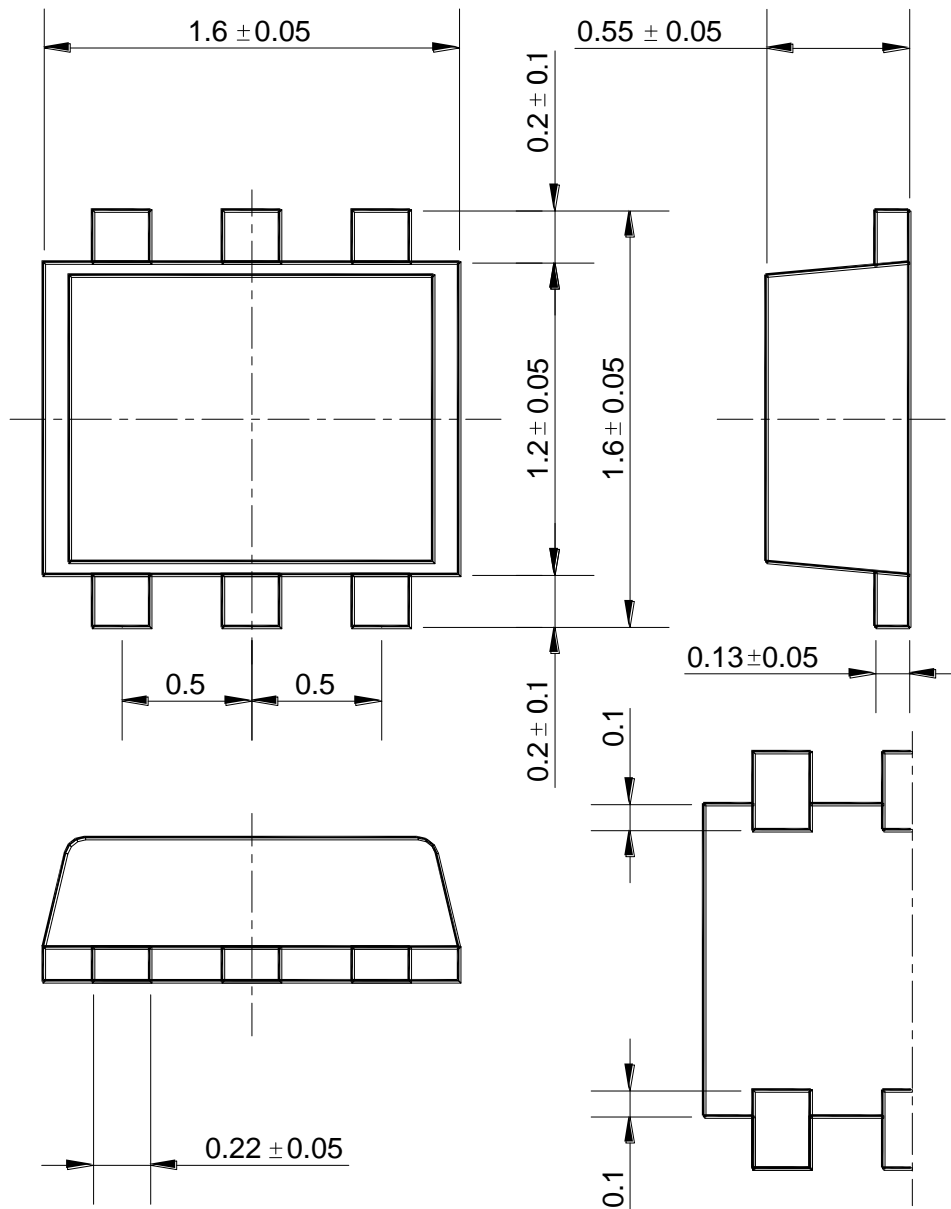

Unit : mm
 Leads Material : Copper
 Leads Finish : SnBi
 Molding Material : Epoxy Resin
 Weight : 3.1mg

Cautions on using this product

This product contains Gallium-Arsenide (GaAs) which is a harmful material.

- Do NOT eat or put into mouth.
- Do NOT dispose in fire or break up this product.
- Do NOT chemically make gas or powder with this product.
- To waste this product, please obey the relating law of your country.

[CAUTION]

The specifications on this databook are only given for information, without any guarantee as regards either mistakes or omissions. The application circuits in this databook are described only to show representative usages of the product and not intended for the guarantee or permission of any right including the industrial rights.

This product may be damaged with electric static discharge (ESD) or spike voltage. Please handle with care to avoid these damages.