

SMD3225 石英晶体谐振器
 30.000MHz/TOL: ±10ppm/CL:20PF

SPECIFICATION REQUIREMENTS FOR CRYSTAL

晶体产品要求

电气参数 **Electrical Characteristic:**

1. Model No.	SMD3225 (4pin)
2. Nominal Frequency(FN)	30.000MHz
3. Oscillation Mode	<input checked="" type="checkbox"/> Fundamental <input type="checkbox"/> 3RD overtone <input type="checkbox"/> 5th overtone
4. Frequency Tolerance (ΔF)	±10ppm (ref. at 25°C)
5. Operation Temperature	-20°C to +70°C
6. Storage Temperature	-40°C to +85°C
7. Frequency stability(Tol)	±20ppm
8. Load Capacitance(CL)	20PF
9. Series Resistance(ESR)	≤40 Ω
10. Drive Level	100uW
11. Shunt Capacitance (Co)	3.0PF
12. Aging Rate Per Year	±3ppm/year
13. Insulation Resistance	500MΩ min. at DC 100V±10V
14. Test Circuit.	Measured by S&A 250B

产品结构、尺寸

Mechanical Dimensions 外型尺寸

UNIT(单位) : mm (毫米)

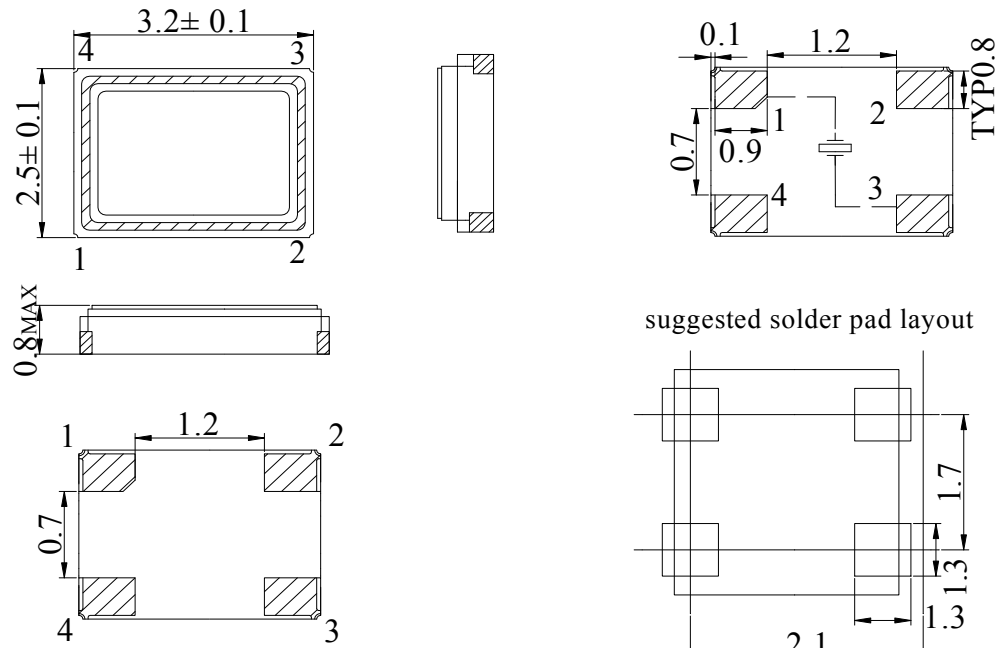

Note) #2,#4 is connected with a cover
(Please connect with a GND or a power supply)

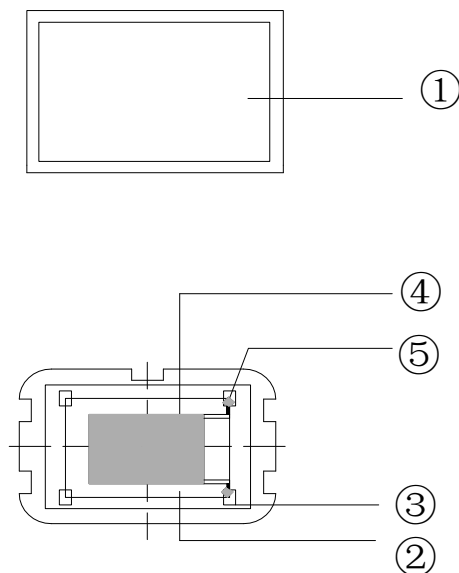

NO.	NAME	名称
①	CAN	外壳
②	BASE	基座
③	LEAD	焊点
④	BLANK	晶片
⑤	RESIN	导电胶

包装要求

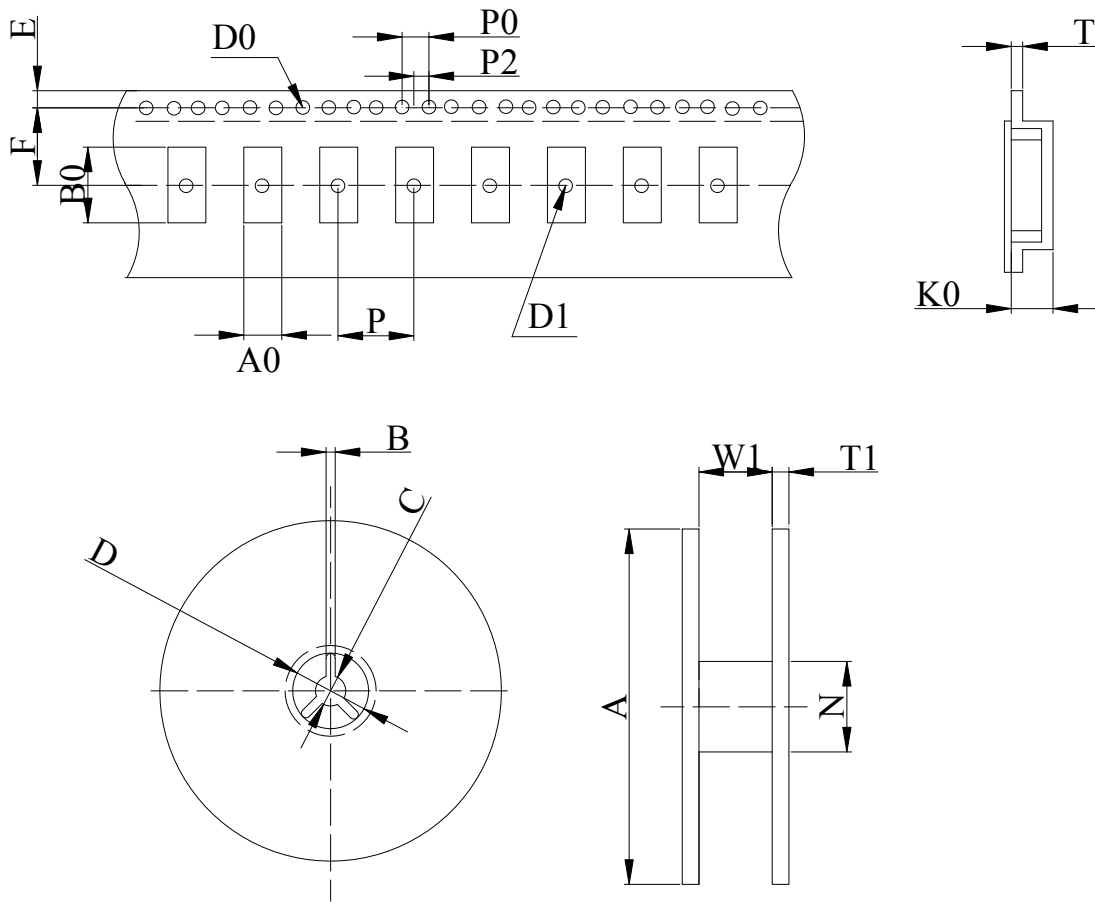

	NC-49SMD	8045	7050	6035	5032	4025	3225
W							12.00±0.05
E							1.75±0.10
F							5.5±0.10
T							0.30±0.05
P							8.00±0.10
P0							4.00±0.10
P2							2.00±0.10
D0							Φ1.50±0.10
D1							Φ1.50MIN
A0							2.85±0.10
K0							0.85±0.10
B0							3.55±0.10
A							Φ178±2.00
B							2.00±0.50
C							Φ13.2±0.20
D							Φ20±0.50
N							Φ60.5±1.00
W1							12.5±0.20
T1							1.80±0.20

可靠性实验规范

RELIABILITY SPECIFICATION

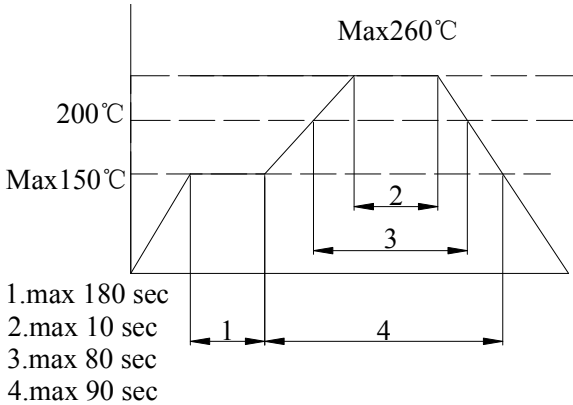
序号	RELIABILITY 试验名称	RELIABILITY CONDITIONS 可靠度试验条件	SPECIFICATION 规格说明
1	ELECTRODE TERMINAL PULL 电极端子拉力	1KG FORCE IN AXES OF ELECTRODE TERMINATION 10±1sec 1KG 力垂直施于电极端子上 10±1 秒	1.GLASS HERMETICITY & VISUAL. 玻璃密封性和外观检视 2. LEAD CRACKED or BROKEN NOT ALLOWED' 不允许引线断裂或破裂
2	ELECTRODE WIRE-LEAD BEND 电极端子弯曲拉力	2.5mm FROM ELECTRODE TERMINAL,BEND 90° , '0.45KG MASS APPLIED 3TIMES. 2.5 毫米处电极端子弯曲 90°	
3	SOLDERABILITY 产品可焊性	SOLDER:235 ± 5 °C ,DIPPING:5 ± 0.5sec. 焊接温度:235±5°C,浸渍时间:5±0.5 秒	AT LEAST 95% COATING. 至少覆盖率为 95%
4	RESISTANCE TO 产品可焊耐热时间	SOLDER:260+5 °C ,DIPPING:10 ± 1sec. 焊接温度:260±5°C,浸渍时间:10±1 秒 	1.AT LEAST 95% COATING 至少覆盖率为 95% 2. $\Delta F/F \leq \pm 5\text{ppm}$ $\Delta F/Rr \leq \pm 10\%$ or 2 Ω BETTER,20%
5	VIBRATION TEST 振动测试	10g,10 ~ 55 ~ 10hz 1MINUTE,X、Y、Z PLANE EACH 2hrs. 10G, 10~55~10 赫兹 1 分钟,X、Y、Z 水 平面,每 2 小时	$\Delta F/F \leq \pm 5\text{ppm}$ $\Delta F/Rr \leq \pm 10\%$ or 2 Ω BETTER,20%
6	DROP TEST 跌落测试	75CM HIGH,3 TIMES ON HARD BOARD 75 厘米高, 3 次坠落在硬木质板上	$F/F \leq \pm 5\text{ppm}$ $\Delta F/Rr \leq \pm 10\%$ or 2 Ω BETTER,20%
7	AGING TEST 老化测试	85°C Dynamic 1000hrs 85°C 动态测试 1000 小时	$F/F \leq \pm 5\text{ppm}$ $\Delta F/Rr \leq \pm 10\%$ or 2 Ω BETTER,20%
8	CCELERATED AGING 加速老化测试	125 °C ± 3 °C ,TIME:168 hrs. Dynamic 125°C±3°C,的动态下:168 小时.	$F/F \leq \pm 5\text{ppm}$ $\Delta F/Rr \leq \pm 10\%$ or 2 Ω BETTER,20%
9	SALT SPRAY 盐水喷雾试验	5%NaCL 35 °C ± 2 °C CHAMBER,48hrs.PH 值:6.5~7.2 5% NaCL(碳酸钠),35 °C ± 2 °C 的温箱里,48 小时 PH 值:6.5~7.2	1.NO CORROSION ON LEAD&CAN 1.基座和外壳无腐蚀 $F/F \leq \pm 5\text{ppm}$ $\Delta F/Rr \leq \pm 10\%$ or 2 Ω BETTER,20%

10	HIGH-LOW TEM. STORAGE(STATIC) 高低温储存(静态测试)	HIGH TEM:125°C ± 2°C,1000hrs 高温:125°C ± 2°C,1000 小时 LOW TEM:-40°C ± 3°C,1000hrs 低温:-40°C ± 3°C,1000 小时	F/F ≤ ± 5ppm △ F/Rr ≤ ± 10% or 2 Ω BETTER,20%
11	HIGH TEM. & HUM. STORAGE TEST 高温高湿储存试验	TEM:40°C ± 2°C HUM:83%-88%,96hrs 温度:40°C ± 2 湿度:83%-88% ,储存 96 小时	F/F ≤ ± 5ppm △ F/Rr ≤ ± 10% or 2 Ω BETTER,20%
12	TEM. & HUM. CYCLING TEST 温湿度循环测试	TEM:-10°C ± 2°C ~ 65°C ± 2°C 24hrs 1 cycle' HUM:93 ± 3% 5 cycles 温度:-10°C ± 2°C ~ 65°C ± 2°C,湿度:93 ± 3%, 24 小时为 1 循环, 运行 5 个循环	F/F ≤ ± 5ppm △ F/Rr ≤ ± 10% or 2 Ω BETTER,20%
13	HIGH-LOW TEM. OPERATING TEST 高-低温运行测试	HIGH TEM:85°C ± 2°C,2hrs 高温:85°C ± 2°C,运行 2 小时 LOW TEM:-30°C ± 2°C,2hrs 低温:-30°C ± 2°C 运行 2 小时	F/F ≤ ± 5ppm △ F/Rr ≤ ± 10% or 2 Ω BETTER,20%
14	FREQUENCY/Rr V.S OPERATING TEM.. 频率/电阻在操作温度下之变化测试	TEM:-10°C ~ +60°C、-20°C ~ +70°C、0°C ~ 70°C 'MEASURE POINT: EVERY 10°C DEVIATION. 温度:-10°C ~ +60°C、-20°C ~ +70°C 0°C ~ 70°C 测试点:依每 10°C 测试一值	AS SPECIFICATION 依客户要求
15	<p data-bbox="225 1149 507 1223">HIGH LOW SHOCK 高低温冲击</p> <div data-bbox="225 1088 1412 1590"> <p data-bbox="1106 1088 1412 1200">1. 150°C 60--120Sec Max 2. 200°C 20--30Sec Max 3. 260°C 10Sec Max</p> <p data-bbox="225 1256 389 1285">260°C MAX</p> <p data-bbox="225 1364 341 1393">150 ± 5</p> <p data-bbox="743 1525 845 1554">120 SEC</p> <p data-bbox="1027 1561 1117 1590">10 SEC</p> </div> <p data-bbox="225 1644 501 1677">SPECIFICATION</p> <p data-bbox="225 1704 745 1744">规格说明: $\Delta F/F \leq \pm 5\text{ppm}$</p> <p data-bbox="488 1787 1075 1825">$\Delta F/Rr \leq \pm 10\% \text{ or } 2 \Omega$ BETTER,20%</p>		