



MSL 1

5.0SMDJxx(C)A

## Power Transient Voltage Suppressor

## Features

- 5000 watts Peak Pulse Power (10/1000 $\mu$ s)
- Unidirectional and Bidirectional Protection
- Fast Response Time : Typically < 1ns
- Excellent Clamping Capability
- Built-in Strain relief
- Low inductance
- Low profile package
- High temperature solder:260 $^{\circ}$ C/10 seconds at terminal

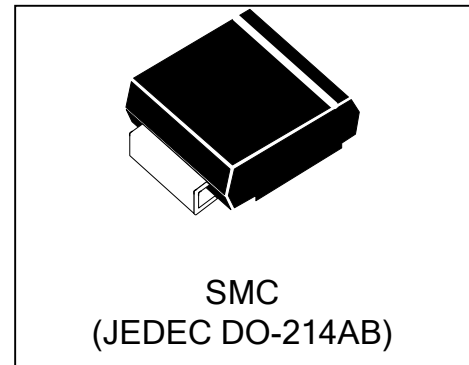

## Mechanical Characteristics

- JEDEC DO-214AB package
- Molding compound flammability rating: UL 94V-0
- Marking: Marking Code
- Packaging: Tape and Reel per EIA 481
- RoHS &UL497B Compliant

## Applications

- I/O Interfaces
- Power lines
- Automotive and Telecommunication
- Computers &Consumer Electronics
- Industrial Electronics

Absolute Maximum Rating			
Rating	Symbol	Value	Units
Peak Pulse Power ( $t_p = 10/1000\mu s$ ) (see Note1,2& 3)	P <sub>PPM</sub>	5000	Watts
Peak pulse current (10/1000 $\mu$ s) (see Note2&3)	I <sub>PPM</sub>	See Electrical Characteristics	A
Peak Forward surge current (see Note4&5)	I <sub>FSM</sub>	300	A
Power Dissipation on infinite heat sink T <sub>L</sub> = 50 $^{\circ}$ C (Fig5)	P <sub>D</sub>	6.5	W
Operating Junction Temperature range	T <sub>J</sub>	-65 to + 150	$^{\circ}$ C
Storage Temperature range	T <sub>STG</sub>	-65 to + 150	$^{\circ}$ C

**Note1:** Peak Pulse Power Rating as Pulse Width, per Fig1.

**Note2:** Peak Pulse Power or Current Derated above T<sub>A</sub>=25 $^{\circ}$ C Per Fig. 2 and Non-Repetitive Current Pulse, Per Fig.3.

**Note3:** Mounted on 5.0x5.0mm<sup>2</sup> copper pad to each terminal.

**Note4:** 8.3ms Single Half Sine Wave or Equivalent Square Wave.

**Note5:** Maximum Forward Surge Current only for Unidirectional Device per Fig6.

## Electrical Characteristics

Part Number		Reverse Stand off Voltage $V_{RWM}$ (Volts)	Breakdown Voltage		Test Current $I_T$ (mA)	Maximum Clamping Voltage $V_C@I_{PP}$ (Volts)	Maximum Peak Pulse Current $I_{PP}$ (Amps)	Maximum Reverse Leakage $I_R@V_{RWM}$ ( $\mu$ A)
			$V_{BR}(\text{Volts})@I_T$					
UNI-POLAR	BI-POLAR		MIN	MAX				
5.0SMDJ12A	5.0SMDJ12CA	12	13.3	14.7	10	19.9	252.0	800
5.0SMDJ13A	5.0SMDJ13CA	13	14.4	15.9	10	21.5	233.0	500
5.0SMDJ14A	5.0SMDJ14CA	14	15.6	17.2	10	23.2	216.0	200
5.0SMDJ15A	5.0SMDJ15CA	15	16.7	18.5	1	24.4	205.0	100
5.0SMDJ16A	5.0SMDJ16CA	16	17.8	19.7	1	26.0	193.0	50
5.0SMDJ17A	5.0SMDJ17CA	17	18.9	20.9	1	27.6	181.0	20
5.0SMDJ18A	5.0SMDJ18CA	18	20.0	22.1	1	29.2	172.0	10
5.0SMDJ20A	5.0SMDJ20CA	20	22.2	24.5	1	32.4	155.0	5
5.0SMDJ22A	5.0SMDJ22CA	22	24.4	26.9	1	35.5	141.0	5
5.0SMDJ24A	5.0SMDJ24CA	24	26.7	29.5	1	38.9	129.0	5
5.0SMDJ26A	5.0SMDJ26CA	26	28.9	31.9	1	42.1	119.0	5
5.0SMDJ28A	5.0SMDJ28CA	28	31.1	34.4	1	45.4	110.0	5
5.0SMDJ30A	5.0SMDJ30CA	30	33.3	36.8	1	48.4	103.0	5
5.0SMDJ33A	5.0SMDJ33CA	33	36.7	40.6	1	53.3	93.9	5
5.0SMDJ36A	5.0SMDJ36CA	36	40.0	44.2	1	58.1	86.1	5
5.0SMDJ40A	5.0SMDJ40CA	40	44.4	49.1	1	64.5	77.6	5
5.0SMDJ43A	5.0SMDJ43CA	43	47.8	52.8	1	69.4	72.1	5
5.0SMDJ45A	5.0SMDJ45CA	45	50.0	55.3	1	72.7	68.8	5
5.0SMDJ48A	5.0SMDJ48CA	48	53.3	58.9	1	77.4	64.7	5
5.0SMDJ51A	5.0SMDJ51CA	51	56.7	62.7	1	82.4	60.7	5
5.0SMDJ54A	5.0SMDJ54CA	54	60.0	66.3	1	87.1	57.5	5
5.0SMDJ58A	5.0SMDJ58CA	58	64.4	71.2	1	93.6	53.5	5
5.0SMDJ60A	5.0SMDJ60CA	60	66.7	73.7	1	96.8	51.7	5
5.0SMDJ64A	5.0SMDJ64CA	64	71.1	78.6	1	103.0	48.6	5
5.0SMDJ70A	5.0SMDJ70CA	70	77.8	86.0	1	113.0	44.3	5
5.0SMDJ75A	5.0SMDJ75CA	75	83.3	92.1	1	121.0	41.4	5
5.0SMDJ78A	5.0SMDJ78CA	78	86.7	95.8	1	126.0	39.7	5
5.0SMDJ85A	5.0SMDJ85CA	85	94.4	104.0	1	137.0	36.5	5
5.0SMDJ90A	5.0SMDJ90CA	90	100.0	111.0	1	146.0	34.3	5
5.0SMDJ100A	5.0SMDJ100CA	100	111.0	123.0	1	162.0	30.9	5
5.0SMDJ110A	5.0SMDJ110CA	110	122.0	135.0	1	177.0	28.3	5
5.0SMDJ120A	5.0SMDJ120CA	120	133.0	147.0	1	193.0	26.0	5
5.0SMDJ130A	5.0SMDJ130CA	130	144.0	159.0	1	209.0	24.0	5
5.0SMDJ150A	5.0SMDJ150CA	150	167.0	185.0	1	243.0	20.6	5
5.0SMDJ160A	5.0SMDJ160CA	160	178.0	197.0	1	259.0	19.3	5
5.0SMDJ170A	5.0SMDJ170CA	170	189.0	209.0	1	275.0	18.2	5

Typical Characteristics

Figure 1: Peak Pulse Power Rating Curve

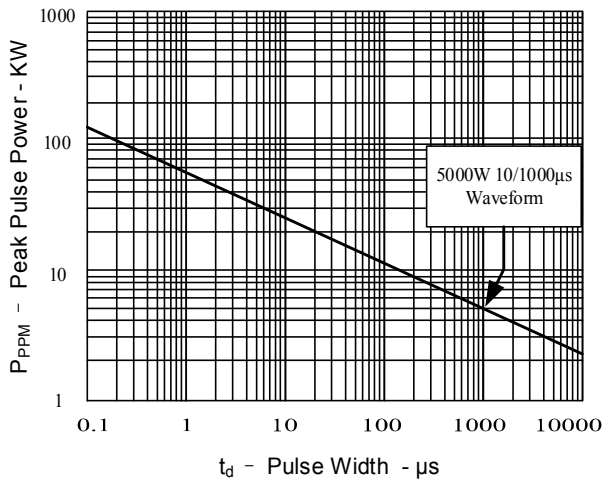

Figure 2: Pulse Derating Curve

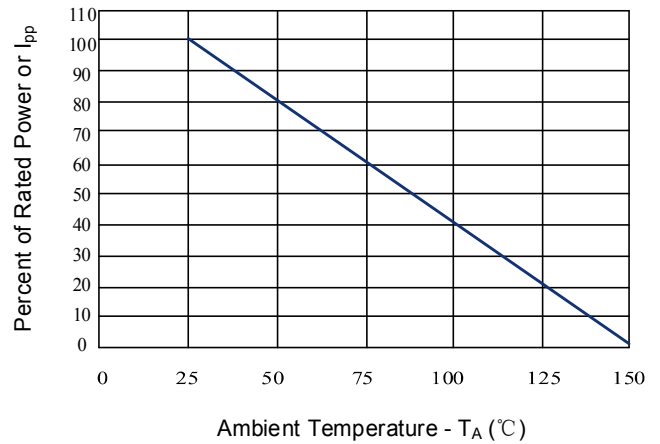

Figure 3: Pulse Waveform

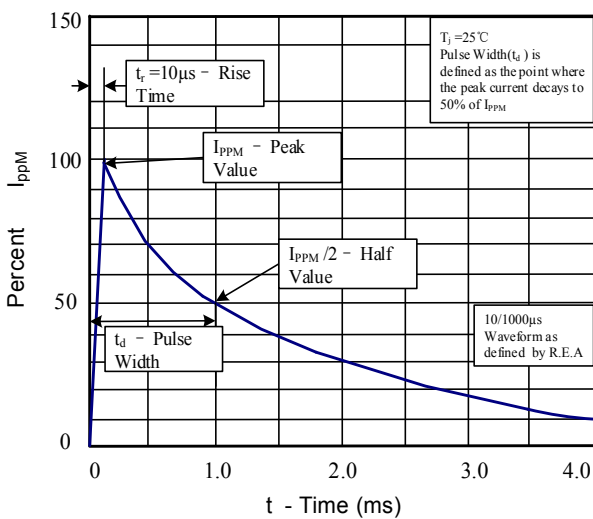

Figure 4: Typical Junction Capacitance

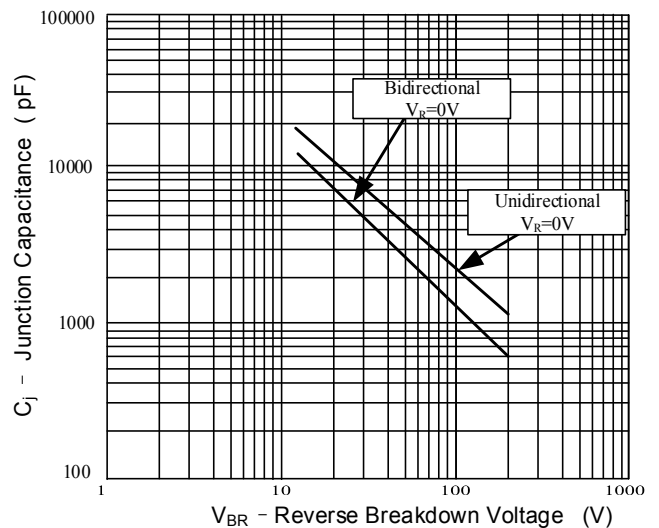

Figure 5: Steady State Power Dissipation Derating Curve

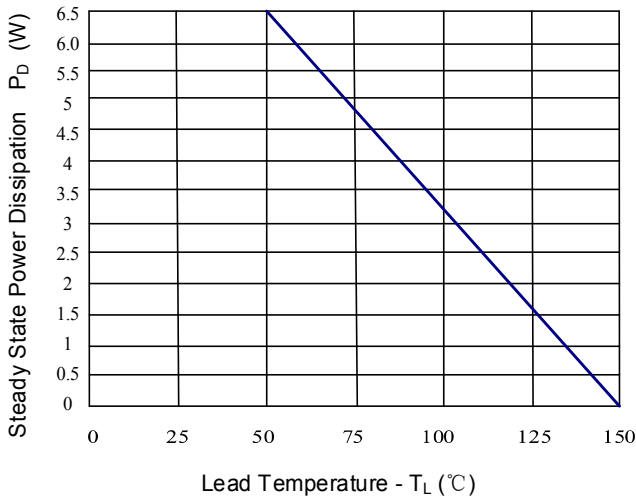
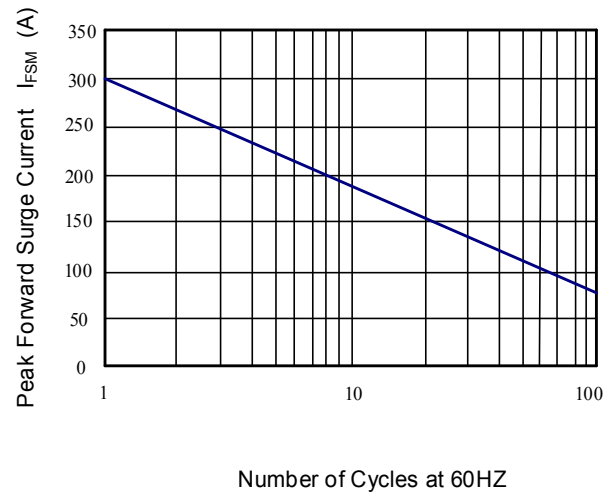
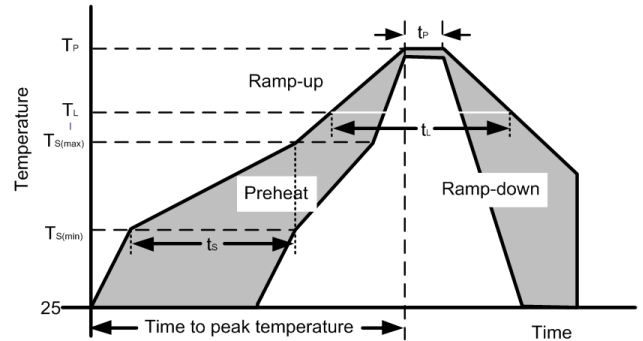

Figure 6: Maximum Non-Repetitive Forward Surge Current Only Unidirectional



Recommended Soldering Parameters

Reflow Condition		
Pre-Heat	Temperature min ( $T_{s(min)}$ )	150°C
	Temperature max ( $T_{s(max)}$ )	200°C
	Time (min to max) ( $t_s$ )	60-190 s
Average ramp up rate (Liquidus Temp) ( $T_L$ ) to peak		3°C/s max
Ts(max) to TL - Ramp-up Rate		3°C/s max
Reflow	Temperature ( $T_L$ ) (Liquidus)	217°C
	Temperature ( $t_L$ )	60-150 s
Peak Temperature ( $T_P$ )		260 <sup>+0/-5</sup> °C
Time within actual peak Temperature ( $t_p$ )		20-40 s
Ramp-down Rate		5°C/s max
Time 25°C to peak Temperature ( $T_P$ )		8 minutes max
Do not exceed		260°C



Outline Drawing – SMC(DO-214AB)

Ref. (mm)	Millimeters	
	Min.	Max.
A	2.06	2.70
A1	-	0.30
B	2.90	3.20
E	6.60	7.40
E1	7.75	8.13
D	5.59	6.22
L	0.76	1.52

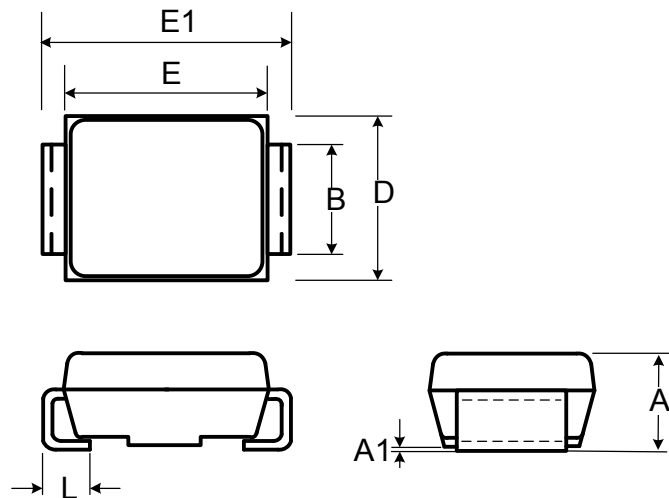

Recommended Solder Pad Layout

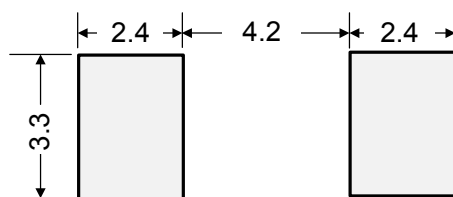

Dimensions in mm

Part Numbering System

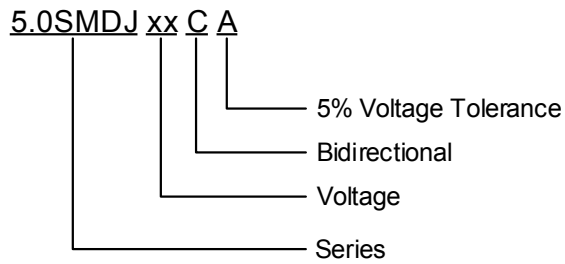

Part Marking System

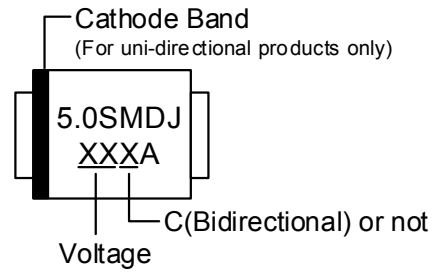

Package Information

Package Type	Description	Quantity ( pcs )	Standard
SMC(DO-214AB)	Tape & Reel -16mm/13" tape	3000	EIA-481-D

Contact Information

No.1001, Shiwan(7) Road, Pudong District, Shanghai, P.R.China.201207

Tel: +86-21-68969993 Fax: 86-21-50757680 Email: market@way-on.com

WAYON website: <http://www.way-on.com>

For additional information, please contact your local Sales Representative.

**WAYON**® is registered trademarks of Wayon Corporation.

*Specifications are subject to change without notice.  
The device characteristics and parameters in this data sheet can and do vary in different applications and actual device performance may vary over time.  
Users should verify actual device performance in their specific applications.*