

1.2MHz, 30V Output, Step-Up WLED Driver

Features

- 2.5V to 5.5V Input Voltage
- Drivers up to 8 Series WLEDs
- Low 250mV Feedback Voltage
- 1.2MHz Fixed Switching Frequency
- Internal 1.6A Switch Current Limit
- Internal Compensation
- Thermal Shutdown
- Over Voltage Protection
- Dimming with wide Frequency Range
- Available in a 6-pin SOT-23 package

Applications

- Camera Flash White LED
- Digital still cameras
- PDA LED back light

General Description

The Y3730 is a step-up converter designed for driving up to 8 Series white LED's from a single cell Lithium Ion battery. Its low 250mV feedback voltage reduces power loss and improves efficiency.

Optimized operation frequency can meet the requirement of small LC filters value and low operation current with high efficiency. Internal soft start function can reduce the inrush current. Tiny package type provides the best solution for PCB space saving and total BOM cost.

Typical Application Circuit

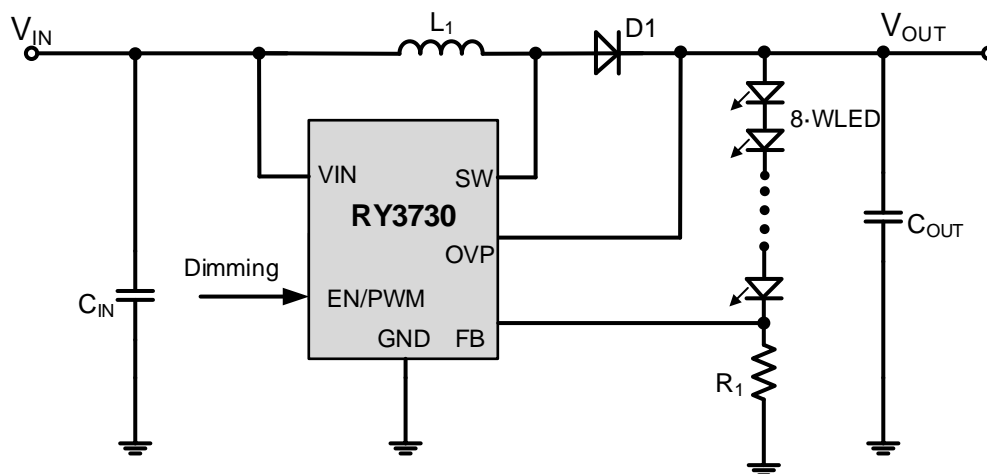
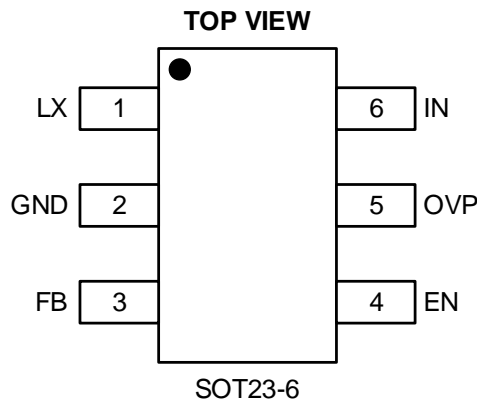

Figure1. Basic Application Circuit

1.2MHz, 30V Output, Step-Up WLED Driver

Package and Pin Description



Top Marking: KDYLL (device code: KD, Y=year code, LL= lot number code)

Pin	Name	Function
1	LX	Power Switch Output. LX is the drain of the internal MOSFET switch. Connect the power inductor and output rectifier to LX. LX can swing between GND and 30V.
2	GND	Ground Pin
3	FB	Feedback Input. The FB voltage is 0.25V. Connect a resistor divider to FB.
4	EN	Regulator On/Off Control Input. A high input at EN turns on the converter, and a low input turns it off. When not used, connect EN to the input supply for automatic startup.
5	OVP	Over Voltage Input. OV measures the output voltage for open circuit protection. Connect OV to the output at the top of the LED string.
6	IN	Input Supply Pin. Must be locally bypassed.

Order Information

Marking	Part No.	Model	Description	Package	MOQ
<u>KDYLL</u>	70390004	RY3730	RY3730 WLED Driver, 2.5-5.5V, 8 Series WLED Driver, 1.2MHz, SOT23-6	SOT23-6	3000PCS

1.2MHz, 30V Output, Step-Up WLED Driver

Absolute Maximum Ratings

Parameter	Absolute Maximum Ratings	Unit
V_{IN}, V_{EN}	-0.3 to 6	V
V_{SW}	-0.3 to 30	V
All Other Pins	-0.3 to 6	V
Continuous Power Dissipation($T_A=+25^{\circ}C$)	0.6	W
Junction Temperature	150	$^{\circ}C$
Operating Temperature Range	-40 to 85	
Lead Temperature	260	$^{\circ}C$
Storage Temperature	-65 to 150	$^{\circ}C$
Thermal Resistance θ_{JA}	250	$^{\circ}C/W$
Thermal Resistance θ_{JC}	130	$^{\circ}C/W$

Recommended Operating Conditions

Parameter	Recommended	Unit
Supply Voltage V_{IN}	2.5 to 5.5	V
Output Voltage V_{OUT}	V_{IN} to 30	V
Operating Junction Temp.(T_J)	-40 to 125	$^{\circ}C$

Electrical Characteristics

Parameter	Symbol	Test Conditions	Min	Typ	Max	Unit
Supply Current(Shutdown)	I_{IN}	$V_{EN}=0V$		0.1	1	μA
Quiescent Current		$V_{FB}=0.2V, switch$		0.15	0.3	mA
SW Leakage		$V_{SW} = 20V$			1	μA
SW On Resistance				400	650	m Ω
Operating Input Voltage			2.5		5.5	V
Current Limit	I_{LIMIT}	$V_{IN}= 4V, Duty\ cycle=50\%$		1.6		A
Oscillator Frequency	f_{SW}			1.2		MHz
Maximum Duty Cycle	D_{MAX}			90		%
Feedback Voltage	V_{FB}		237	250	263	mV
FB Input Bias Current			-50	-10		nA
EN Threshold	V_{EN}			1		V
OVP Threshold	V_{ovp}	OVP Threshold		35		V
Thermal Shutdown				160		$^{\circ}C$

1.2MHz, 30V Output, Step-Up WLED Driver

Typical Performance Characteristics

Note (1): Performance waveforms are tested on the evaluation board.

Note (2): VIN = 5V, 5 WLEDs, unless otherwise noted.

Efficiency vs Input Voltage

VIN = 5V

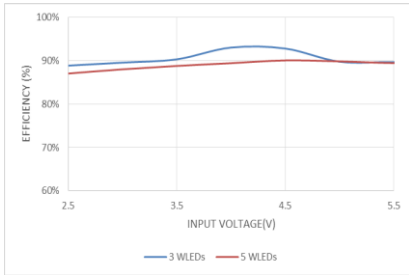

Steady State Operation

VIN = 5V, 5 WLEDs

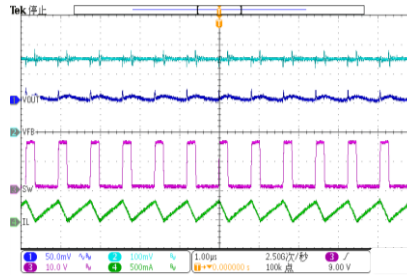

Enable Startup

VIN = 5V, 5 WLEDs

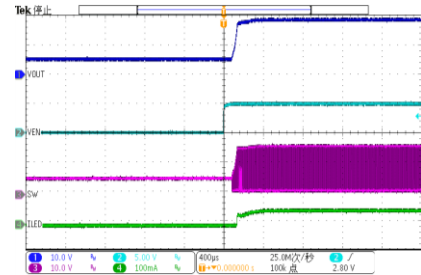

Enable Shutdown

VIN = 5V, 5 WLEDs

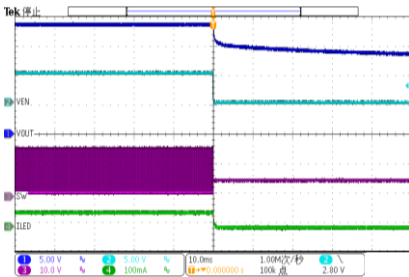

Start Up into Open Load

VIN = 5V

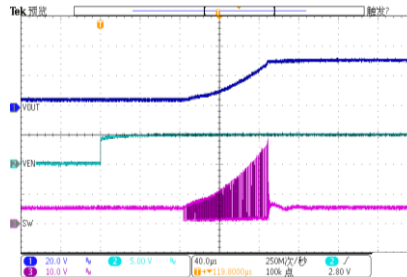

PWM Dimming

VIN = 5V, 5 WLEDs, f=200HZ

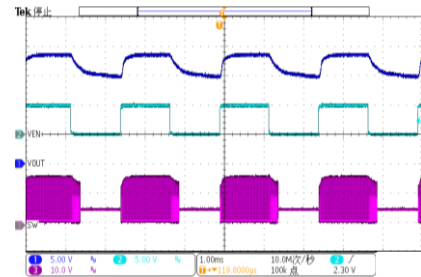

Output Current vs PWM Dimming Duty

f=200HZ

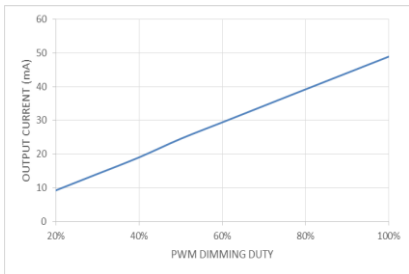

1.2MHz, 30V Output, Step-Up WLED Driver

Application information

Setting the LED Current

The LED current is controlled by the feedback resistor, R1, in Table 1. The current through the LEDs is given by the equation $250\text{mV}/R1$. Table 1 shows the selection of resistors for a given LED current.

I_{LED} (mA)	R1 (Ω)
1	250
5	50
10	25
15	16.7
20	12.5

Table 1— I_{LED} vs. R1

$$R1 = 0.25 / I_{LED}$$

I_{LED} is average LED current.

Dimming Control

a. Using a PWM Signal to EN Pin

For controlling the LED brightness, the RY3730 can perform the dimming control by applying a PWM signal to EN pin. The internal soft start and the wide range dimming frequency can eliminate inrush current and audio noise when dimming. The average LED current is proportional to the PWM signal duty cycle. The magnitude of the PWM signal should be higher than the maximum enable voltage of EN pin, in order to let the dimming control perform correctly for preventing the flicker issue, the requested PWM frequency is $\geq 1\text{kHz}$ or $\leq 200\text{Hz}$.

b. Using a DC Voltage

Using a variable DC voltage to adjust the brightness is a popular method in some applications. According to the Superposition Theorem, as the DC voltage increases, the voltage contributed to VFB increases and the voltage drop on R2 decreases, i.e. the LED current decreases. For example, if the VDC range is from 0V to 2.8V, the selection of resistors sets dimming control of LED current from 20mA to 0mA.

c. Using a Filtered PWM signal

Another common application is using a filtered PWM signal as an adjustable DC voltage for LED dimming control. A filtered PWM signal acts as the DC voltage to regulate the output current. In this circuit, the output ripple depends on the frequency of PWM signal. For smaller output voltage ripple ($< 100\text{mV}$), the recommended frequency of 2.8V PWM signal should be above 2kHz. To fix the frequency of PWM signal and change the duty cycle of PWM signal can get different output current.

1.2MHz, 30V Output, Step-Up WLED Driver

Inductor Selection

The recommended value of inductor is 4.7 to 22 μ H. Small size and better efficiency are the major concerns for portable device, such as RY3730 used for mobile phone. The inductor should have low core loss at 1.0MHz and low DCR for better efficiency. To avoid inductor saturation current rating should be considered.

Capacitor Selection

Input and output ceramic capacitors of 1 μ F are recommended for RY3730 applications. For better voltage filtering, ceramic capacitors with low ESR are recommended. X5R and X7R types are suitable because of their wider voltage and temperature ranges.

Diode Selection

Schottky diode is a good choice for RY3730 because of its low forward voltage drop and fast reverse recovery. Using Schottky diode can get better efficiency. The high speed rectification is also a good characteristic of Schottky diode for high switching frequency. Current rating of the diode must meet the root mean square of the peak current and output average current multiplication as following:

$$I_D(\text{RMS}) \approx \sqrt{(I_{\text{OUT}} \times I_{\text{PEAK}})}$$

The diode's reverse breakdown voltage should be larger than the output voltage.

Layout Consideration

For best performance of the RY3730, the following guide lines must be strictly followed.

- 1、 Input and Output capacitors should be placed close to the IC and connected to ground plane to reduce noise coupling.
- 2、 The GND and Exposed Pad should be connected to a strong ground plane for heat sinking and noise protection.
- 3、 Keep the main current traces as possible as short and wide.
- 4、 LX node of DC-DC converter is with high frequency voltage swing. It should be kept at a small area.
- 5、 Place the feedback components as close as possible to the IC and keep away from the noisy devices.

1.2MHz, 30V Output, Step-Up WLED Driver

Package Description

SOT23-6

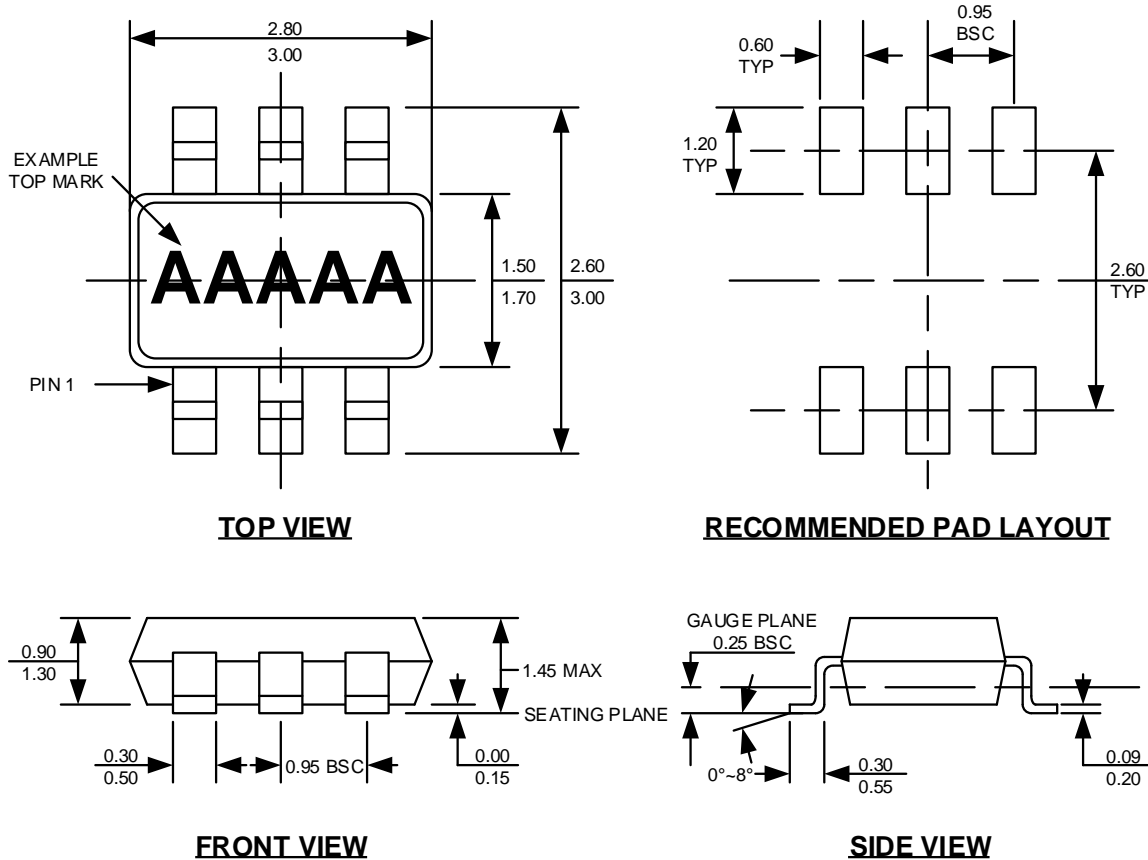

Note:

1. All dimensions are in millimeters.
2. Package length does not include mold flash, protrusion or gate burr.
3. Package width does not include flash or protrusion.
4. Lead coplanarity (bottom of leads after forming) shall be 0.10 millimeters max.
5. Pin 1 is lower left pin when reading top mark from left to right.