

### Sidelooker Phototransistor PT928-6C(X3-X5)(XBY)

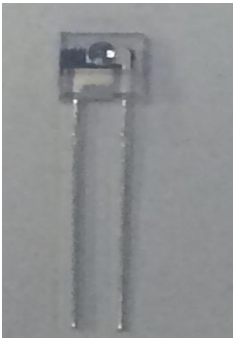

#### Features

- Fast response time
- High sensitivity
- Small junction capacitance
- Pb Free
- This product itself will remain within RoHS compliant version

#### Descriptions

- PT928-6C(X3-X5)(XBY) is a phototransistor in miniature package which is molded in a black plastic with spherical top view lens
- The device is spectrally matched to infrared emitting diode

#### Applications

- Optoelectronic switch
- VCR, Video Camera
- Floppy disk drive
- Infrared applied system

#### Device Selection Guide

Part Category	Chip Material	Lens Color
PT	Silicon	Water Clear

Package Dimension

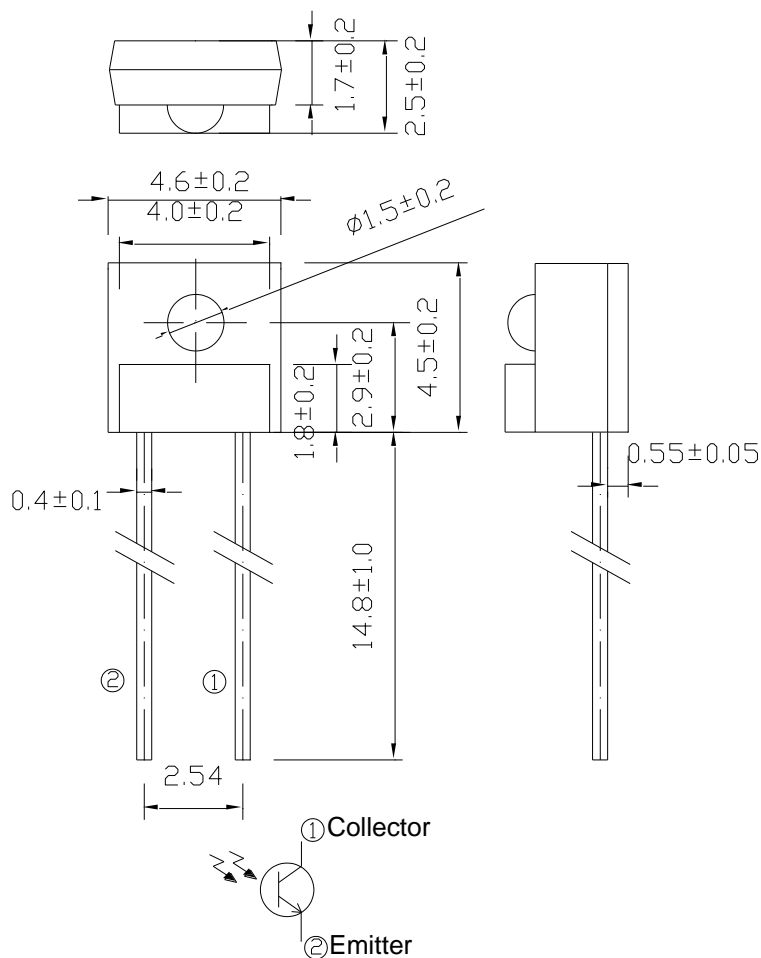

Notes: 1. All dimensions are in millimeters  
 2. Tolerances unless dimensions  $\pm 0.3\text{mm}$

Absolute Maximum Ratings ( $T_a=25^\circ\text{C}$ )

Parameter	Symbol	Rating	Units
Collector-Emitter Voltage	$V_{CEO}$	30	V
Emitter-Collector Voltage	$V_{ECO}$	5	V
Collector Current	$I_C$	20	mA
Operating Temperature	$T_{opr}$	-25 ~ +85	$^\circ\text{C}$
Storage Temperature	$T_{stg}$	-40 ~ +85	$^\circ\text{C}$
Soldering Temperature *1	$T_{sol}$	260	$^\circ\text{C}$
Power Dissipation at (or below) 25 $^\circ\text{C}$ Free Air Temperature	$P_d$	75	mW

Notes: \*1. Soldering time  $\leq 5$  seconds.

### Electro-Optical Characteristics (Ta=25°C)

Parameter	Symbol	Condition	Min.	Typ.	Max.	Units
Rang of Spectral Bandwidth	$\lambda_{0.5}$	----	450	--	1100	nm
Wavelength of Peak Sensitivity	$\lambda_p$	----	--	940	--	nm
Collector-Emitter Breakdown Voltage	$BV_{CEO}$	$I_C=100\mu A$ $E_e=0mW/cm^2$	30	--	--	V
Emitter-Collector Breakdown Voltage	$BV_{ECO}$	$I_E=100\mu A$ $E_e=0mW/cm^2$	5	--	--	V
Collector Dark Current	$I_{CEO}$	$V_{CE}=20V$ $E_e=0mW/cm^2$	--	--	100	nA
Collector-Emitter Saturation Voltage	$V_{CE(sat)}$	$I_C=2mA$ $E_e=1mW/cm^2$	--	--	0.4	V
On State Collector Current	$I_{C(on)}$	$V_{CE}=5V$ $E_e=0.555mW/cm^2$	2.0	--	3.91	$\mu A$

### Rank

Condition:  $I_F=4mA$ ,  $V_{CE}=3.5V$

Symbol	Condition	Ranks	Min.	Max.	Unit
$I_{C(ON)}$	$I_F=4mA$ $V_{CE}=3.5V$	X3	2.0	2.94	$\mu A$
		X4	2.40	3.41	
		X5	2.79	3.91	

**Notes:** This bin table is only for reference, not for specific bin shipment.

### Test Method For $I_{C(ON)}$ :

Condition:  $V_{CE}=5V$   $E_e=0.555mW/cm^2$

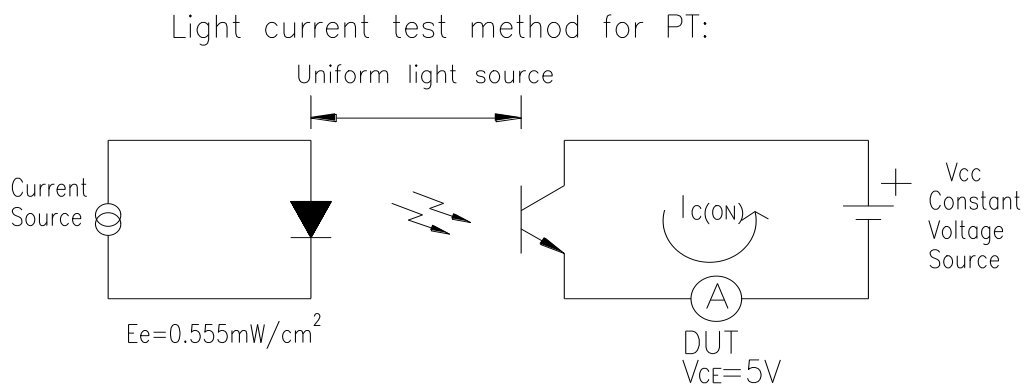

**Typical Electro-Optical Characteristics Curves**

Fig.1 Spectral Sensitivity

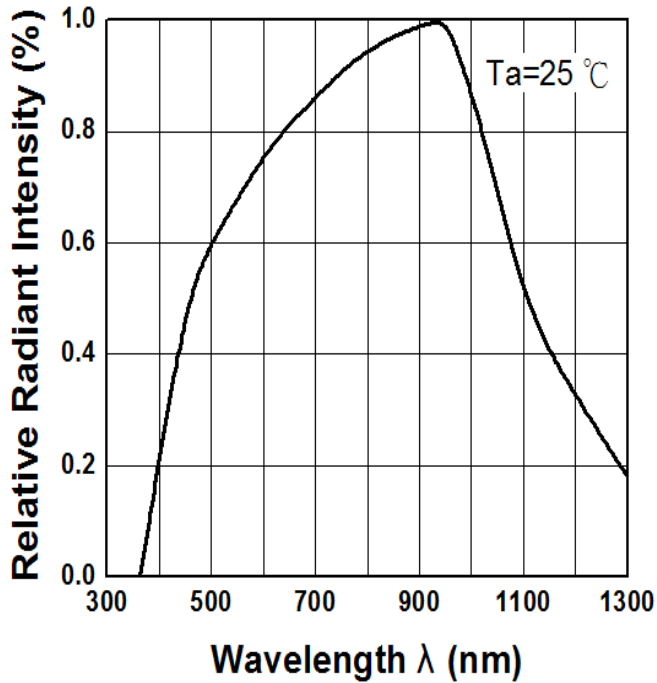

Fig.2 Collector Current vs Irradiance

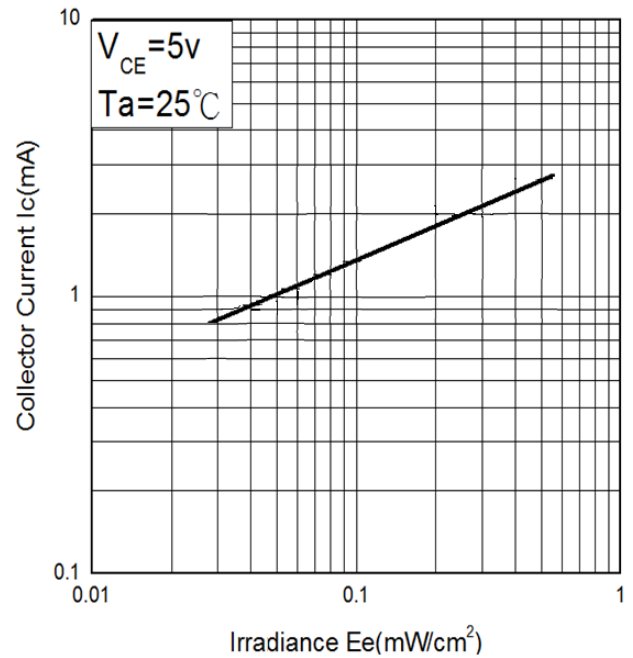
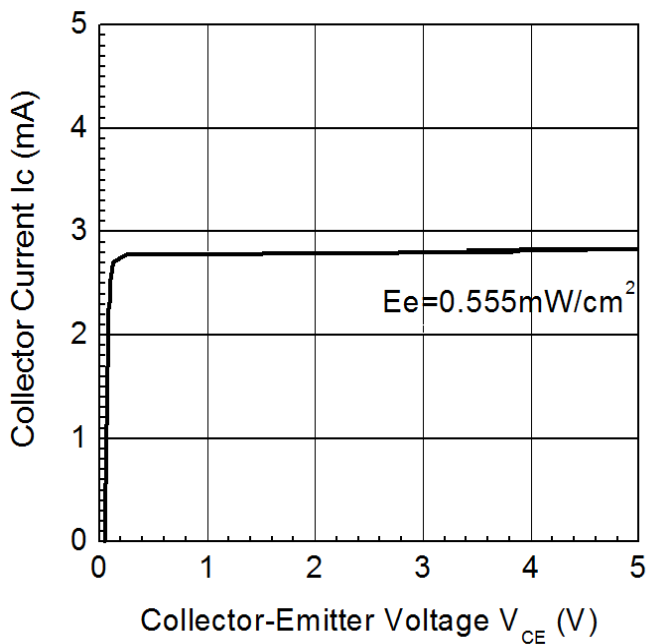

Fig.3 Collector Current vs. Collector-Emitter Voltage



### Packing Quantity Specification

1000 pcs/bag, 8 bags/box  
10 boxes/carton

### Label Form Specification

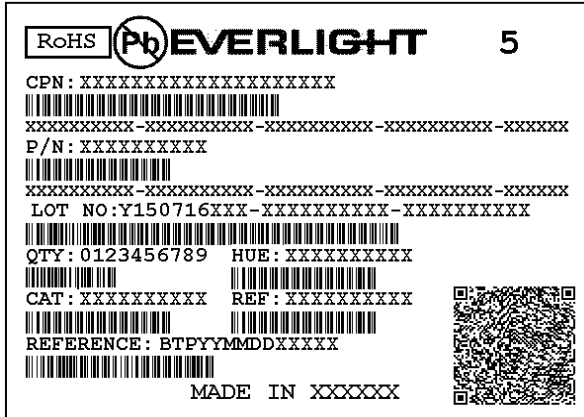

- CPN: Customer Part Number
- P/N: Part Number
- QTY: Packing Quantity
- CAT: Ranks
- HUE: Peak Wavelength
- REF: Reference
- LOT No: Lot Number

### Application Restrictions

1. Above specification may be changed without notice. EVERLIGHT will reserve authority on material change for above specification.
2. The graphs shown in this datasheet are representing typical data only and do not show guaranteed values.
3. When using this product, please observe the absolute maximum ratings and the instructions for use outlined in these specification sheets. EVERLIGHT assumes no responsibility for any damage resulting from use of the product which does not comply with the absolute maximum ratings and the instructions included in these specification sheets.
4. These specification sheets include materials protected under copyright of EVERLIGHT. Reproduction in any form is prohibited without the specific consent of EVERLIGHT.
5. This product is not intended to be used for military, aircraft, automotive, medical, life sustaining or life saving applications or any other application which can result in human injury or death. Please contact authorized Everlight sales agent for special application request.