



Nov. 2018 Ver.1.4a
TDK Corporation

Multilayer Triplexer

For LB-MB-HB / 5G-L / 5G-H

TPX Series 2.5x2.0mm [EIA 1008] TYPE

P/N: **TPX255000MT-7066A1**

PRELIMINARYNov. 2018 Ver.1.4a
TDK Corporation**TPX255000MT-7066A1****■ SHAPES AND DIMENSIONS**

[Top View]

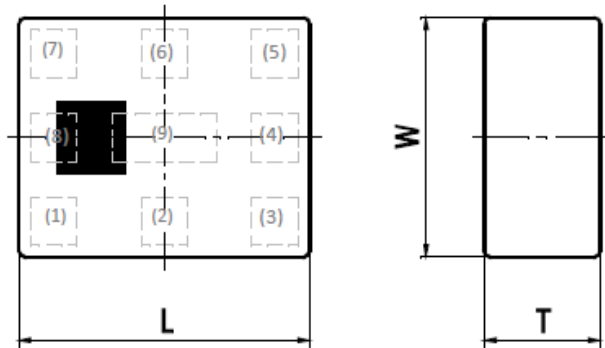

[Bottom View]

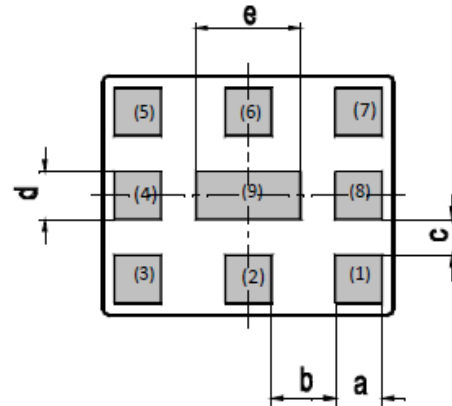

Dimensions (mm)

L	W	T	a	b	c	d	e
2.50	2.00	0.65	0.40	0.55	0.30	0.40	0.90
+/-0.15	+/-0.15	Max	+/-0.10	+/-0.10	+/-0.10	+/-0.10	+/-0.15

Terminal functions

(1)	Common Port
(2)	GND
(3)	5G-H
(4)	GND
(5)	5G-L

(6)	GND
(7)	MB-HB
(8)	GND
(9)	GND

■ TERMINATION FINISH

Material
Ag

All specifications are subject to change without notice.

TDK Technology - Proprietary and Confidential Information of TDK Group Companies

PRELIMINARYNov. 2018 Ver.1.4a
TDK Corporation**TPX255000MT-7066A1****ELECTRICAL CHARACTERISTICS**

(Measurement)

Low-Band

Parameter	Frequency (MHz)	TDK Spec		
		Min.	Typ.	Max.
Insertion Loss (dB)	617 to 960	-	0.32	0.50
	1166 to 1606	-	0.39	0.55
	1710 to 1785	-	0.36	0.50
	1805 to 1885	-	0.34	0.50
	1930 to 1990	-	0.32	0.50
	2300 to 2496	-	0.48	0.70
	2496 to 2690	-	0.81	1.20
Insertion Loss (dB) (-40 to +90 °C)	617 to 960	-	-	0.60
	1166 to 1606	-	-	0.65
	1710 to 1785	-	-	0.60
	1805 to 1885	-	-	0.60
	1930 to 1990	-	-	0.60
	2300 to 2496	-	-	0.82
	2496 to 2690	-	-	1.45
Return Loss (dB) (Low-Band Port)	617 to 2690	10	13.4	-
Attenuation (dB)	3300 to 3700	22	27.4	-
	3700 to 3800	22	27.2	-
	3800 to 4200	22	26.6	-
	4400 to 5000	27	30.0	-
	5150 to 5925	30	34.7	-
	5925 to 12750	10	31.9	-
Characteristic Impedance (ohm)		50 (Nominal)		

Ta = +25+/-5°C

Middle-Band

Parameter	Frequency (MHz)	TDK Spec		
		Min.	Typ.	Max.
Insertion Loss (dB)	3300 to 3400	-	0.92	1.20
	3400 to 3600	-	0.84	1.10
	3600 to 3800	-	1.07	1.35
Insertion Loss (dB) (-40 to +90 °C)	3300 to 3400	-	-	1.35
	3400 to 3600	-	-	1.30
	3600 to 3800	-	-	1.65
Return Loss (dB) (Middle-Band Port)	3300 to 3800	10	25	-
Attenuation (dB)	617 to 1427	22	23.7	-
	1427 to 2500	23	25.0	-
	2500 to 2690	19	23.9	-
	4400 to 5000	10	12.7	-
Characteristic Impedance (ohm)		50 (Nominal)		

Ta = +25+/-5°C

All specifications are subject to change without notice.

TDK Technology - Proprietary and Confidential Information of TDK Group Companies

PRELIMINARYNov. 2018 Ver.1.4a
TDK Corporation**TPX255000MT-7066A1****■ ELECTRICAL CHARACTERISTICS**

(Measurement)

High-Band

Parameter	Frequency (MHz)	TDK Spec		
		Min.	Typ.	Max.
Insertion Loss (dB)	4400 to 4800	-	0.98	1.40
	4800 to 5000	-	0.78	1.00
Insertion Loss (dB) (-40 to +90 °C)	4400 to 4800	-	-	1.61
	4800 to 5000	-	-	1.20
Return Loss (dB) (High-Band Port)	4400 to 5000	10	16.7	-
Attenuation (dB)	617 to 2690	25	36.3	-
	2170 to 3150	5	15.6	-
	3300 to 3600	14	16.7	-
	3600 to 3800	13	15.9	-
	3800 to 4200	1	2.8	-
	8800 to 10000	15	17.9	-
	13200 to 15000	7	12.5	-
Characteristic Impedance (ohm)		50 (Nominal)		

Ta = +25+/-5°C

Common

Parameter	Frequency (MHz)	TDK Spec		
		Min.	Typ.	Max.
Isolation (dB)				
Middle to Low (5G-L to MB-HB)	617 to 960	22	23.7	-
	1695 to 1710	25	36.9	-
	1710 to 2200	23	26.7	-
	2300 to 2690	19	25.6	-
	3300 to 3800	22	28.4	-
	5150 to 5925	30	46.2	-
High to Low (5G-H to MB-HB)	617 to 960	25	43.2	-
	1427 to 1606	25	45.5	-
	1695 to 1710	25	57.3	-
	1710 to 2690	29	37.7	-
	3300 to 3800	22	45.3	-
	4400 to 5000	27.5	29.9	-
	5150 to 5925	30	33.6	-
Middle to High (5G-L to 5G-H)	617 to 960	19	21.2	-
	1427 to 1606	25	29.8	-
	1710 to 2690	7.5	9.9	-
	3300 to 3600	14	16.8	-
	3600 to 3800	14	17.4	-
	4400 to 5000	11	13.4	-
Characteristic Impedance (ohm)		50 (Nominal)		

Ta = +25+/-5°C

All specifications are subject to change without notice.

TDK Technology - Proprietary and Confidential Information of TDK Group Companies

PRELIMINARYNov. 2018 Ver.1.4a
TDK Corporation**TPX255000MT-7066A1**■ **MAXIMUM RATINGS**

Parameter		TDK Spec		Conditions
		Min.	Max.	
Operating temperature (°C)		-40 to +90 °C		
Storage temperature (°C)		-40 to +90 °C		
Power Handling (dBm)	Common Port	-	30	CW
	Low-Band Port	-	36	CW
		-	-	
		-	-	
	Middle-Band Port	-	30	CW
High-Band Port	-	30	CW	
Human Body Model : HBM @Each Port (V)		-1000	1000	100pF / 1500ohm
Machine Model : MM @Each Port (V)		-150	150	200pF / 0ohm
Charged Device Model : CDM @Each Port (V)		-500	500	Relative humidity : 60%RH max

Ambient temperature : +25+/-5°C

PRELIMINARY

Nov. 2018 Ver.1.4a
TDK Corporation

TPX255000MT-7066A1

■ FREQUENCY CHARACTERISTICS

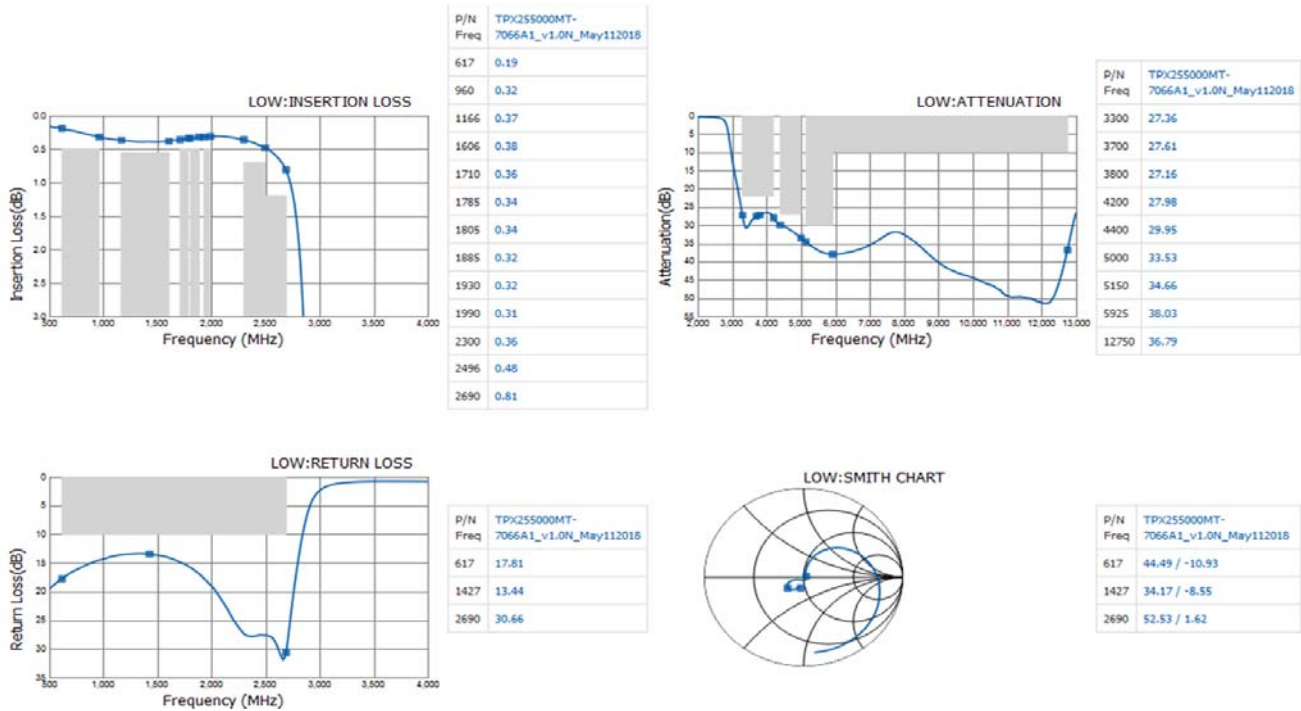

PRELIMINARY

Nov. 2018 Ver.1.4a
TDK Corporation

TPX255000MT-7066A1

FREQUENCY CHARACTERISTICS

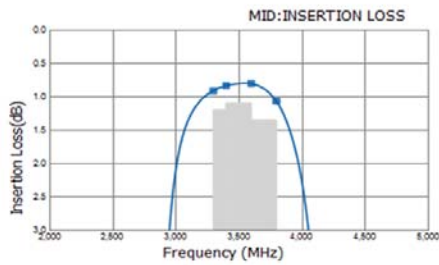

P/N	TPX255000MT-7066A1_v1.0N_May112018
3300	0.92
3400	0.84
3600	0.81
3800	1.07

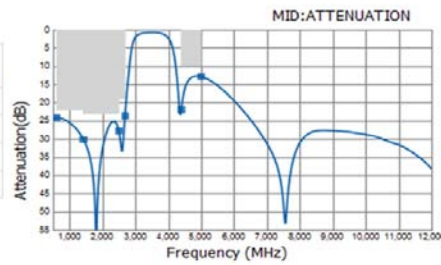

P/N	TPX255000MT-7066A1_v1.0N_May112018
617	24.23
1427	30.18
2500	27.83
2690	23.69
4400	21.98
5000	12.88

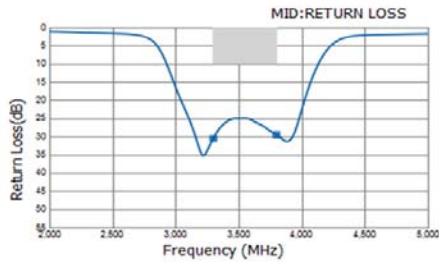

P/N	TPX255000MT-7066A1_v1.0N_May112018
3300	30.55
3600	29.55



P/N	TPX255000MT-7066A1_v1.0N_May112018
3300	52.42 / -1.84
3600	52.55 / -2.27

PRELIMINARY

Nov. 2018 Ver.1.4a
TDK Corporation

TPX255000MT-7066A1

FREQUENCY CHARACTERISTICS

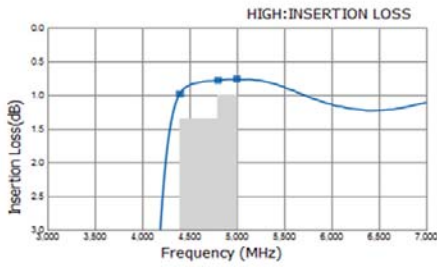

P/N	TPX255000MT-
Freq	7066A1_v1.0N_May112018
4400	0.98
4800	0.78
5000	0.76

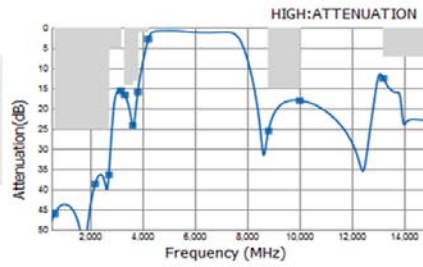

P/N	TPX255000MT-
Freq	7066A1_v1.0N_May112018
617	46.01
2170	38.60
2690	36.36
3150	15.62
3300	16.69
3600	24.21
3800	15.90
4200	2.84
8800	25.52
10000	18.02
13200	12.51
15000	22.33

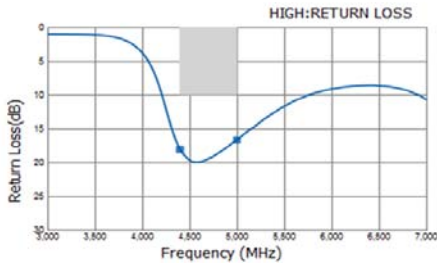

P/N	TPX255000MT-
Freq	7066A1_v1.0N_May112018
4400	18.12
5000	16.71

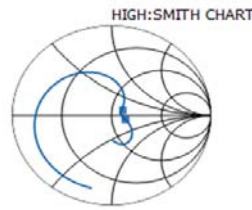

P/N	TPX255000MT-
Freq	7066A1_v1.0N_May112018
4400	61.14 / 8.21
5000	66.06 / -5.45

PRELIMINARY

Nov. 2018 Ver.1.4a
TDK Corporation

TPX255000MT-7066A1

FREQUENCY CHARACTERISTICS

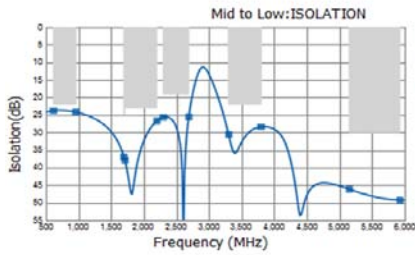

P/N	TPX255000MT-
Freq	7066A1_v1.0N_May112018
617	23.79
960	24.21
1695	36.90
1710	37.90
2200	26.71
2300	25.66
2690	25.59
3300	30.59
3800	28.38
5150	46.19
5925	49.36

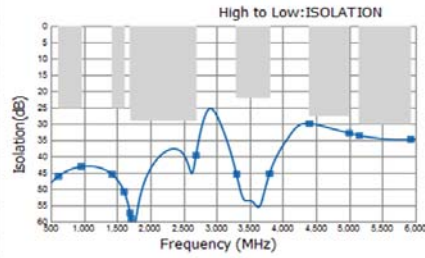

P/N	TPX255000MT-
Freq	7066A1_v1.0N_May112018
617	46.09
960	43.15
1427	45.52
1606	50.82
1695	57.33
1710	58.98
2690	39.72
3300	45.49
3800	45.26
4400	29.92
5000	32.90
5150	33.60
5925	34.79

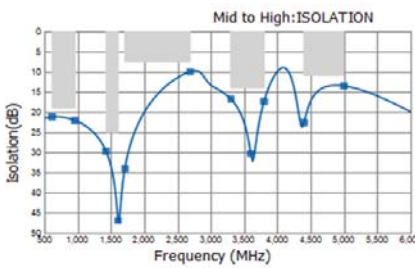

P/N	TPX255000MT-
Freq	7066A1_v1.0N_May112018
617	21.22
960	22.12
1427	29.75
1606	46.91
1710	34.04
2690	9.94
3300	16.81
3600	30.27
3800	17.38
4400	22.63
5000	13.52

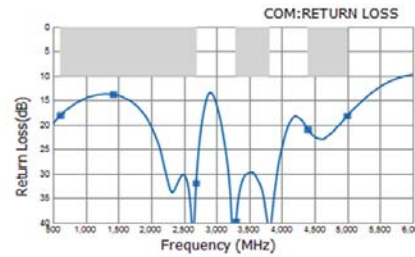

P/N	TPX255000MT-
Freq	7066A1_v1.0N_May112018
617	18.14
1427	13.84
2690	31.96
3300	39.73
3800	41.50
4400	21.03
5000	18.17

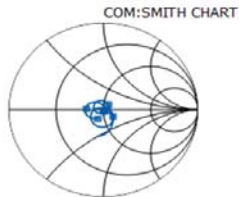

P/N	TPX255000MT-
Freq	7066A1_v1.0N_May112018
617	42.27 / -8.48
1427	33.13 / 1.07
2690	52.58 / 0.17
3300	50.05 / -1.03
3800	49.21 / -0.26
4400	54.62 / 8.1
5000	60.48 / -8.8

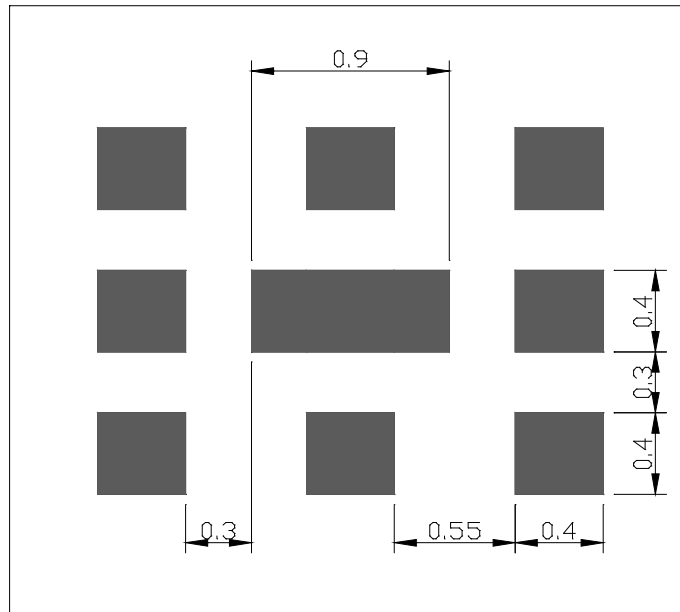
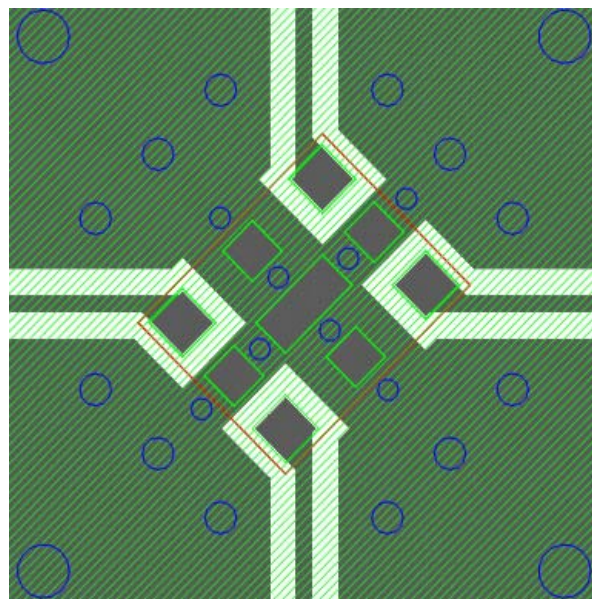
PRELIMINARYNov. 2018 Ver.1.4a
TDK Corporation**TPX255000MT-7066A1****RECOMMENDED LAND PATTERN****EVALUATION BOARD**

- Thru Hole
- ▨ Resist
- Surface Pattern
- DUT
- Direction Mark

Material, Layer	Thickness
Top Resist	Resist
Copper Surface Pattern	0.035mm
FR-4	0.10mm
Copper Inner GND	0.018mm
FR-4	0.30mm
Copper Bottom GND	0.035mm

ENVIRONMENT INFORMATION

RoHS Statement
RoHS Compliance

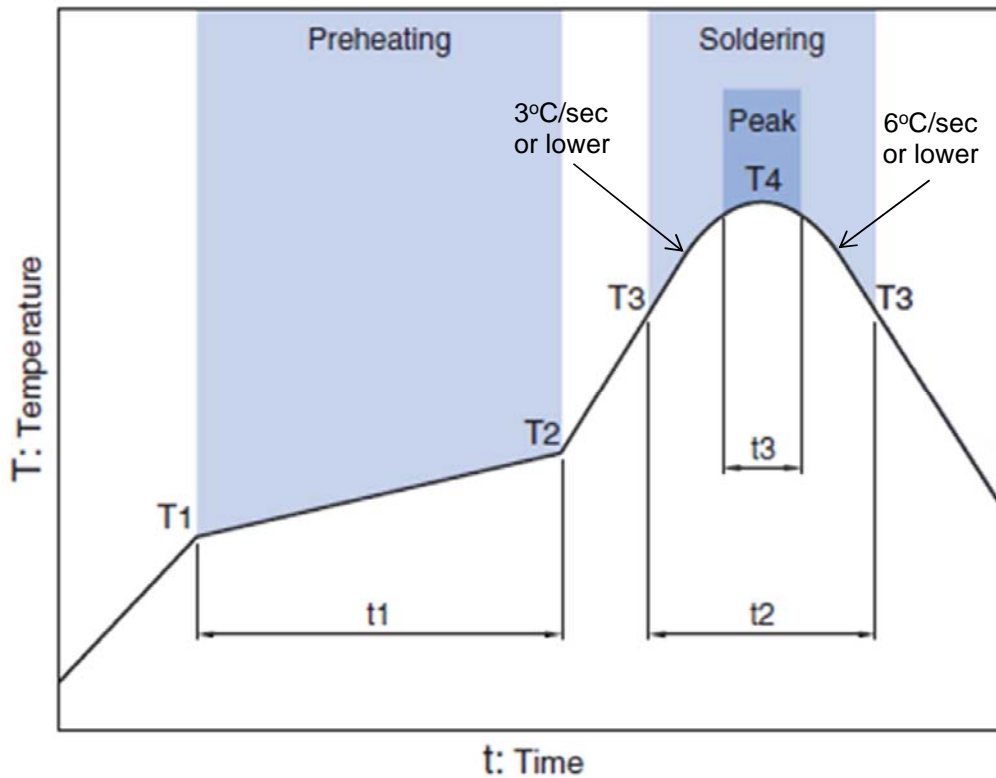
PRELIMINARYNov. 2018 Ver.1.4a
TDK Corporation**TPX255000MT-7066A1****RECOMMENDED REFLOW PROFILE**

Preheating			Soldering			
			Critical zone (T3 to T4)		Peak	
Temp.	Temp.	Time	Temp.	Time	Temp.	Time
T1	T2	t1	T3	t2	T4	t3 *
150°C	200°C	60 to 120sec	217°C	60 to 120sec	240 to 260°C	30 sec Max

* t3 : Time within 5°C of actual peak temperature

The maximum number of reflow is 3.

Note: Lead free solder is recommended.
Recommended solder is Sn-3.0Ag-0.5Cu. (M705 by Senju Metal Industry)

PRELIMINARYNov. 2018 Ver.1.4a
TDK Corporation**TPX255000MT-7066A1****PACKAGING STYLE**

Reel Dimensions

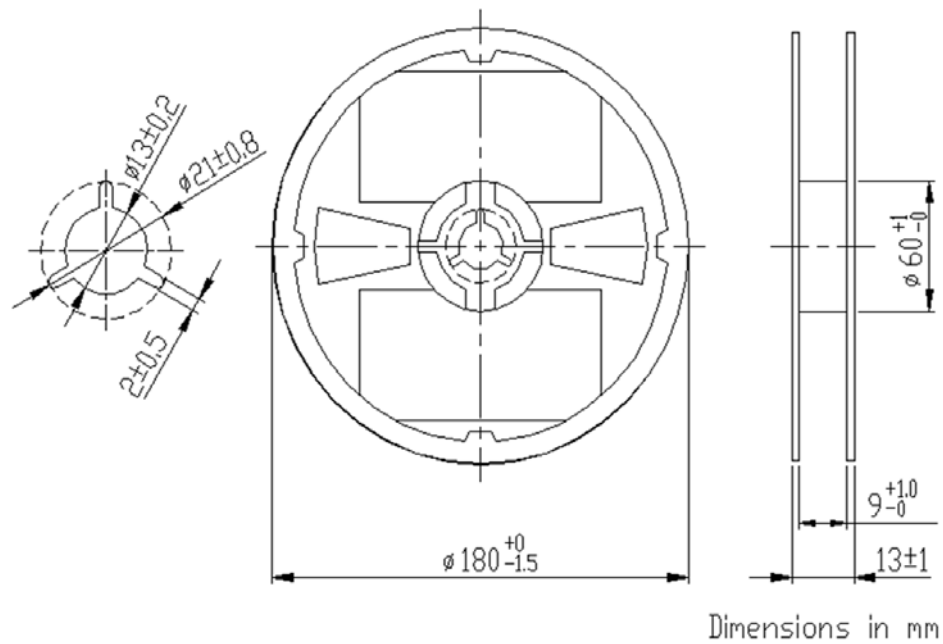

Carrier Tape

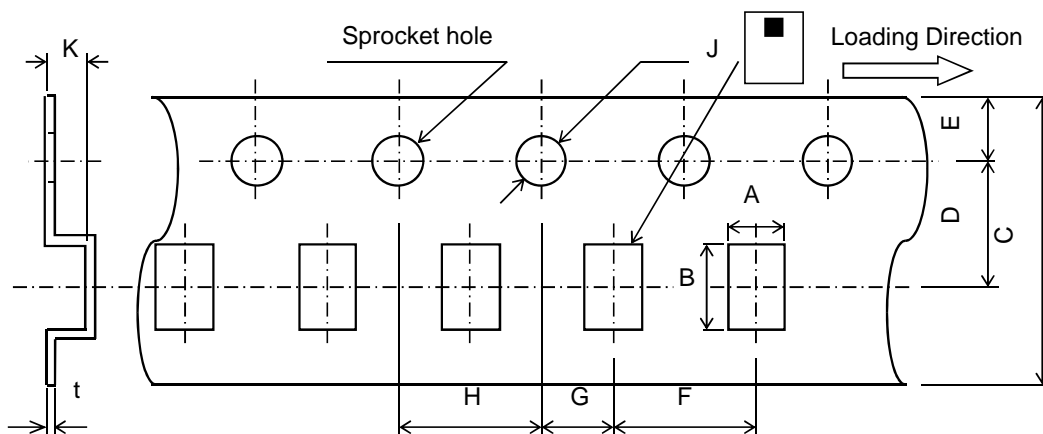

Dimensions (mm)

A	B	C	D	E	F	G	H	J	K	t
2.2	2.7	8.0	3.5	1.75	4.0	2.0	4.0	1.5	0.85	0.25
+/-0.05	+/-0.05	+0.3/-0.1	+/-0.05	+/-0.1	+/-0.1	+/-0.05	+/-0.1	+0.1/-0	MAX	+/-0.05

STANDARD PACKAGE QUANTITY
(pieces/reel)

2,000

REMINDERS FOR USING THESE PRODUCTS

Before using these products, be sure to request the delivery specifications.

SAFETY REMINDERS

Please pay sufficient attention to the warnings for safe designing when using these products.

REMINDERS

The products listed on this specification sheet are intended for use in general electronic equipment (AV equipment, telecommunications equipment, home appliances, amusement equipment, computer equipment, personal equipment, office equipment, measurement equipment, industrial robots) under a normal operation and use condition.

The products are not designed or warranted to meet the requirements of the applications listed below, whose performance and/or quality require a more stringent level of safety or reliability, or whose failure, malfunction or trouble could cause serious damage to society, person or property. Please understand that we are not responsible for any damage or liability caused by use of the products in any of the applications below or for any other use exceeding the range or conditions set forth in this specification sheet.

1. Aerospace/Aviation equipment
2. Transportation equipment (cars, electric trains, ships, etc.)
3. Medical equipment
4. Power-generation control equipment
5. Atomic energy-related equipment
6. Seabed equipment
7. Transportation control equipment
8. Public information-processing equipment
9. Military equipment
10. Electric heating apparatus, burning equipment
11. Disaster prevention/crime prevention equipment
12. Safety equipment
13. Other applications that are not considered general-purpose applications

When using this product in general-purpose applications, you are kindly requested to take into consideration securing protection circuit/equipment or providing backup circuits, etc., to ensure higher safety.