

Multi-Mode PWM Controller with Integrated Protections

Features

- Low Start-Up Current (<math><2\mu\text{A}</math>)
- Multi-Mode Operation
 - CCM @ Heavy Load and Low Line
 - QR-Like Operation @ Medium Load
 - Green mode with Valley Skip at Light Load
 - Burst Mode at No Load
- Accurate Over Current Protection
- Adjustment OVP on QRD Pin
- Output Short Protection
- Soft Driver
- 8ms Soft-start
- OVP (Over Voltage Protection) on Vcc Pin
- On Chip OTP Protection
- SOT-26 Package with Few External Components Needed

Description

The GR1230H is a high performance multi-mode (QR/CCM) PWM controller for flyback converter. It minimizes the components counts and is available in a tiny SOT-26 package. Those make it an ideal design for low cost application. It provides functions of low startup current, green- mode power-saving operation, VCC over-voltage protection, and QRD pin abnormal conditions sensing to prevent the circuit being damaged from the abnormal conditions.

Applications

- Switching AC/DC power adapter
- SMPS Power Supply

Typical Application Information

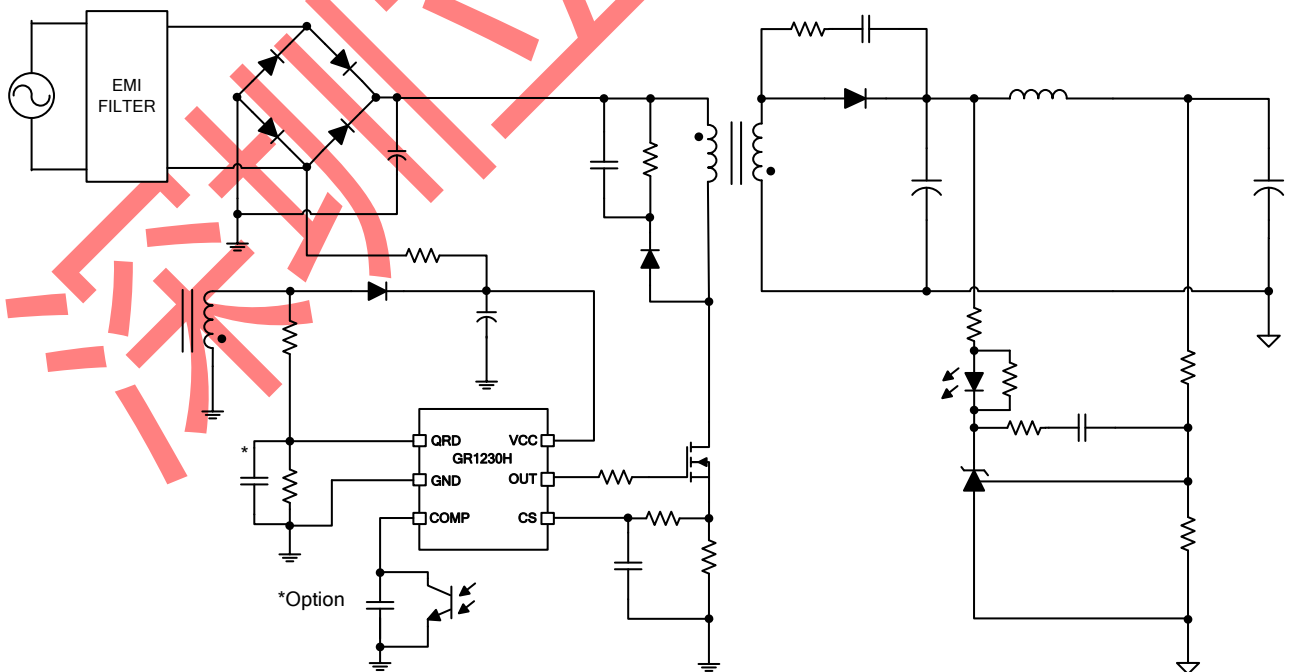

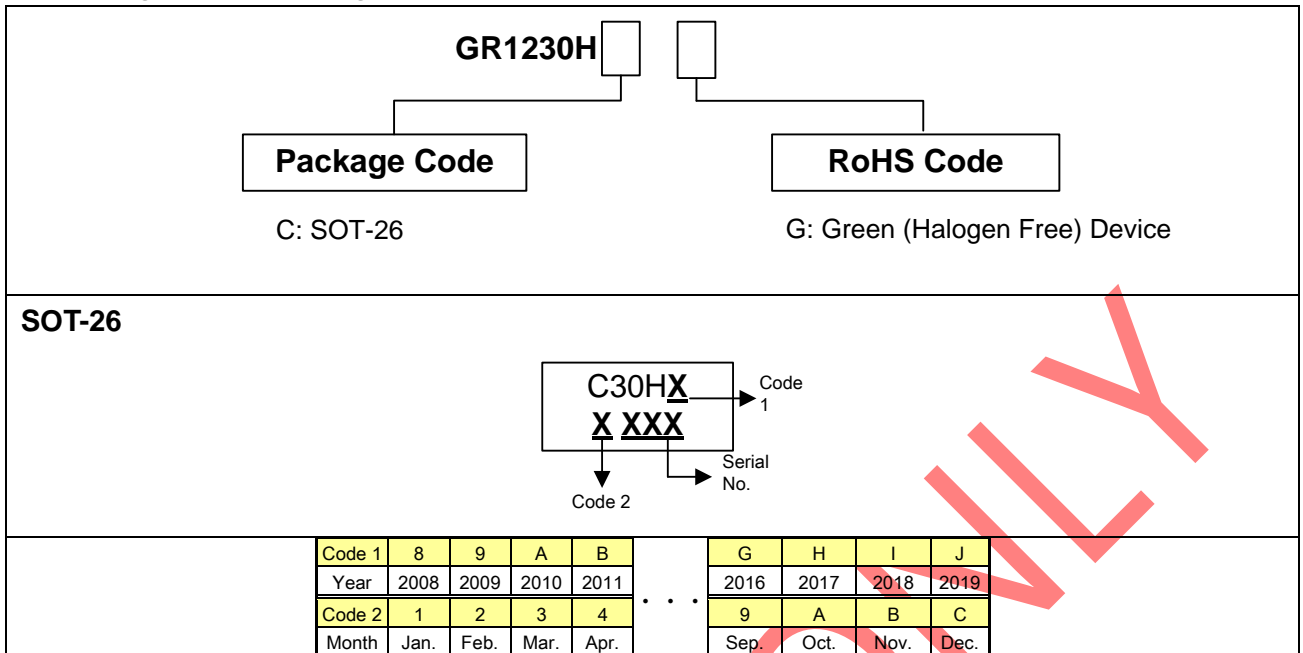
Ordering and Marking Information

Greenergy OPTO Inc. reserves the right to make changes to improve reliability or manufacture ability without notice, and advise customers to obtain the latest version of relevant information to verify before placing orders.

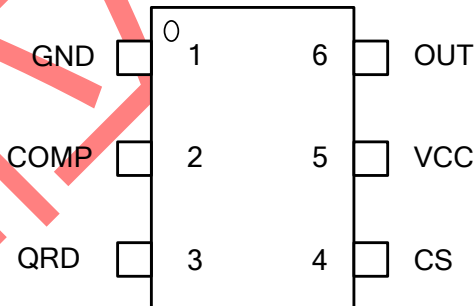
Pin Configuration
SOT-26 (TOP VIEW)

Pin Description

Pin No.	Name	Function
1	GND	Ground reference pin
2	COMP	Voltage feedback pin, by connecting a photo-coupler to control the duty cycle
3	QRD	This pin is for quasi-resonant detection and OVP.
4	CS	Current sense pin, connected to sense resistor for sensing the MOSFET current signal
5	VCC	Power supply pin
6	OUT	The output driver for driving the external MOSFET

Absolute Maximum Ratings

Supply voltage VCC	-----	30V
COMP, CS, QRD	-----	-0.3~6.0V
OUT	-----	-0.3~Vcc+0.3V
Junction temperature	-----	150°C
Storage temperature range	-----	-65°C ~ 150 °C
SOT-26 package thermal resistance	-----	250°C/W
Power dissipation (SOT-26, at ambient temperature = 85°C)	-----	250mW
Lead temperature (SOT-26 & DIP-8, soldering, 10 sec)	-----	230°C
Lead temperature (All Pb free packages, soldering, 10 sec)	-----	260°C
ESD, human body model	-----	2.5KV
ESD, machine model	-----	250V

Caution: The “Absolute Maximum Ratings” are those values beyond which the safety of the device cannot be guaranteed and may cause permanent damage to the IC. These are stress ratings only and functional operation of the device at these or any other condition beyond those indicated in the Electrical Characteristics section of the specification is not implied. The “Electrical Characteristics” table defines the conditions for actual device operation. Exposure to absolute maximum rated conditions for extended periods may affect device reliability

Recommended Operating Conditions

Item	Min.	Max.	Unit
Operating Junction temperature	-40	125	°C
Operating ambient temperature	-40	85	°C
Start Up Resistor (AC Half side)	540k	2.2M	Ω
Supply voltage VCC	9	26.5	V
VCC Capacitor	2.2	10	μF
COMP pin paralleling capacitor	1	33	nF
CS pin paralleling capacitor	100	1000	pF
QRD pin paralleling capacitor	NC	22	pF

Note:

- Not to exceed the maximum junction temperature of the IC, this relates to the operating power of the IC and the thermal resistance of the IC-package as above.
- The small signal components should be placed to IC pin as possible.
- It's essential to connect VCC pin with a SMD ceramic capacitor (0.1μF~0.47μF) to filter out the undesired switching noise for stable operation.
- Connecting a capacitor to COMP pin is also essential to filter out the undesired switching noise for stable operation.

Protection Mode

CCM Switching Frequency	OLP/UVP	VCC OVP	QRD OVP
100kHz	Auto recovery	Auto recovery	Auto recovery

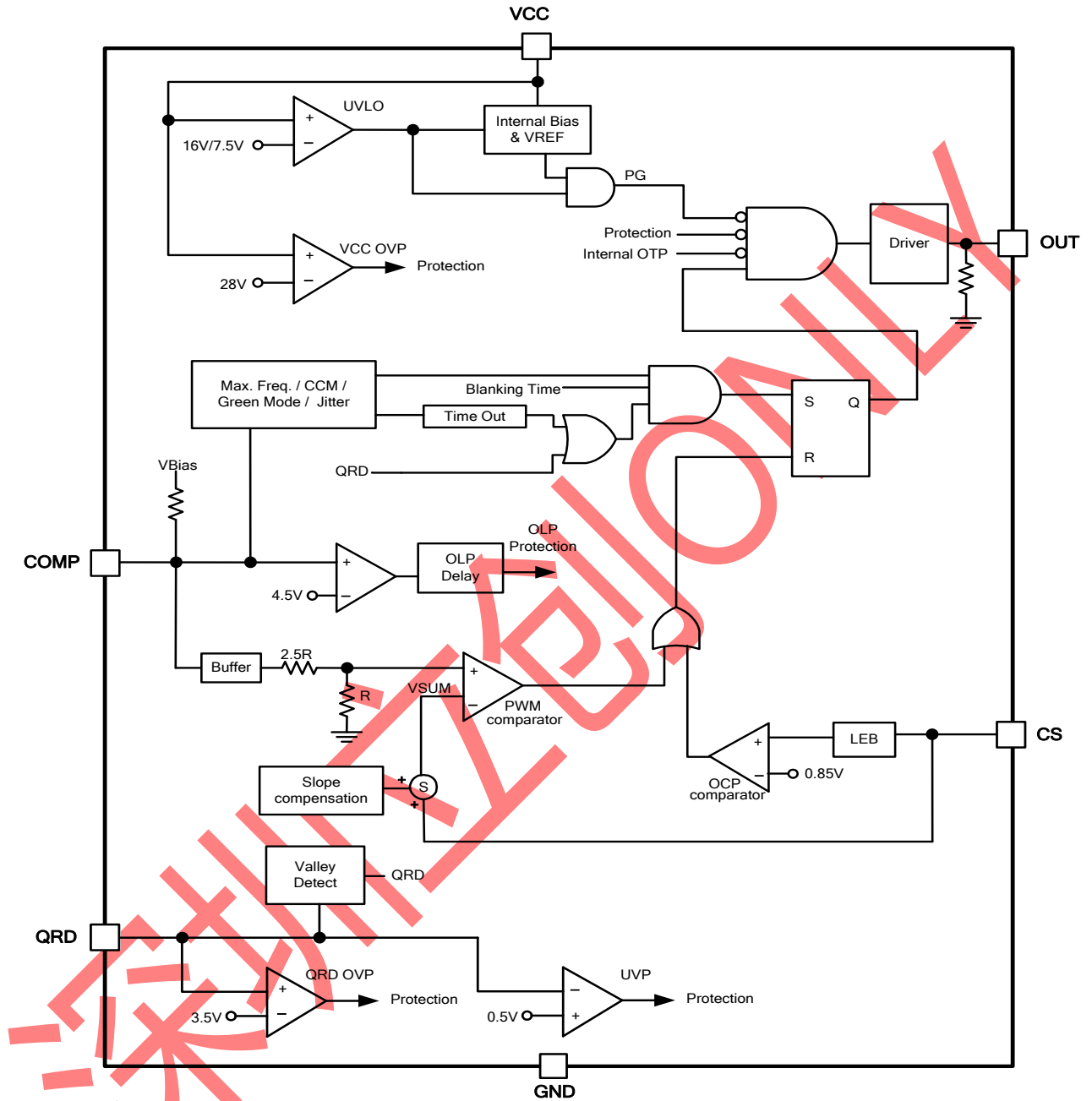
Block Diagram

Electrical Characteristics ($T_A = +25^\circ\text{C}$ unless otherwise stated, $V_{CC} = 15.0\text{V}$)

Parameter	Min.	Typ.	Max.	Unit
SUPPLY VOLTAGE (VCC Pin)				
Startup current $V_{CC} = UVLO\ ON - 0.1\text{V}$	0.75	1.5	2	μA
Operating current (with 1nF load on OUT pin), $V_{comp} = 0\text{V}$		0.65		mA
Operating current (with 1nF load on OUT pin), $V_{comp} = 2.5\text{V}$		2.1		mA
Operating current (with 1nF load on OUT pin), protection tripped (V_{CC} OVP, FB UVP)		0.65		mA
UVLO-OFF		7.5		V
UVLO-ON	15.2	16.0	16.8	V
VCC Mode Entry Point		8.5		V
Hysteresis		0.25		V
OVP level on VCC pin		28		V
OVP level on VCC pin Debounce Time*		128		μs
VOLTAGE FEEDBACK (COMP Pin)				
Short circuit current, $V_{comp} = 0\text{V}$		230		μA
Open loop voltage, COMP pin open	4.8	5.2	5.6	V
Maximum Frequency Threshold, $V_{S\text{MAX}}^*$		1.9		V
Green Mode Threshold*		1.49		V
Burst Mode Voltage		0.77		V
Hysteresis		100		mV
CURRENT SENSING (CS Pin)				
Maximum input voltage at Low Line, $V_{cs\text{max}}(\text{ON Time} > 4\mu\text{s}^*)$	0.80	0.85	0.90	V
Maximum input voltage at High Line, $V_{cs\text{maxL}}(\text{ON Time} < 3\mu\text{s}^*)$		0.7		V
Internal Slope Compensation*		0.3		V
Leading-edge blanking time		300		ns
Input impedance	1			$\text{M}\Omega$
Delay to Output*		100		ns
QRD (QRD Pin)				
Upper Clamp Level, $I_{ZCD} = 0.5\text{mA}$		4.6		V
Lower Clamp Level, $I_{ZCD} = -0.3\text{mA}$		-0.3		V
QRD Blanking Time		2.0		μs
QRD OVP	3.38	3.5	3.62	V
OVP De-bounce Time*		64		μs
UVP Level		0.5		V
UVP De-bounce Time after start-up*		8		ms

Electrical Characteristics ($T_A = +25^{\circ}\text{C}$ unless otherwise stated, $V_{CC} = 15.0\text{V}$)

Parameter	Min.	Typ.	Max.	Unit
OSCILLATOR				
CCM Frequency	92	100	108	kHz
Maximum Frequency Clamp, $V_{\text{comp}} > V_{\text{SMAX}}$		106		kHz
Green Mode Frequency		23		kHz
Jitter Frequency (CCM, $V_{\text{comp}} > V_{\text{Smax}}$)		± 8		%
Soft Start Time (CS Pin)				
Soft Start Time*		8		ms
GATE DRIVER OUTPUT (OUT Pin)				
Output low level, $V_{CC} = 15\text{V}$, $I_o = 20\text{mA}$			1	V
Output high level, $V_{CC} = 15\text{V}$, Out pin=1.5k Ω to GND	8			V
Output High Level, $V_{CC} = \text{UVLO-OFF} + 0.2\text{V}$	7		V_{CC}	V
Rising time, load capacitance = 1000pF*		330		ns
Falling time, load capacitance = 1000pF*		45		ns
VGATE-clamp ($V_{CC} = 17\text{V}$)		13.5		V
Maximum On Time		6.8		μs
Open Loop Protection (COMP Pin)				
OLP trip level, V_{comp}	4.2	4.35	4.5	V
OLP delay time after start-up	55	69	84	ms
Internal OTP (Guaranteed by design)				
OTP*		145		$^{\circ}\text{C}$
Hysteresis*		30		$^{\circ}\text{C}$

*Guaranteed by Design.

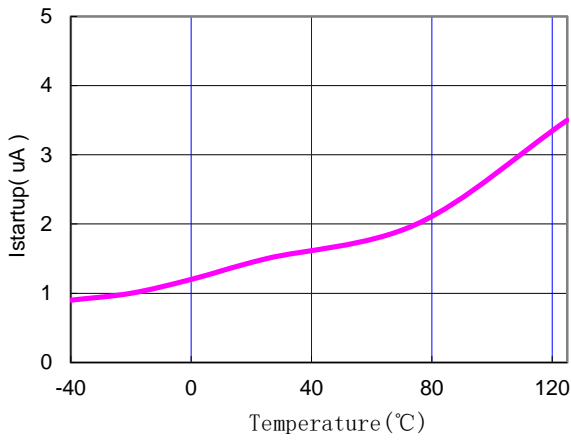
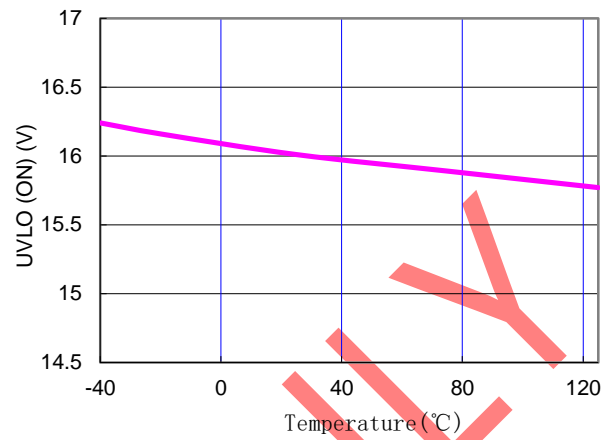
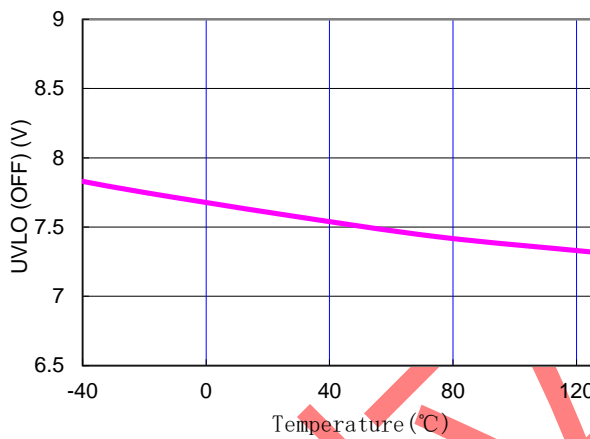
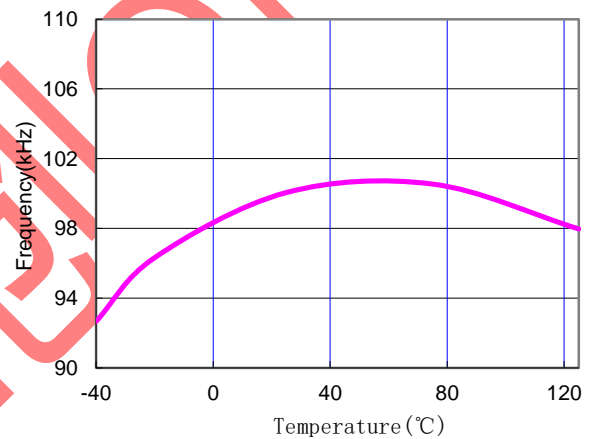
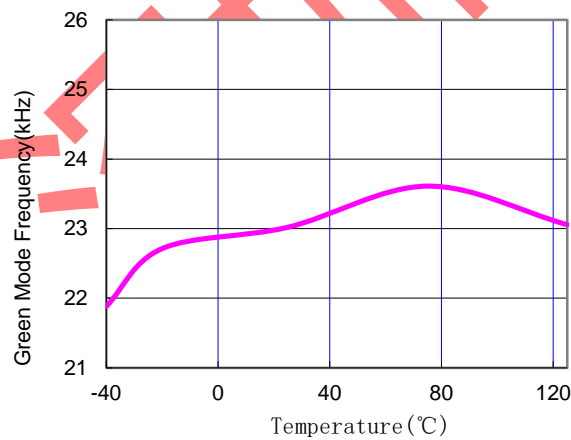
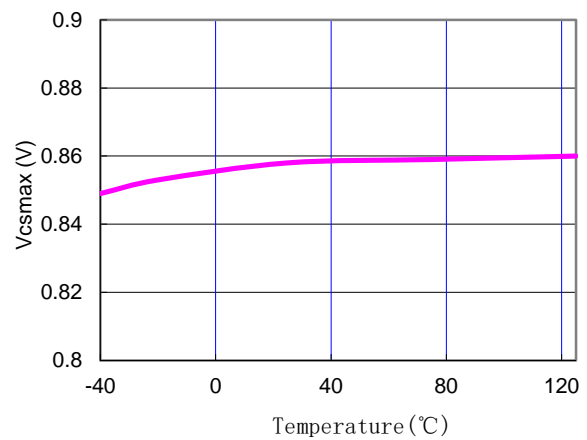
Typical Performance Characteristics

Fig. 1 Istartup current vs. Temperature

Fig. 2 UVLO (ON) vs. Temperature

Fig. 3 UVLO (OFF) vs. Temperature

Fig. 4 CCM Frequency vs. Temperature

Fig. 5 Green Mode Frequency vs. Temperature

Fig. 6 Vcsmax vs. Temperature

Typical Performance Characteristics

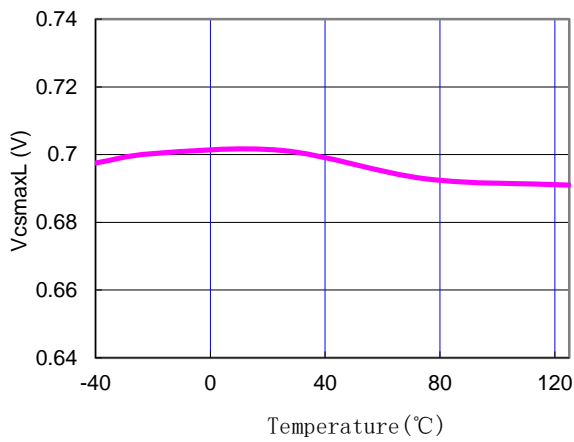

Fig. 7 VcsmaxL vs. Temperature

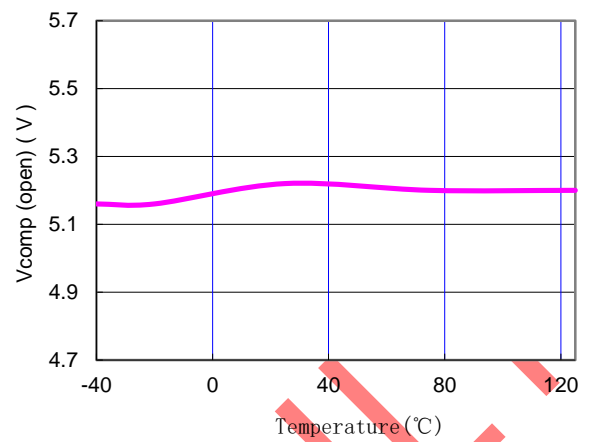

Fig. 8 Vcomp open loop voltage vs. Temperature

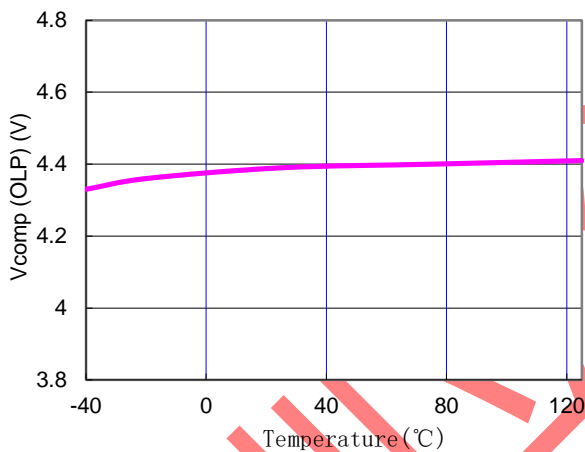

Fig. 9 Vcomp (OLP) vs. Temperature

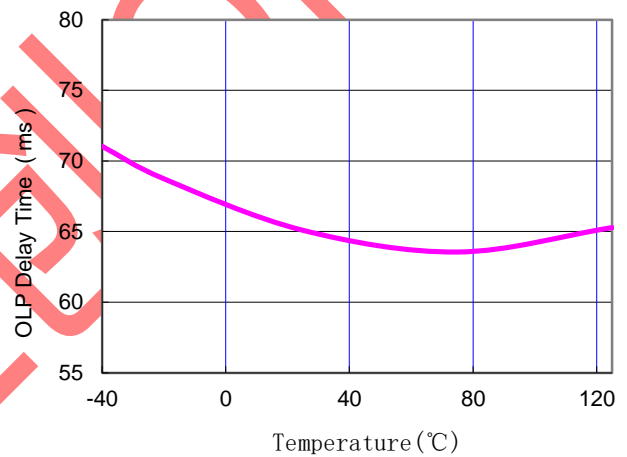

Fig. 10 OLP delay time vs. Temperature

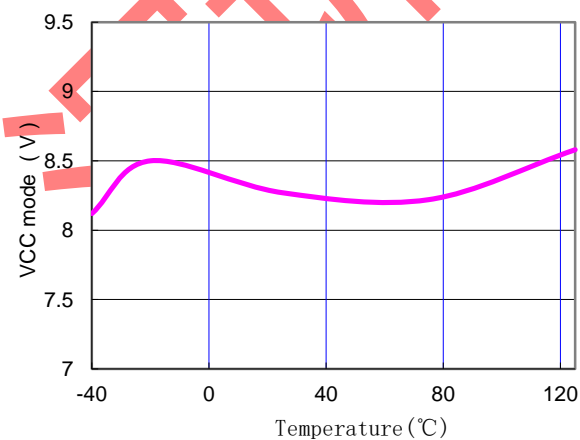

Fig. 11 VCC Mode (Entry) vs. Temperature

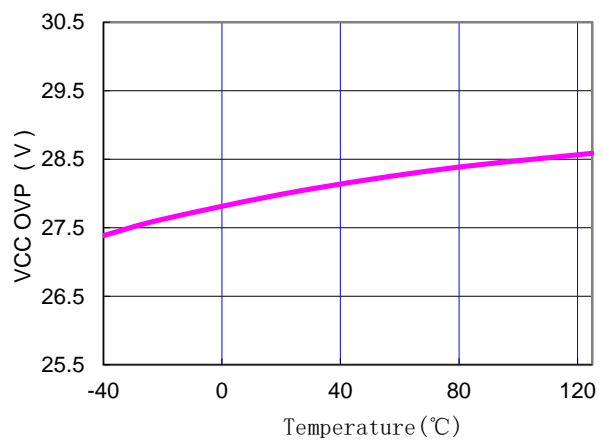

Fig. 12 VCC OVP vs. Temperature

Application Information

Overview

The GR1230H is a high performance multi-mode (QR/CCM) PWM controller for flyback converter. This results in a low-cost solution for low power AC/DC adapters. It integrated more functions to reduce the external components counts and the size. Its major features are described as below.

Start-up Current

The typical start-up current is 1.5uA. Very low start-up current allows the PWM controller to increase the value of start-up resistor and then reduce the power dissipation on it.

Under-voltage Lockout (UVLO)

A hysteresis UVLO comparator is implemented in GR1230H, then the turn-on and turn-off thresholds level are fixed at 16V and 7.5V respectively. This hysteresis shown in Fig.13 ensures that the start-up capacitor will be adequate to supply the chip during start-up.

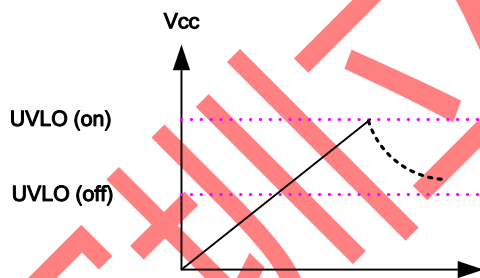

Fig.13

Multi-Mode Operation for High Efficiency

GR1230H is a multi-mode QR/CCM controller. The controller changes the mode of operation according to switching frequency and comp pin voltage, as shown in the Fig.14. At the normal operating condition, the IC operates in QR mode to reduce the switching loss. In the QR mode, the frequency varies depending on the line voltage and the load conditions. As the output load current is increased, the on-time T_{ON} is increased, and thus the switching

frequency decreases. If the switching frequency lowers than 100kHz frequency, the controller adaptively transitions to a CCM mode. Thus, small size transformer can be used with high power conversion efficiency.

As the output load current is decreased, the on-time T_{ON} is decreased, and thus the switching frequency increases. If the switching frequency increases till over the clamp of 106kHz, IC will skip the first valley to turn on in 2nd or 3rd valley.

At light load conditional, the V_{COMP} is lower than V_{SG1} and the system operates in green mode for high power conversion efficiency. The max switching frequency clamp will start to linearly decrease from 106kHz to 23kHz. The valley switching characteristic is still preserved in green mode. That is, when load decreases, the system automatically skip more and more valleys and the switching frequency is thus reduced.

At zero load or very light load conditions ($V_{comp} < \text{Burst mode voltage}$), the gate output pin of the GR1230H will be disabled immediately under such condition, enhancing power saving.

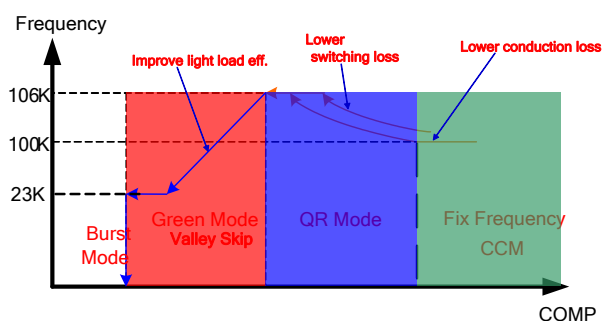

Fig.14

Quasi-Resonant Detection

The QR detection block will detect auxiliary winding voltage to turn on the MOSFET. The time-out2 generates a MOSFET turn-on signal as the driver output drops to low level for more than 150μs (Time Out) with the falling edge of the driver output.

Leading-edge Blanking (LEB)

Each time the power MOSFET is switched on, a turn-on spike will inevitably occur at the sense resistor. To avoid fault trigger, a leading-edge blanking time is built in. During this blanking period, the current-limit comparator is disabled and cannot switch off the gate driver.

Internal Slope Compensation

A built-in slope compensation circuit is constructed in GR1230H. When the switch is on, a ramp voltage is added to the sensed voltage across the CS pin, which helps to stabilize the system and prevent sub-harmonic oscillations.

Over-voltage Protection (OVP) on VCC Auto Recovery mode

To prevent power MOSFET from being damaged, the GR1230H is implemented an OVP function on VCC. When the VCC voltage is higher than the OVP threshold voltage, the output gate driver circuit will be shut down immediately to stop the switching of power MOSFET. The VCC OVP function is an auto-recovery type protection. If OVP happens, the pulses will be stopped and recover at the next UVLO on. The GR1230H is working in a hiccup mode as shown in Fig. 15.

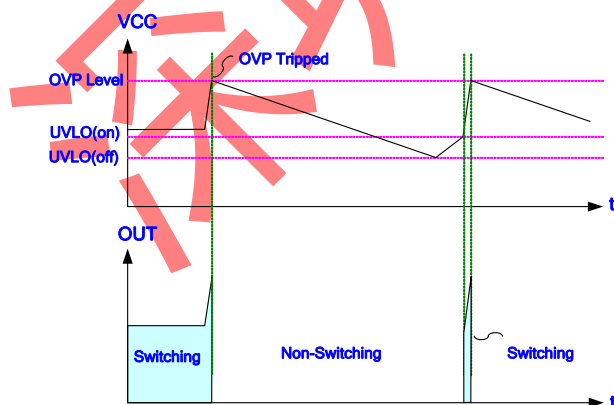

Fig.15

Output OVP on QRD - Auto Recovery mode

An output overvoltage protection is implemented in the GR1230H, as shown in Fig. 16 and 17. It senses the auxiliary voltage via the divided resistors. The overvoltage protection works by sampling the plateau voltage after a delay time. The sampling voltage level is compared with internal threshold voltage 3.5V. If the sampling voltage exceeds the QRD OVP trip level, the QRD OVP circuit switches the power MOSFET off. The QRD OVP function is an auto-recovery type protection. The de-bounce time of QRD OVP is 64 μ s to prevent incorrect OVP detection which might occur during ESD or lightning events.

Output Under-voltage Protection (UVP) on QRD- Auto Recovery mode

To protect the circuit from damage due to output short condition, an auto-recovery type of UVP protection is implemented for it. If the QRD voltage declines below 0.5V for over the 8ms, the protection will be activated to turn off the gate until the next UVLO-ON. It may connect QRD pin with a SMD ceramic capacitor (C_Q :4.7~22pF) to filter out the undesired switching noise for stable operation.

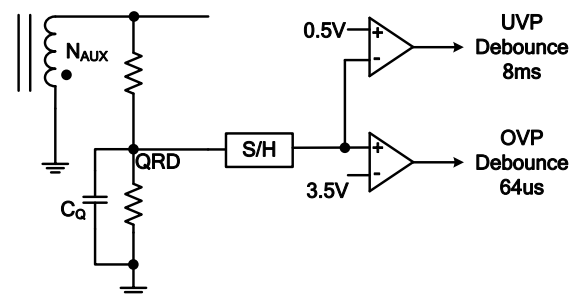

Fig.16

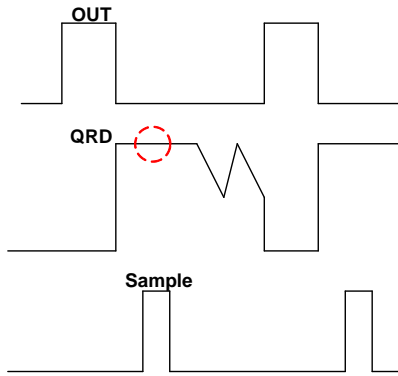

Fig.17

OLP (Open Loop Protection) – Auto Recovery mode

The GR1230H has open loop protection function. An internal circuit detects the V_{comp} level, when the V_{comp} is larger than an OLP threshold level and continues over OLP delay time, the protection will be activated and then turn off the gate output to stop the switching of power circuit. Then VCC decreases below UVLO off level, the controller resets again.

Gate Clamp/Soft Driving

Driver output is clamped by an internal 13.5V clamping circuit to prevent from undesired over-voltage gate signals. And under the conditions listed below, the gate output will turn off immediately to protect the power circuit. The GR1230H also has soft driving function to minimize EMI.

VCC Mode Operation

In order to avoid the output voltage shut down by load changing from full to no load, the GR1230H is built-in the VCC mode function. When the load from full changes to no load, the output voltage will overshoot and pull low the COMP pin by feedback loop (Into burst mode). Thus the duty will disappear and no power delivers to the secondary. If there is without any mechanism to prevent this situation, the VCC pin voltage will down to UVLO off and the IC will re-start again. In the GR1230H, before the VCC is down to UVLO off, it will force the OUT pin outputs the specified duty to pull the VCC higher than UVLO off.

The VCC mode function is used to prevent the output re-start again when load changes. So never let the system operate on the VCC mode at no load. The system should operate on burst mode, otherwise the input power maybe become larger.

Fault Protection

There are several critical protections integrated in the

- . CS pin floating
- . Comp pin shorting
- . Comp pin floating
- . QRD pin shorting

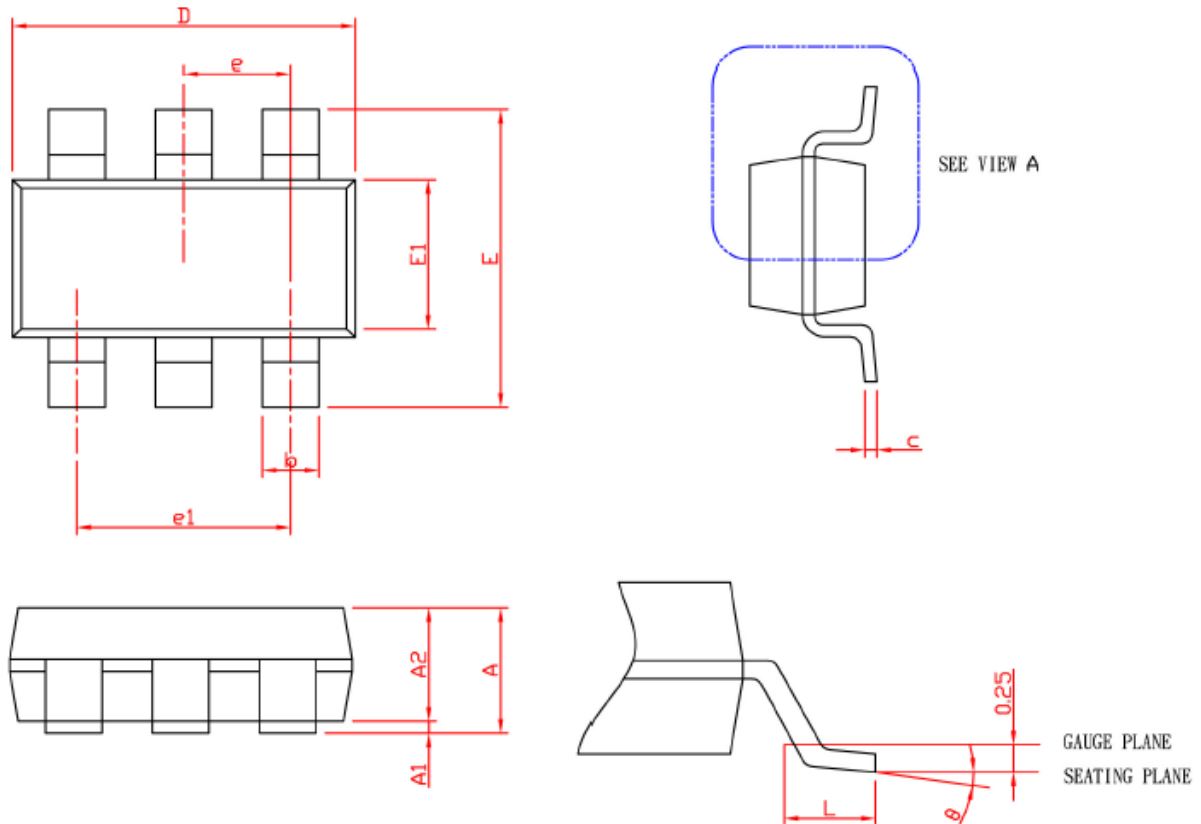
Package Information
SOT-26

SYMBOL	SOT-26			
	MILLIMETERS		INCHES	
	MIN.	MAX.	MIN.	MAX.
A		1.45		0.057
A1	0.00	0.15	0.000	0.006
A2	0.90	1.30	0.035	0.051
b	0.30	0.50	0.012	0.020
c	0.08	0.22	0.003	0.009
D	2.70	3.10	0.106	0.122
E	2.60	3.00	0.102	0.118
E1	1.40	1.80	0.055	0.071
e	0.95 BSC		0.037 BSC	
e1	1.90 BSC		0.075 BSC	
L	0.30	0.60	0.012	0.024
θ	0°	8°	0°	8°

Note: 1. Followed from JEDEC MO-178 AB.

2. Dimension D and E1 do not include mold flash, protrusions or gate burrs. Mold flash, protrusions or gate burrs shall not exceed 10 mil per side

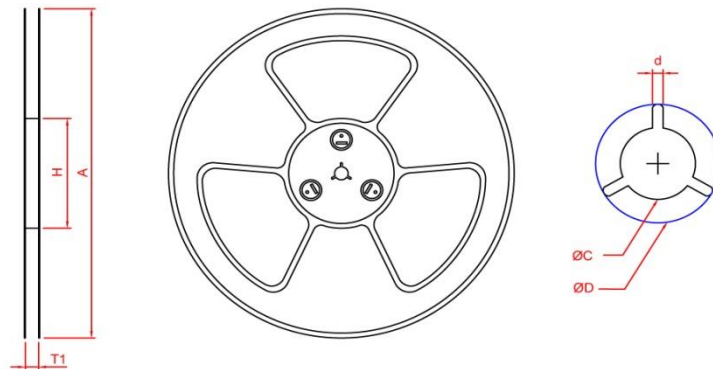
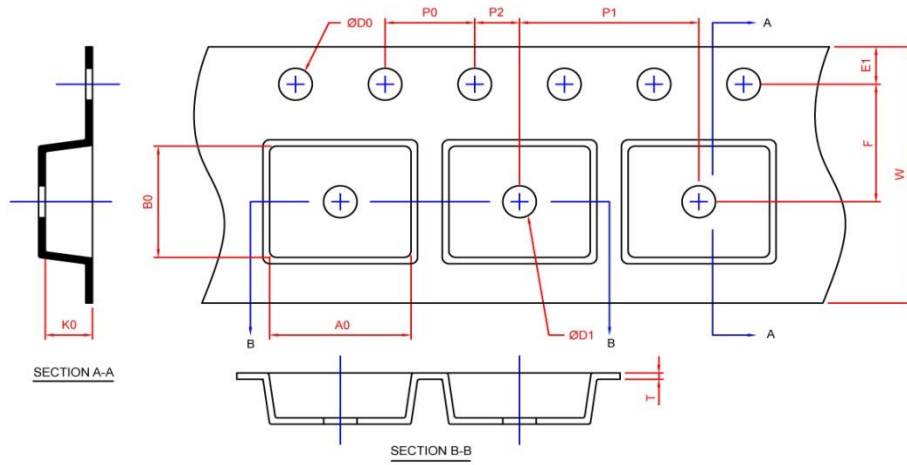
Carrier Tape & Reel Dimensions
SOT-26

Application	A	H	T1	C	d	D	W	E1	F
SOT-26	178.0±2.00	50 MIN.	8.4+2.00 -0.00	13.0+0.50 -0.20	1.5 MIN.	20.2 MIN.	8.0±0.30	1.75±0.10	3.5±0.05
	P0	P1	P2	D0	D1	T	A0	B0	K0
	4.0±0.10	4.0±0.10	2.0±0.05	1.5+0.10 -0.00	1.0 MIN.	0.6+0.00 -0.40	3.20±0.20	3.10±0.20	1.50±0.20

Application	Carrier Width	Cover Tape Width	Devices Per Reel
SOT -26	8	5.3	3000

(mm)

Tape and Specification Reel

SOT 26

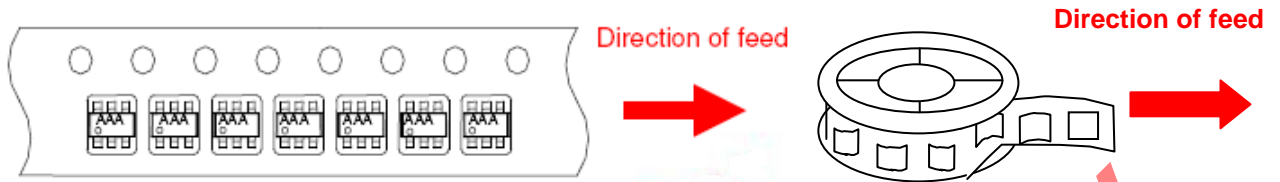

深圳立包ONLY