



重庆市灵龙电子有限公司

CHONGQING LINGLONG ELECTRONIC CO., LTD.

承 认 书

SPECIFICATION FOR APPROVAL

客 户Customer:

项目名称Project:

规格型号Part No:

10G30F-070312089-8344B

客 户 确 认/ Customer Approved	
料 号/ Part No.	签 章/ Signatures

地址: 中国重庆市北部新区经开园灵龙工业区
Add: Linglong Industrial Zone, Northern Area of
CETZ, Chongqing P.R.China.
电话/Tel: 86-23-67463788
传真/Fax: 86-23-67463766
Http: //www.lnlon.com
E-mail: lnlon@lnlon.com

存货编码/Stock	30103040012
拟制/Drawn	陈君
审核/Check	秦代伟
批准/Approved	章启策

	产品规格书/specification	No	LL-3-J-33251	
		版本Revision	A.1	
	存货编码/Stock code.: 30103040012	页码Page	2 of 10	
		日期Date	2020-9-24	

1. 适用范围/General

本规格书适用于重庆灵龙电子有限公司所提供的产品: 10G30F-070312089-8344B

The specification is applicable to Inlon's part: 10G30F-070312089-8344B

2. 使用条件/Operating condition

No	项目/Item	规格/Specification
2-1	额定电压 Rated voltage	3.0 V DC
2-2	使用电压范围 Operating voltage	2.7~3.3V DC
2-3	旋转方向 Rotatio no rientation	CW(clockwise)
2-4	马达位置 Motor position	全方位 All positions
2-5	使用环境 Operating environment	-20~60℃, 10~90% (RH) 无水气凝结 No coagulation of moisture
2-6	保存环境 Storage environment	-30~70℃, 10~90% (RH) 无水气凝结 No coagulation of moisture

3. 测量条件/Measuring condition

一般情况下, 马达可以在5~35℃, 相对湿度45~85% (RH) 的环境中测试。为了保证一致性, 测试应在下表规定内进行
Normally, it should be tested under 5~35℃, 45~85% (RH) .To ensure the coherence, it must be tested according to the below chart.

No	项目/Item	规格/Specification
3-1	温度 Temperature	25±3℃
3-2	湿度 Humidity	(63%~67%) RH
3-3	位置 Motor position	马达水平放置/lay motor horizontally

4. 机械要求/Mechanical specification

No	项目/Item	规格/Specification	测定条件/备注 Measuring condiction s/Remark
4-1	外观 Appearance	不应有明显的机械损伤、锈蚀等现象 No evidence of machanical damage, rust corrsion, and so on.	目视检查 Visual examination
4-2	尺寸 Dimensions	见外形图 As specified in outline drawing	使用游标卡尺或千分尺测量 Test with vernier caliper or micrometer

	产品规格书/specification	No	LL-3-J-33251
		版本Revision	A.1
	存货编码/Stock code.: 30103040012	页码Page	3 of 10
		日期Date	2020-9-24

5. 性能特征/Performance and characteristics

No	项目/Item	规格/Specification		测定条件/备注 Measuring condictions/Remark
5-1	额定转速 Rated speed	13000±3000 rpm		在额定电压和额定负载下。 At rated voltage and rated load .
5-2	额定电流 Rated current	85 mA Max		
5-3	启动电压 Starting voltage	2.3V DC Max		在额定负载下转子的任意位置。 At rated load any position of rotor.
5-4	端子阻抗 Terminal resistance	相接触 Phase contact	34 Ω ±15%	在两接触脚之间测量 Test between the two touch pins
		相串联 Phase senrial	56 Ω ±15%	
		相并联 Phase parallel	18 Ω ±15%	
5-5	绝缘电阻 Insulation resistance	10MΩ Min		在100V 直流电压下，导线和机壳间进行测量 Test between lead wire and case at DC 100V
5-6	振动量 Vibration quantity	1.6G Min		见下图 See beow
	<p>额定电压下, 电机固定在90*50*8的铝制板夹具(约100g)的左边, 夹具垂直悬空或放在海棉垫上. 将加速度感应器用双面胶粘在电机所对应的夹具的右边 (如图所示). 使用VM-83振动仪, 参数设置如下: 加速度(m/s²): 30 HPF (HZ): 50 LPF (HZ): 300 探测方式: RMS</p> <p>At rated voltage, fasten the motor upto the left of aluminium-board jigu (size:90*50*8), which is upright and hanged in the air or upon the sponge. Adhibit the acceleration inductor to the right side of the jig with double-faced tape(as right drawing). Use the apparatus VM-83, the parameter is as below: Acceleration(m/s²): 30 HPF (HZ): 50 LPF (HZ): 300</p>			

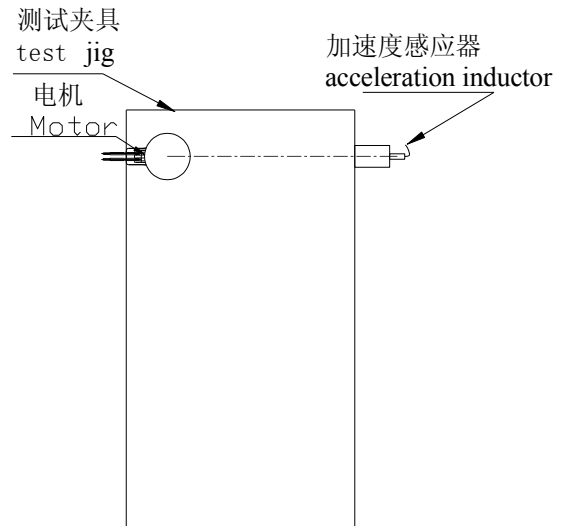

	产品规格书/specification	No	LL-3-J-33251
		版本Revision	A.1
	存货编码/Stock code.: 30103040012	页码Page	4 of 10
		日期Date	2020-9-24

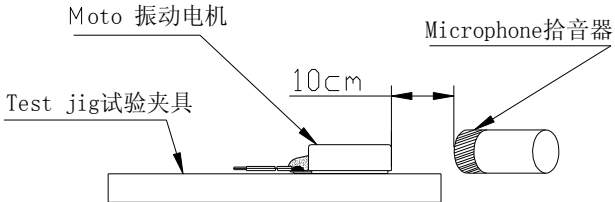
No	项目/Item	规格/Specification	测定条件/备注 Measuring conditions/Remark
5-7	机械噪音 Mechanical noise	小于50分贝.A计权 50db(A)Max 50	见下图: See below
<p>额定电压下,背景噪声≤28 dB(A),电机轴向水平固定在测试夹具上(100g),拾音器沿轴向正对电机平面,距离10cm At rated voltage and scene noise as 28dB(A)Max,the shaft is horizontally fastened to the test jig(100g).The Microphone faces the plane of motor along the shaft.The distance is 10cm.</p> <div style="display: flex; align-items: center; justify-content: center;">  </div>			

6. 可靠性/Reliability

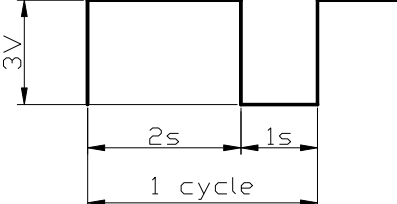
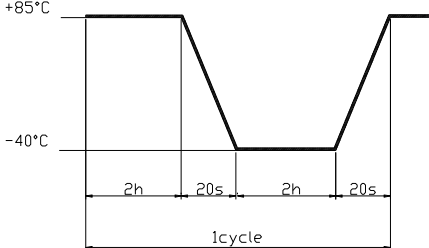
No	项目/Item	测试条件/Specification	判定标准/Judgment
6-1	寿命 Life	 <p>常温常湿下共循环100000次。 Cycle 100000times in the ordinary temperature and humidity.</p>	<p>在常温常湿下放置4h后,电机性能应符合以下要求。</p> <ol style="list-style-type: none"> 1) 额定转速:指标不低于初始值-30%;不高于初始值+50% 2) 额定电流:指标在初始值±30%以内。 3) 起动电压:2.3V DC Max直流电压。 <p>After 4h exposure in the ordinary temperature and humidity,the motor's performance should accord with below requirements:</p> <ol style="list-style-type: none"> 1) Rated speed:Data-30% Initial Min, Data+50% Initial Max. 2) Rated current:Data±30% Max. 3) Starting voltage: 2.3V DC Max
6-2	低温贮存放置 Low temperature storage test	温度Temperature: -40±2℃ 时间Time: 96h	<p>在常温常湿下放置4h后,电机性能应符合以下要求。</p> <ol style="list-style-type: none"> 1) 额定转速:指标在初始值±30%以内。 2) 额定电流:指标在初始值±30%以内。 3) 起动电压:2.3V DC Max直流电压。
6-3	高温贮存放置 High temperature storage test	温度Temperature:80±2℃ 时间Time:96h	<p>After 4h exposure in the ordinary temperature and humidity,the motor's performance should accord with below requirements:</p> <ol style="list-style-type: none"> 1) Rated speed:Data±30% Max 2) Rated current:Data±30% Max. 3) Starting voltage: 2.3V DC Max
6-4	湿度放置 Humidity exposure	温度Temperature: 60±2℃ 湿度Humidity: 90~95RH 放置时间Exposure time: 96h	
6-5	热冲击 Heat stock test	 <p>周期Period : 32times</p>	<p>在常温常湿下放置4h后,电机性能应符合以下要求。</p> <ol style="list-style-type: none"> 1) 额定转速:指标在初始值±30%以内。 2) 额定电流:指标在初始值±30%以内。 3) 起动电压:2.3V DC Max直流电压。 <p>After 4h exposure in the ordinary temperature and humidity,the motor's performance should accord with below requirements:</p> <ol style="list-style-type: none"> 1) Rated speed:Data±30% Max 2) Rated current:Data±30% Max. 3) Starting voltage: 2.3V DC Max

	产品规格书/specification	No	LL-3-J-33251
		版本Revision	A.1
	存货编码/Stock code.: 30103040012	页码Page	5 of 10
		日期Date	2020-9-24

No	项目/Item	测试条件/Specification	判定标准/Judgment
6-6	振动 Vibration	全振幅Full swing:1.5mm (p-p) 频率Frequency:10 to 55Hz 周期Cycle:20min (10~55~10Hz) 方向Orientation:x、y、z 时间Time:2h	在常温常湿下放置4h后, 电机性能应符合条款5:性能特征要求. After 4h exposure in the ordinary temperature and humidity, the motor's performance should accord with item 5:Performance requirements.
6-7	自然跌落 Free fall	试验状态:将马达固定在约100克(包括马达本身)的物体上, 落向水泥地面。 高度:1.5m 方向:±x. ±y. ±z 次数:每个方向2次 Test state:Fasten the motor onto a object(100g) and then let it fall down to the ground. Height:1.5m Orientation:±x. ±y. ±z Times:2times per orientation	在常温常湿下放置4h后, 电机性能应符合条款5:性能特征要求. After 4h exposure in the ordinary temperature and humidity, the motor's performance should accord with item 5:Performance requirements.
6-8	滚筒试验 Barrel roll test	滚筒高度:1.0M, 滚筒次数300次. 滚筒速率13±1次/分钟 Height:1.0M Times:300times. Speed:13±1times/M	在常温常湿下放置4h后, 电机性能应符合以下要求。 1) 额定转速:指标在初始值±30%以内。 2) 额定电流:指标在初始值±30%以内。 3) 起动电压:2.3V DC Max直流电压。 After 4h exposure in the ordinary temperature and humidity, the motor's performance should accord with below requirements: 1) Rated speed:Data±30% Max 2) Rated current:Data±30% Max. 3) Starting voltage: 2.3V DC Max

7. 环境管理物质/Environmental management materials:

7.1 本产品应符合RoHS指令要求和无卤素要求。

The product should be in compliance with RoHS requirements:

* 镉及其化合物最大允许含量为100PPM

Cadmium and Compound:100PPM Max

* 铅及其化合物最大允许含量为1000PPM

Lead and Compound:1000PPM Max

* 汞及其化合物最大允许含量为1000PPM

Hydrargyrum and Compound:1000PPM Max

* 六价铬及其化合物最大允许含量为1000PPM

+6 Chromium and Compound:1000PPM Max

* 多溴联苯及其化合物最大允许含量为1000PPM

PBB and Compound:1000PPM Max

	产品规格书/specification	No	LL-3-J-33251
		版本Revision	A.1
	存货编码/Stock code.: 30103040012	页码Page	6 of 10
		日期Date	2020-9-24

*多溴二苯醚及其化合物最大允许含量为1000PPM

PBDE and Compound:1000PPM Max

*氯溴两种卤素之和最大允许含量为1500PPM

The allowed content of Cl,Br is 1500PPM Max for total.

*氯卤素最大允许含量为900PPM

The allowed content of Cl is 900PPM Max.

*溴卤素最大允许含量为900PPM

The allowed content of Br is 900PPM Max.

7.2本品含有以下物质,是RoHS指令豁免项

The product contains below materials, which are released from RoHS:

NO	品名 Part No.	材质 Material	含有物质 Substance included	最大允许含量 Max content	部品重量 Parts Weight
1	含油轴承 Bearing with Oil	铜合金 Copper alloy	铅 Lead	40000PPM	≈0.03g

8. 电机结构图/Motor configuratoin drawing

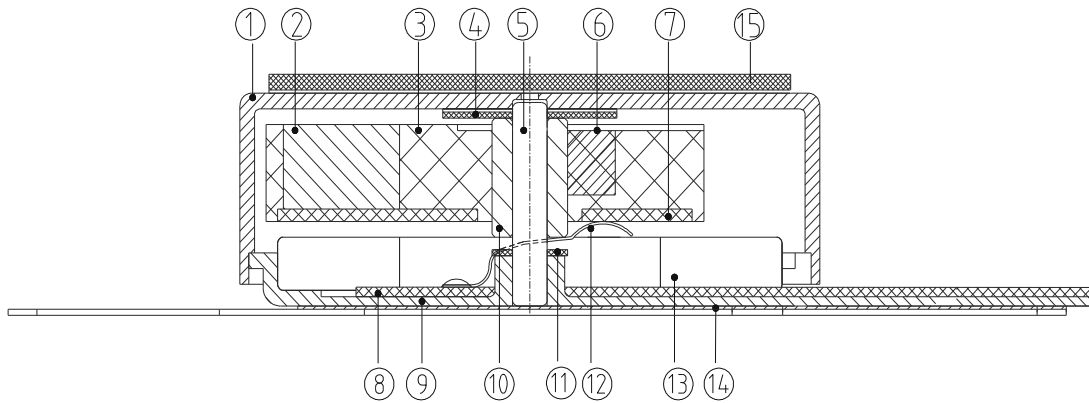

NO	名称/Name	NO	名称/Name
1	上机壳upper case	8	软PCB板Soft PCB
2	振子weight	9	下机壳lower case
3	塑料Plastic	10	含油轴承oil bearing
4	粘性垫片Adhesive mat patch	11	垫圈Gasket
5	轴shaft	12	电刷Brush
6	线圈Coil	13	磁钢Alnico
7	硬PCB板Hard PCB	14	双面胶Double-face tape
		15	海绵垫foam

9. 电机外形图/Motor outline drawing:

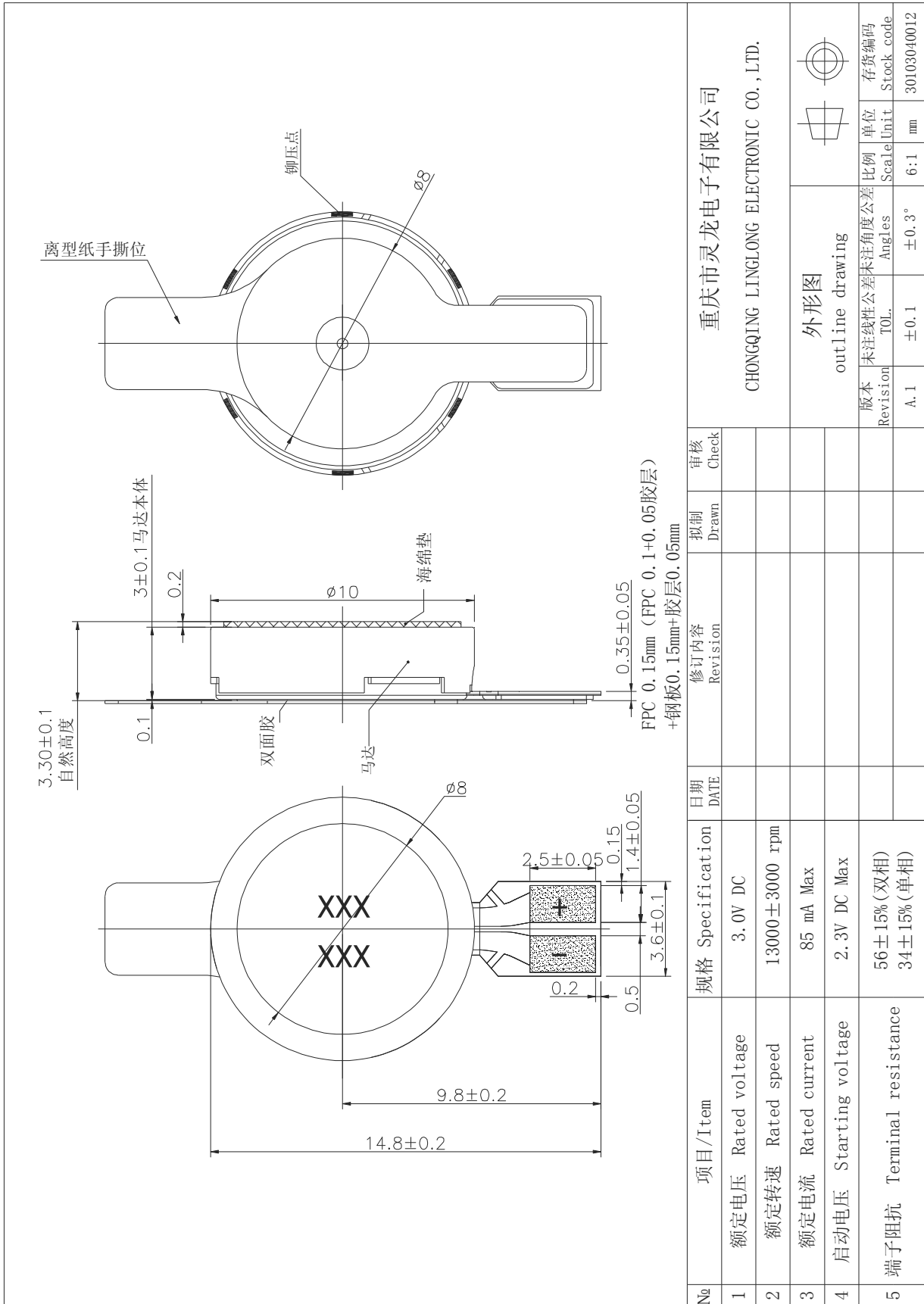

重庆市灵龙电子有限公司

CHONGQING LINGLONG ELECTRONIC CO., LTD.

	产品规格书/specification	No	LL-3-J-33251
		版本Revision	A.1
	存货编码/Stock code.: 30103040012	页码Page	9 of 10
		日期Date	2020-9-24

11. 包装要求/Packing requirements:

11-1: 每个吸塑盒里放100PCS电机, 包装盒尺寸为248*203*10

100pcs/pallet, pallet size:248*203*10mm

11-2: 每21个包装盒用胶带捆成一捆, 数量为2000PCS.

21pallets/bundle, Qty:2000pcs

11-3: 每捆装入一个内箱里面, 数量为2000PCS. 内箱尺寸为260*220*175

1bundles/inner box, Qty:2000pcs. box size:260*220*175

11-4: 每两个内箱放入一个外箱里, 外箱尺寸为470*275*185

2 inner-box/outer-box, box size:470*275*185 mm

11-5: 外箱封箱, 数量和生产批次, 均注明在外箱上面.

Seal the outer box and indicate the quantity, Lot No. on it.

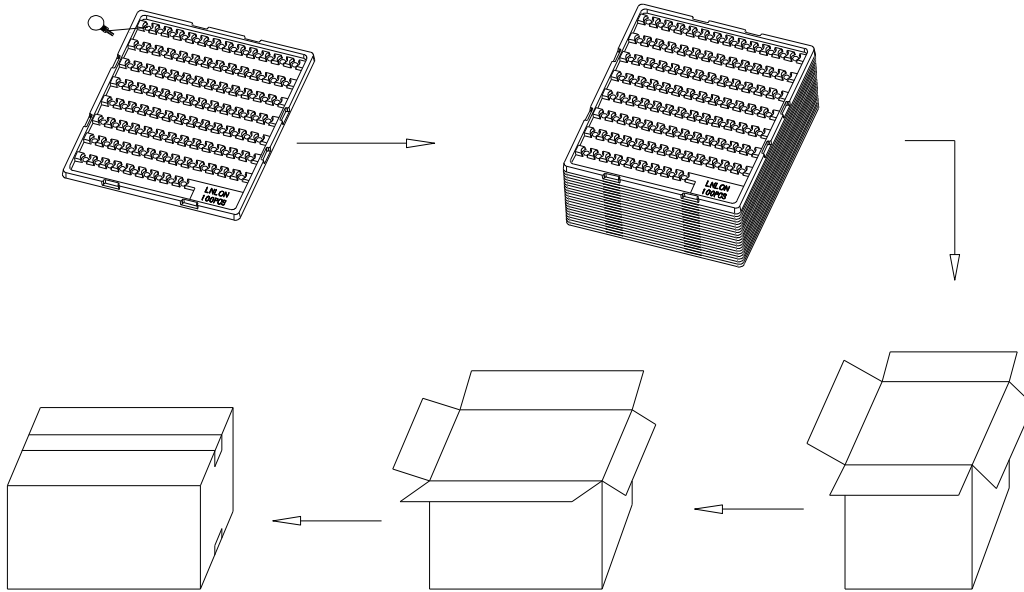

11-6 包装试验要求/Packing test requirements:

(1) 标准: 整箱重量 $\leq 9\text{kg}$, 跌落高度设定为75cm; 整箱重量 $> 9\text{kg}$ 但 $\leq 23\text{kg}$, 跌落高度设定为60cm。

Standard: Gross weight $\leq 9\text{kg}$ Fall height is 75cm; Gross 9kg $<$ weight $\leq 23\text{kg}$ Fall height is 60cm.

(2) 试验方法: A、每面跌落1次, 共6次; B、任选三条同一角的棱, 各跌落一次, 共3次。

Test method: A、Fall one time per face, six times in total; B、Chose eight arris and fall one time each, three times in total.

(3) 判定基准: 经过跌落试验后, 产品外观、性能无不良。

Judgement: After the fall test, the appearance and the performance are both passed.

	产品规格书/specification	No	LL-3-J-33251
		版本Revision	A.1
	存货编码/Stock code.: 30103040012	页码Page	10 of 10
		日期Date	2020-9-24

12. 使用注意事项说明/Matters to be paid attention to when using motor

12-1 电机在运输过程中应小心轻放，避免碰撞敲击引起的电机机身和性能受损。

Please place the motors carefully in transportation to avoid any damage to the motor body or its electric function because of collision.

12-2 电机不能在高温、高湿、带有腐蚀性气体的环境中贮存和使用，否则有可能导致电机的性能下降。

Please don't leave and use the motors in the environment of high temperature, high humidity and corrosion gas, or it would cause the function to fall down.

12-3 不能长时间用外力锁死振动轮，以免烧坏线圈，电机不能工作。

Please don't lock up the vibrating wheel, or the coil would be burned up and the motors can't operate.

12-4 避免接触或靠近强磁性物体，否则有可能导致电机性能下降。

Please prevent from magnetic objects, or it may cause the function fall down.

12-5 请在6个月内使用，在使用时和打开包装时，请避免水气凝结。

Please use the motors within six months and prevent them from coagulation of moisture when open the package and use them.