

Parameters Subject to Change Without Notice

DESCRIPTION

The JW[®]1769A/B/C is a constant current LED regulator with high current accuracy which applies to single stage step-down power factor corrected LED drivers. 600V power MOS is integrated, which can significantly simplify the design of LED lighting system.

High accuracy of output current is achieved by sampling the output current directly. Critical conduction mode operation reduces the switching losses and largely increases the efficiency. JW1769A/B/C is supplied from the output directly, and auxiliary winding is not needed.

JW1769A/B/C has multi-protection functions which largely enhance the safety and reliability of the system, including VCC over-voltage protection, VCC UVLO, short-circuit protection, LED open protection, cycle-by-cycle current limit and over-temperature protection.

Company's Logo is Protected, "JW" and "JOULWATT" are Registered Trademarks of JoulWatt technology Inc.

FEATURES

- No auxiliary winding
- 600V high voltage MOSFET integrated
- EMI friendly
- High current accuracy of line and load regulation
- High power factor with low output current-ripple
- Critical conduction mode
- High efficiency over wide operating range
- Cycle-by-cycle current limit
- LED short protection
- LED open protection
- Over-temperature protection
- Compact SOP7 package

APPLICATIONS

- Non-isolation Offline LED driver

TYPICAL APPLICATION

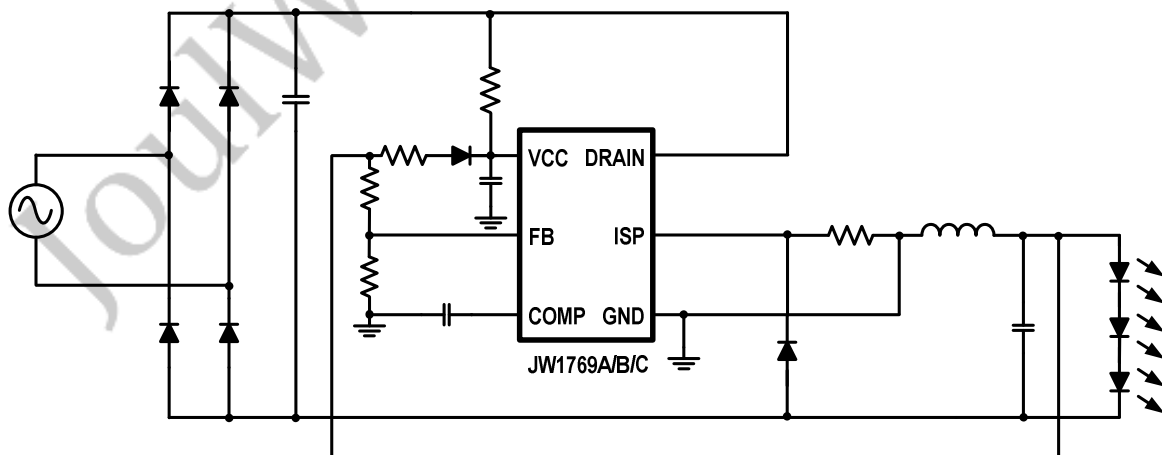

ORDER INFORMATION

LEAD FREE FINISH	TAPE AND REEL	PACKAGE	TOP MARKING
JW1769ASOPA#PBF	JW1769ASOPA#TRPBF	SOP7	JW1769A
JW1769BSOPA#PBF	JW1769BSOPA#TRPBF	SOP7	JW1769B
JW1769CSOPA#PBF	JW1769CSOPA#TRPBF	SOP7	JW1769C

Note:

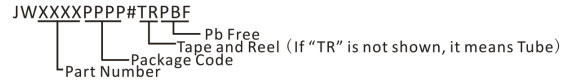

PIN CONFIGURATION

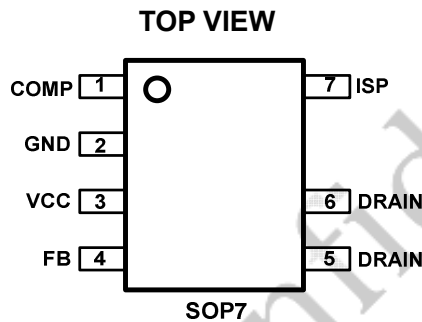

ABSOLUTE MAXIMUM RATING¹⁾

VCC PIN.....	43V
All other pins.....	-0.3V to 4.5V
Junction Temperature ^{2) 3)}	150°C
Lead Temperature.....	260°C
Storage Temperature.....	-65°C to +150°C
ESD Susceptibility (Human Body Model)	2kV

RECOMMENDED OPERATING CONDITIONS

FB PIN	1.6V to 2.6V
Operating Junction Temp(T _J).....	-40°C to 125°C

THERMAL PERFORMANCE⁴⁾

	θ_{JA}	θ_{JC}
SOP7	96.....	45°C/W

Note:

- 1) Exceeding these ratings may damage the device.
- 2) JW1769A/B/C guarantees robust performance from -40°C to 150°C junction temperature. The junction temperature range specification is assured by design, characterization and correlation with statistical process controls.
- 3) The JW1769A/B/C includes thermal protection that is intended to protect the device in overload conditions. Thermal protection is active when junction temperature exceeds the maximum operating junction temperature. Continuous operation over the specified absolute maximum operating junction temperature may damage the device.
- 4) Measured on JE51-7, 4-layer PCB.

ELECTRICAL CHARACTERISTICS

V_{IN} = 20V, T_A = 25°C, unless otherwise stated.

Item	Symbol	Condition	Min.	Typ.	Max.	Units
V _{CC} Turn-On Voltage	V _{CC_ON}		18	21.0	24	V
V _{CC} Turn-off Low Voltage	V _{CC_OFF_L}		6.4	7	8	V
V _{CC} Hysteresis	V _{CC_HYS}	V _{CC_ON} -V _{CC_OFF_L}		14		V
V _{CC} Clamp	V _{CC_CLP}			35		V
V _{CC} Shunt Regulator Current Limit	I _{CC_SHUNT}	V _{CC} = 42V	4	6	8	mA
V _{CC} Quiescent Current	I _Q	V _{CC} <V _{CC_ON}	26	31	36	uA
FB Pin High Threshold	V _{FB_H}		2.75	2.9	3.05	V
V _{ISP} Sample Value	V _{ISP}		96	100	104	mV
V _{ISP} Max Voltage			500	550	610	mV
Leading Edge Blanking Time	T _{LEB}		500	750	1000	ns
Maximum Frequency	F _{MAX}			140	160	kHz
Maximum MOS On Time	T _{ONMAX}			30		us
MOS Saturation Current	JW1769A	I _d	V _{gs} =10V	4		A
	JW1769B			10		
	JW1769C			8		
MOS R _{dson}	JW1769A	R _{dson}	V _{gs} =10V		6.8	Ω
	JW1769B				1.8	
	JW1769C				3.5	
Breakdown Voltage	JW1769A	BV		600		V
	JW1769B			600		
	JW1769C			600		

PIN DESCRIPTION

Pin	Name	Description
1	COMP	Compensation Pin for Internal Error Amplifier. Connect a capacitor between the pin and GND to compensate the internal feedback loop.
2	GND	Ground.
3	VCC	Power Supply Pin. This pin supplies current to the internal start-up circuit. This pin must be bypassed with a capacitor nearby.
4	FB	Voltage Loop Feedback Pin. FB is used to detect LED open by sampling the output voltage.
5,6	DRAIN	DARIN of the MOSFET.
7	ISP	Output Current Sense Pin. The pin is used for output current control.

BLOCK DIAGRAM

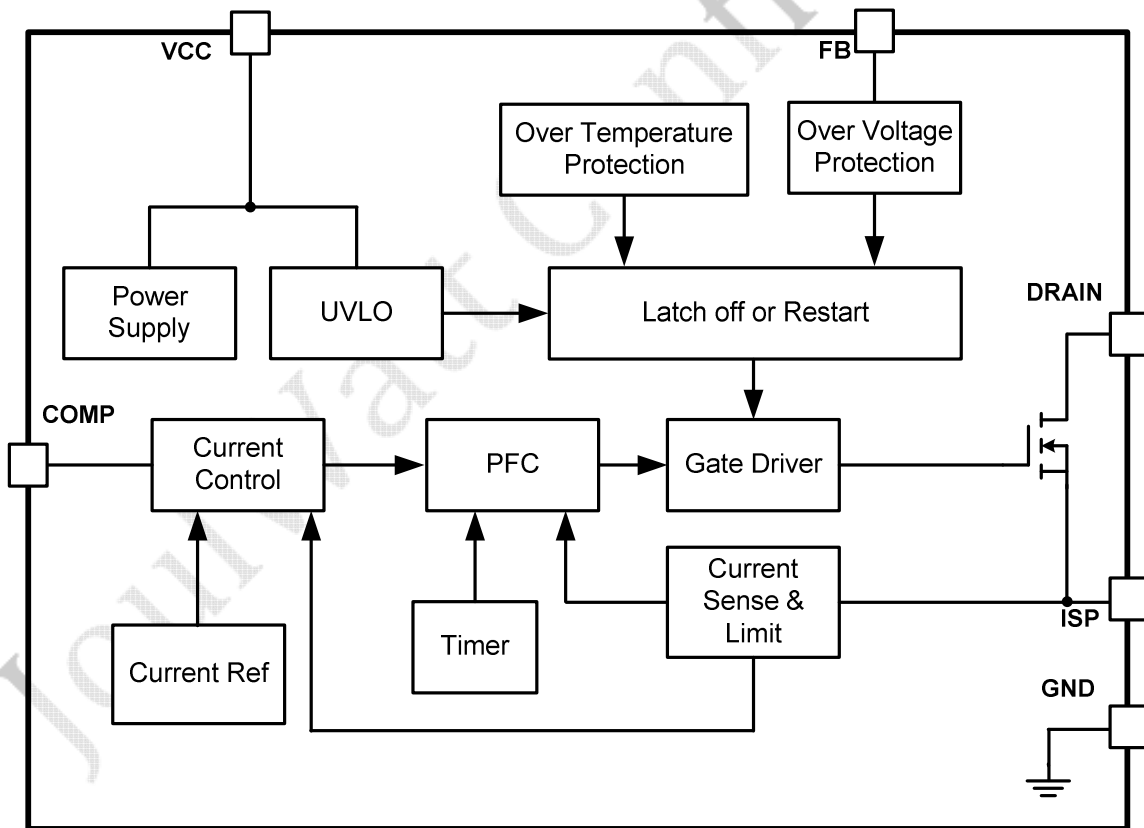

TYPICAL PERFORMANCE CHARACTERISTICS

$V_{IN}=85VAC\sim 264VAC$, $V_{OUT}=75V$, $I_o=120mA$, ,unless otherwise noted

Efficiency

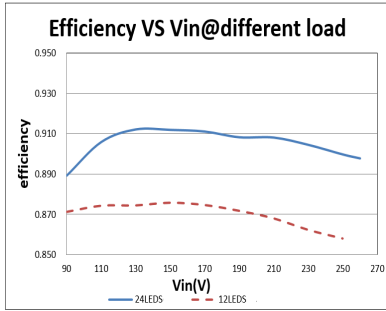

Line regulation

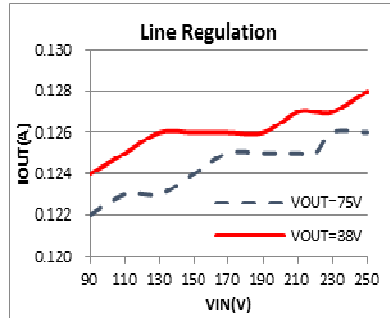

PF

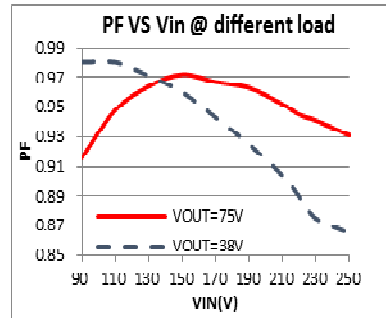

THD

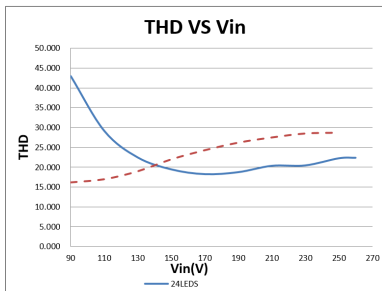

Start State

$V_{IN}=90Vac, I_o=120mA, P_o=9.8W$

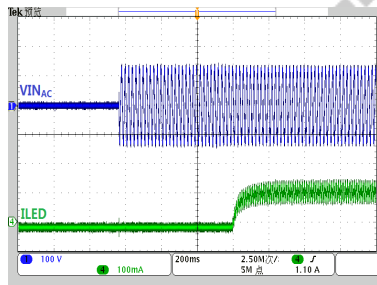

Steady State (Input)

$V_{IN}=220Vac, I_o=120mA, P_o=10W$

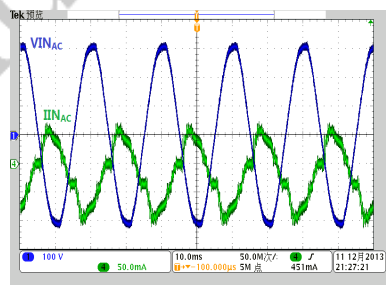

Steady State (Output)

$V_{IN}=220Vac, I_o=120mA, P_o=10W$

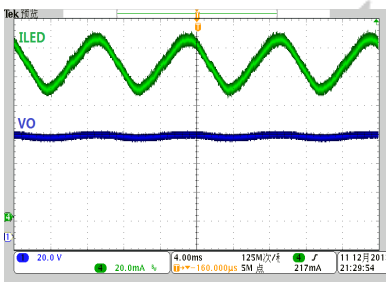

Short Circuit Protection

$V_{IN}=220Vac, I_o=102mA, P_{IN}=0.39W$

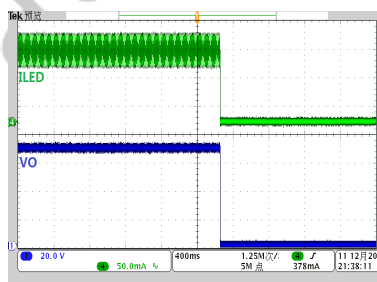

Open Circuit Protection

$V_{IN}=220Vac, V_o=80V, P_{IN}=0.25W$

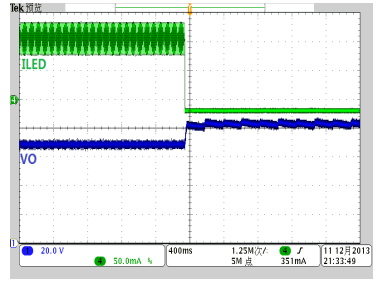

Output current VS. Junction Temperature

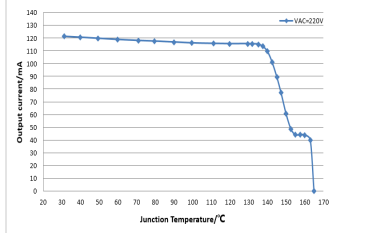

FUNCTIONAL DESCRIPTION

The JW1769A/B/C is a constant current LED regulator which applies to non-isolation step-down LED system with power factor correction. 600V power MOS is integrated, which can significantly simplify the design of LED lighting system. JW1769A/B/C can achieve excellent line and load regulation, high efficiency and low BOM cost.

Start Up

When the pull-up resistor charges VCC up to 21V, the gate drive signal begins to switch, and the output begins to provide power to the VCC pin when the output is enough. An internal voltage clamp is attached to the VIN pin to prevent VCC from being too high. An internal 5mA current pulls the VCC down when it is above 35V. When VCC is lower than 7V, it stops switching.

Loop Compensation

An integrator configuration is applied to the output current feedback loop with a capacitor connected to the COMP pin. For offline applications, the crossover frequency should be set much less than the line frequency of 120Hz or 100Hz. To have a good PFC performance, a capacitor of 0.47μF connected to COMP pin is recommended.

Constant Current Control

The JW1769A/B/C controls the output current from the information of the current sensing resistor. The output LED mean current can be calculated as:

$$I_{LED} = V_{ISP} / R_{CS} \quad (A)$$

Where

V_{ISP}—100mV typically;

R_{CS} – The sensing resistor connected between ISP and GND.

Critical Conduction Mode Operation

JW1769A/B/C works in the critical conduction mode of the inductor current. When the internal power MOSFET turns on, the inductor current begins to increase from zero. The turn on time of the MOSFET can be calculated as:

$$T_{ON} = I_{PK} \times L / (V_{IN} - V_{LED})$$

Where,

L –inductance.

I_{PK} – peak current in one switch period.

V_{IN}– input voltage after rectification and filtering.

V_{LED} – output LED voltage.

When the power MOSFET turns off, the inductor current begins to decrease. The power MOSFET turns on again when the inductor current is zero. The turn off time of the MOSFET can be calculated as:

$$T_{OFF} = I_{PK} \times L / V_{LED}$$

And the inductance of the system can be calculated as:

$$L = V_{LED} \times (V_{IN} - V_{LED}) / (f \times I_{PK} \times V_{IN})$$

Where, f is the switching frequency. You may choose the minimum input voltage when you want to set up the minimum switching frequency.

Inductor selection guide:

Output current(mA)	Inductor(mH)
120	1.30
180	1.00
240	0.83
320	0.73

LED Over Temperature Protection

When JW1769A/B/C junction temperature is higher than 135°C, the output current starts to decrease. It drops to 1/3 of the original setting current at 155°C. Then the current remains until the junction temperature is over 165°C. Once the junction temperature is over 165°C, the current drops to zero.

LED Open Protection

The output voltage can be detected by the FB pin. When the FB voltage is higher than 3.0V, the LED open protection is triggered and the power MOSFET gate driver stops switching. After several seconds, the gate driver starts switching again.

The recommended FB pin voltage is about 2.5V at rated output, and its pull-up resistor is typically in hundreds K Ω level.

LED short protection

JW1769A/B/C judges LED short from the FB voltage. During a shorted LED condition, JW1769A/B/C reduces the internal command current to a very low level and slows down the switching frequency to 1.25 kHz to decrease the output current.

If LED short or LED open protection are false triggered by unreasonable PCB layout, a 20pF capacitor paralleled to FB pin and GND can solve the problem.

PCB Layout Guidelines

1. The VCC pin must be locally bypassed with a capacitor.
2. Make the area of the power loop as small as possible in order to reduce the EMI radiation.
3. The chip should be far away from the heating components, such as MOSFET, transformer and diode.
4. Note the chip ground is not connected to the cathode of the input capacitor as usual.

REFERENCE DESIGN

VIN: 90VAC~264VAC
 VOUT: 40~70V
 IOUT: 240mA
 PF: >0.9

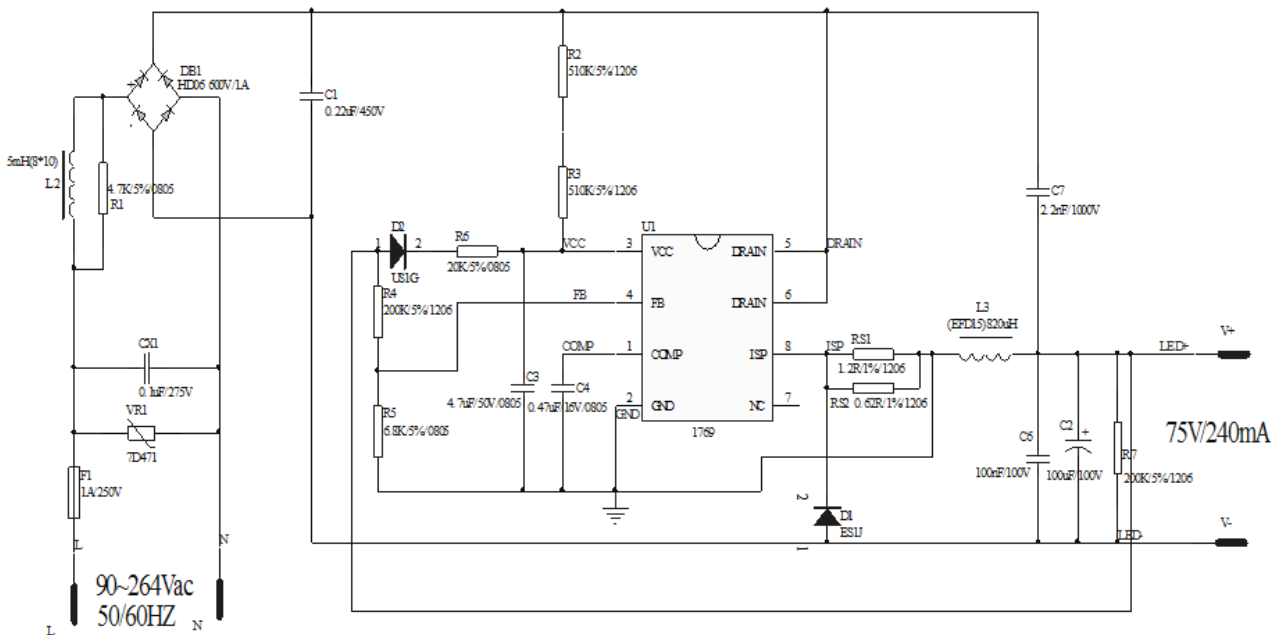

JoulWatt

PACKAGE OUTLINE

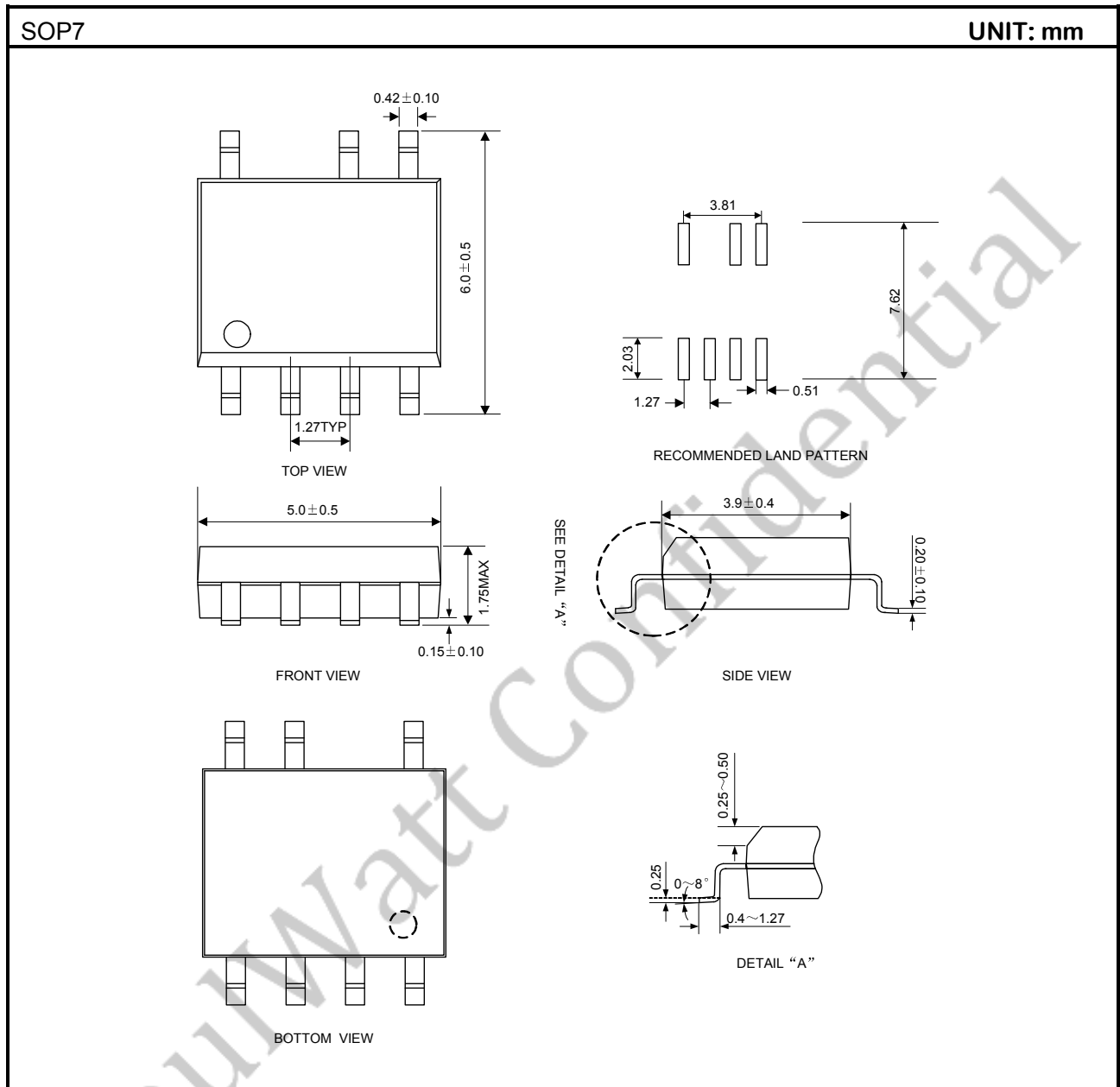

IMPORTANT NOTICE

- Joulwatt Technology Inc. reserves the right to make modifications, enhancements, improvements, corrections or other changes without further notice to this document and any product described herein.
- Any unauthorized redistribution or copy of this document for any purpose is strictly forbidden.
- Joulwatt Technology Inc. does not warrant or accept any liability whatsoever in respect of any products purchased through unauthorized sales channel.

JoulWatt Confidential

Copyright © 2015 JW1769A/B/C Incorporated.

All rights are reserved by Joulwatt Technology Inc.