

### 239 Series, 5x20 mm, Slo-Blo® Fuse



#### Description

5x20mm Slo-Blo® glass body cartridge fuse designed to UL specification.





#### Features

- Designed to UL/CSA/ ANCE 248-1 and 248-14 Standards
- Available in cartridge and axial lead format
- RoHS compliant and lead-free

#### Applications

Used as supplementary protection in appliance or utilization equipment to provide individual protection for components or internal circuits.

#### Agency Approvals

Agency	Agency File Number	Ampere Range	
	Cartridge: NBK030609-JP1021A NBK190609-JP1021A NBK030609-JP1021B	1A – 3.5A 4A – 5A 7A	
	Leaded: NBK030609-JP1021C NBK190609-JP1021B NBK030609-JP1021D	1A – 3.5A 4A – 5A 7A	
		SU05001 – 2004A SU05001 – 2014A	0.200A – 3.15A 4A – 7A
		E10480	0.080A – 7A
	29862	0.200A – 3.15A 4A – 7A	
	N/A	0.080A – 7A	

#### Electrical Characteristics for Series

% of Ampere Rating	Ampere Ratings	Opening Time
100%	All Ratings	4 hours, Minimum
135%		1 hour, Maximum
200%		2 minutes, Maximum

#### Additional Information



**Datasheet**



**Resources**



**Samples**



**Accessories**

For recommended fuse accessories for this product series, see '[Recommended Accessories](#)' section.

# Axial Lead & Cartridge Fuses

5x20 mm > Slo-Blo® Fuse > 239 Series

## Electrical Characteristic Specification by Item

Amp Code	Amp Rating (A)	Voltage Rating (V)	Interrupting Rating	Nominal Cold Resistance (Ohms)	Nominal Melting I <sup>2</sup> t (A <sup>2</sup> sec)	Agency Approvals				
						UL	SP	PS E	CCC	CE
.080	0.08	250	35A @ 250 VAC 10kA @ 125 VAC	28.1750	0.02500	x				x
.100	0.1	250		17.3425	0.05500	x				x
.125	0.125	250		11.6000	0.08500	x				x
.150	0.15	250		8.1000	0.13000	x				x
.200	0.2	250		3.8725	0.16500	x	x		x	x
.250	0.25	250		3.0700	0.34000	x	x		x	x
.300	0.3	250		2.3000	0.61500	x	x		x	x
.400	0.4	250		1.4750	2.02000	x	x		x	x
.500	0.5	250		0.9090	1.98500	x	x		x	x
.600	0.6	250		0.6990	2.41500	x	x		x	x
.700	0.7	250		0.5375	4.12000	x	x		x	x
.750	0.75	250		0.4710	5.42500	x	x		x	x
.800	0.8	250		0.4155	7.56500	x	x		x	x
001.	1	250		0.2965	11.29500	x	x	x	x	x
1.25	1.25	250	10kA @ 125 VAC 100A @ 250 VAC	0.1980	19.52500	x	x	x	x	x
01.6	1.6	250		0.1205	30.43000	x	x	x	x	x
002.	2	250		0.0943	50.58500	x	x	x	x	x
02.5	2.5	250		0.0583	79.70500	x	x	x	x	x
003.	3	250		0.04877	129.51000	x	x	x	x	x
3.15	3.15	250		0.0414	128.05000	x	x	x	x	x
03.2	3.2	250		0.0385	128.05000	x		x		x
03.5	3.5	250		0.0370	128.05000	x		x		x
004.	4	125	10kA @ 125 VAC	0.0312	270.703	x	x	x	x	x
005.	5	125		0.0199	302.836	x	x	x	x	x
007.	7	125		0.0114	305.758	x	x	x	x	x

### Temperature Re-rating Curve

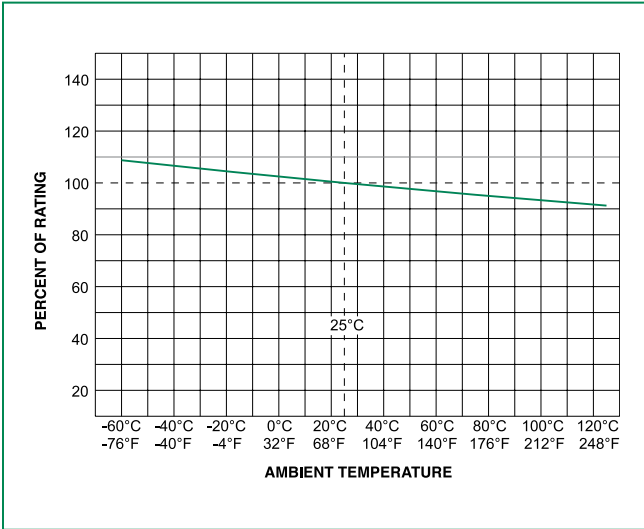

Note:  
Re-rating depicted in this curve is in addition to the standard derating of 25% for continuous operation.

### Average Time Current Curves

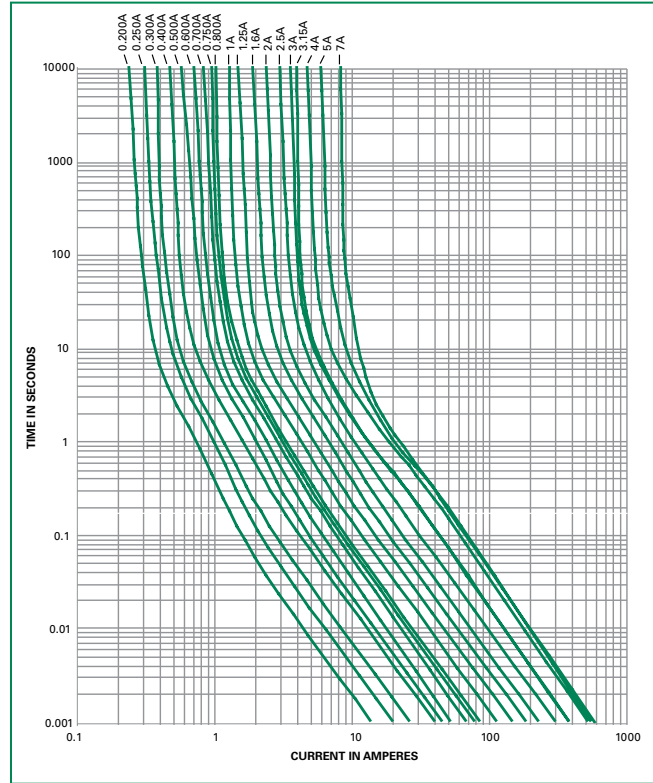

### Soldering Parameters - Wave Soldering

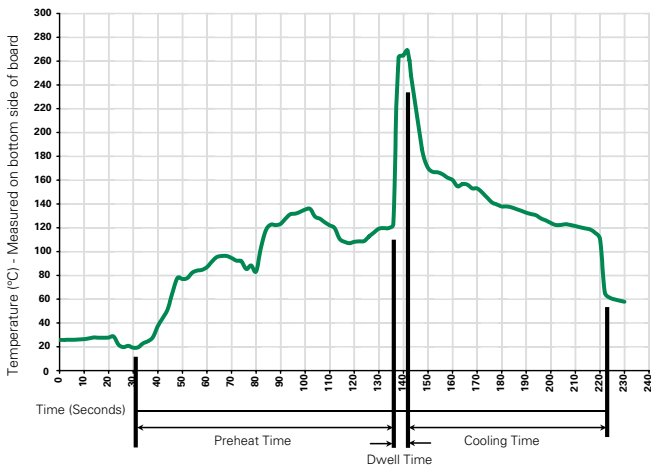

### Recommended Process Parameters:

Wave Parameter	Lead-Free Recommendation
<b>Preheat:</b> (Depends on Flux Activation Temperature)	(Typical Industry Recommendation)
Temperature Minimum:	100°C
Temperature Maximum:	150°C
Preheat Time:	60-180 seconds
<b>Solder Pot Temperature:</b>	260°C Maximum
<b>Solder Dwell Time:</b>	2-5 seconds

### Recommended Hand-Solder Parameters:

Solder Iron Temperature: 350°C +/- 5°C  
Heating Time: 5 seconds max.

**Note: These devices are not recommended for IR or Convection Reflow process.**

# Axial Lead & Cartridge Fuses

5x20 mm > Slo-Blo® Fuse > 239 Series

## Product Characteristics

<b>Materials</b>	Body: Glass Cap: Nickel-plated brass Leads: Tin-plated Copper
<b>Terminal Strength</b>	MIL-STD-202, Method 211, Test Condition A
<b>Solderability</b>	MIL-STD-202 Method 208
<b>Product Marking</b>	Cap 1: Brand logo, current and voltage rating Cap 2: Series and agency approval markings

<b>Operating Temperature</b>	-55°C to +125°C
<b>Thermal Shock</b>	MIL-STD-202, Method 107, Test Condition B: (5 cycles -65°C to +125°C)
<b>Vibration</b>	MIL-STD-202, Method 201
<b>Humidity</b>	MIL-STD-202, Method 103, Test Condition A. high RH (95%) and elevated temp (40°C) for 240 hours
<b>Salt Spray</b>	MIL-STD-202, Method 101, Test Condition B

## Dimensions

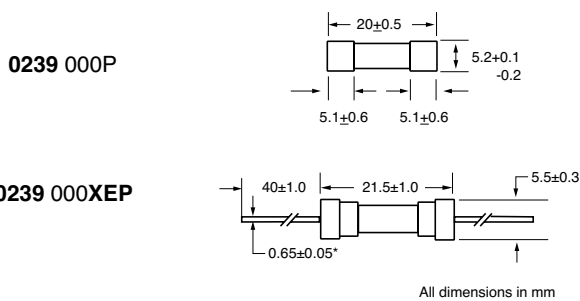

Notes:  
\* Ratings above 6.3A have 0.8±0.05 diameter lead.

## Part Numbering System

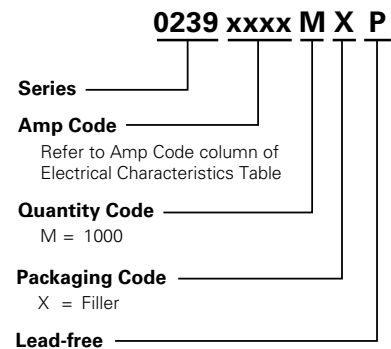

## Packaging

Packaging Option	Packaging Specification	Quantity	Quantity & Packaging Code	Taping Width
<b>239 Series</b>				
Bulk	N/A	1000	MX	N/A
Bulk	N/A	1000	MXE	N/A
Reel and Tape	EIA 296-E	1000	MRET1	T1=52mm (2.062")
Bulk	N/A	1000	MXB	N/A
Bulk	N/A	100	HX	N/A
Bulk	N/A	100	HXE	N/A

## Recommended Accessories

Accessory Type	Series	Description	Max Application Voltage	Max Application Amperage
Holder	<a href="#">345_ISF</a>	Panel Mount Shock-Safe Fuseholder	250	10
	<a href="#">345</a>	Shock-Safe Fuseholder with PC Mount, Solder Mount and Panel Mount options		20
	<a href="#">830</a>	PC Mount Shock-Safe Miniature Fuseholder		16
Block	<a href="#">520</a>	Metric OMNI-BLOK® Fuse Block		10
	<a href="#">646</a>	PC Mount Miniature Fuse Block		6.3
	<a href="#">658</a>	Surface Mount Miniature Fuse Block		10
Clip	<a href="#">520_WV</a>	PC Mount Miniature Fuse Clip		6.3
	<a href="#">111</a>	PC Board Mount Fuse Clip		10
	<a href="#">445</a>	PC Board Mount Fuse Clip		10

Notes:  
1. Do not use in applications above rating.  
2. Please refer to fuseholder data sheet for specific re-rating information.  
3. Please contact factory for applications greater than the max voltage and amperage shown.