

## FEATURES

- Fast Switching Speed
- For General Purpose Switching Applications
- High Conductance

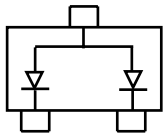

BAW56 Marking: A1

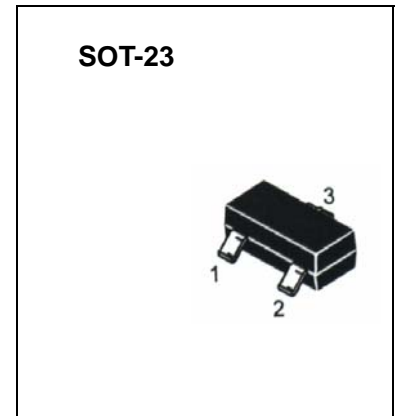
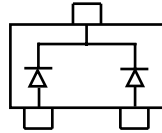

BAV70 Marking: A4

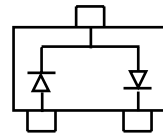

BAV99 Marking: A7

## Maximum Ratings @ $T_A=25^\circ\text{C}$

Parameter	Symbol	Limits	Unit
Reverse voltage	$V_R$	70	V
Forward Current	$I_F$	200	mA
Peak Forward Surge Current	$I_{FM(surge)}$	500	mA
Power Dissipation	$P_D$	225	mW
Thermal Resistance Junction to Ambient Air	$R_{\theta JA}$	556	$^\circ\text{C}/\text{W}$
Junction temperature	$T_J$	150	$^\circ\text{C}$
Storage temperature range	$T_{STG}$	-55-150	$^\circ\text{C}$

## Electrical Characteristics @ $T_A=25^\circ\text{C}$

Parameter	Symbol	Min.	Typ.	Max.	Unit	Conditions
Reverse Breakdown Voltage	$V_R$	70			V	$I_R=100\mu\text{A}$
Forward voltage	$V_{F1}$			0.715	V	$I_F=1\text{mA}$
	$V_{F2}$			0.855	V	$I_F=10\text{mA}$
	$V_{F3}$			1	V	$I_F=50\text{mA}$
	$V_{F4}$			1.25	V	$I_F=150\text{mA}$
Reverse current	$I_R$			2.5	$\mu\text{A}$	$V_R=70\text{V}$
Capacitance between terminals	$C_T$			1.5	pF	$V_R=0, f=1\text{MHz}$
Reverse recovery time	$t_{rr}$			6	ns	$I_F = I_R = 10\text{mA}$ , $I_{rr} = 0.1 \times I_R, R_L = 100\Omega$

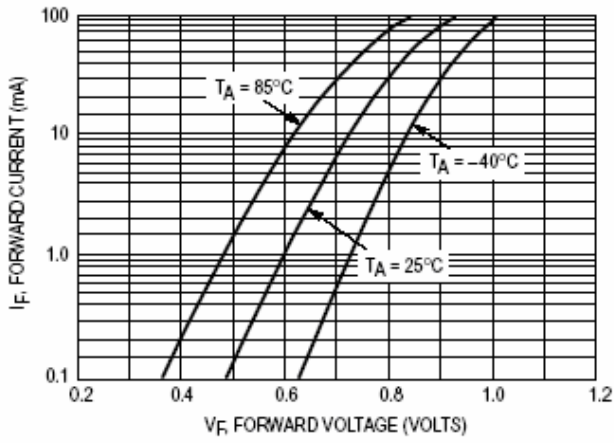

Figure 1. Forward Voltage

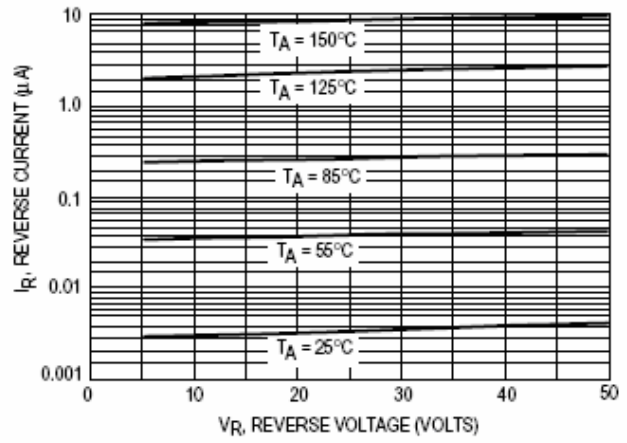

Figure 2 Leakage Current

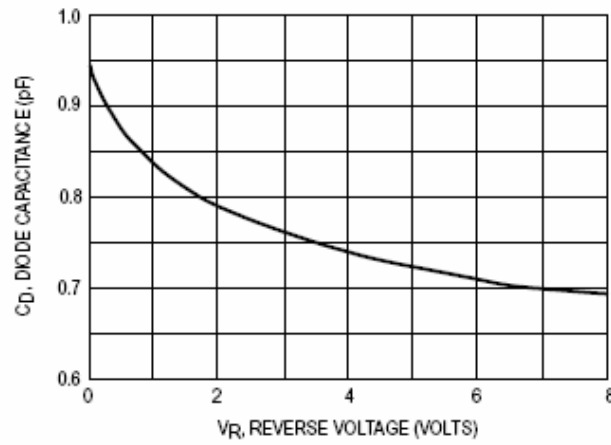

Figure 3 Capacitance